

CATALOG No. 7.0

7.0

WESTWIND

— MANUFACTURERS OF —
DOORS, DRAWERS & MOLDING

Highest In Quality



— FULL ILLUSTRATIONS AND DESCRIPTIONS OF THE ENTIRE LINE OF —
EXCEPTIONAL VALUES IN HIGH GRADE CABINET DOORS, DRAWERS & MOLDING

719.466.4373 • WESTWINDWOOD.NET

Go West!

Mission Statement

Not just making a living,
but making a difference as we...

Glorify God

Operate with Integrity

Work Towards Excellence

Exceed Expectations

Serve Others

Invest In **T**echnology

WESTWIND

— MANUFACTURERS OF —
DOORS, DRAWERS & MOLDING

But seek ye first the kingdom of God, and His righteousness; and all these things shall be added unto you.

Matthew 6:33

Welcome. 2
General Information 3-6
Wood Species List 7
Frame Profiles. 8-12
Raised Panel Profiles 14-19
Beaded Panel Options 20
Edge Profiles 21-26
Edge Profiles (8000 Series). 27-30
Door Styles. 31-38
Drawer Front Options 39
Wainscoting 41
Miter Door & Drawer Styles 42-54
Slab Styles 55
Applied Molding Styles 56-59
Micro Rail Slab Door Profiles 60-63
Door Options. 64-68
Dovetail Drawer Boxes. 69-70
Order Forms for Doors and Drawers 71-74
Molding, Finer Details. 75
Base Profiles 76-85
Case Profiles. 86-90
Cove Profiles 92-97
Crown Profiles 98-110
Miscellaneous Profiles 111-122
Tongue & Groove Profiles 123-124
Matching Outside Edge Profiles 125-127
Wood Characteristics 128-130
Order Forms. 131-132

Thank you for choosing Westwind Wood Specialties for your high quality cabinet components. We look forward to serving you. We place high value on Customer Care, and will do everything possible to assist you in any way we can. To begin this new business relationship, please complete this form and fax or email it to us at your earliest convenience. This information is necessary to set up your account and to avoid any unnecessary delays. Once we have received this form back from you, our Customer Care Team will contact you. Please fax to 719-466-4375 or email to sales@westwindwood.net.

Date:

NEW CUSTOMER INFORMATION FORM				
Business Name:				
Do You Have A Sales Tax Exemption?		If Yes, Please Email Or Fax.		
Decision Maker:			Email Address:	
Mailing Address 1:				
Mailing Address 2:				
City, ST, Zip:				
Phone:			Mobile Number:	
Fax:			Alt Phone:	
Shipping Address 1 <i>(if different than mailing address)</i> :				
Shipping Address 2:				
City, ST, Zip:				
Alternate Contact:			Email Address:	
Desired Lead Time:			Delivery Hours:	
Send Acknowledgements via:	<input type="checkbox"/> Email	<input type="checkbox"/> Fax	<input type="checkbox"/> Mail	
Email Address:				
Send Invoices via:	<input type="checkbox"/> Email	<input type="checkbox"/> Fax	<input type="checkbox"/> Mail	
Email Address:				
Requested Terms:	<input type="checkbox"/> CC	<input type="checkbox"/> E-Check	<input type="checkbox"/> COD-Check	<input type="checkbox"/> Open
Requested Credit Limit:				

Comments:

CREDIT POLICY

There are several ways that Westwind receives payment. New customers may be subject to a 50% down payment until check authorization or credit application has been approved.

Credit Card: This method is available to all customers. Credit card payments made to invoices over 10 days old will be subject to a 5% handling fee. Westwind accepts Visa, Master Card, American Express and Discover.

E-Check and Company Check: Fill out and return a check authorization form and email or fax it to us at **719.466.4375**. All orders placed before we process this form will be on a cash basis. Upon approval, company checks will be accepted. Westwind does accept E-Checks for your convenience. Please call our accounting department if you have any questions concerning this method of payment.

Open Account: To be approved for open account, fill out a credit application form and email or fax it to us at **719.466.4375**. Upon approval, terms will be net 30.

Past Due Accounts: All past due invoices will be subject to a **2%** finance charge per month. Any accounts that are 45 days past due will be switched to a temporary C.O.D. basis until the account is brought current. Trade discounts are subject to change when the customer is outside the agreed upon terms. Any special problems or concerns should be brought to the attention of the Credit Department as soon as possible to set up any special payment terms. Any account that goes past 90 days will be returned permanently to COD.

CUSTOMER CARE TEAM

Office Hours: Customer Care Representatives are available Monday thru Thursday from 7:00 a.m. to 4:30 p.m. and Friday 8:00 a.m. to Noon MST. They can be reached at **866.754.2275** or direct **719.466.4373** and will be ready to assist with any questions, quotes, or concerns that you may have.

Holiday Schedule: Westwind is closed on the following holidays: New Years Day, Memorial Day, Independence Day, Labor Day, Thanksgiving Day and the Friday following, and Christmas Day.

PLACING ORDERS AND CONFIRMATION

Door Orders will be accepted as "Finished Size" only. Westwind does NOT pull sizes off of blueprints.

There are several options to choose from when placing orders. Details are listed below. Orders can be placed in metric or standard measure. **To minimize chances of error and misunderstanding; Westwind recommends using online, email, or fax.**

Online: Online ordering is available 24/7. It is necessary to register prior to placing online orders and quotes. Upon registration, you will receive a short demo/training and the proper credentials required to get on the site. Once registered, go to www.westwindwood.net. Click on "Ordering" then click the "Order Online" icon. This will take you to Westwind's online ordering site. Once there, enter your username and password in the proper places. This will allow you into Westwind's system.

E-mail: E-mail is available 24/7. If necessary, please call to have an interactive PDF order form e-mailed or go to our website and download one there. The general e-mail address for our Customer Care Team is: **sales@westwindwood.net**.

Fax: Our fax machine is available 24/7 to receive both orders and quote requests. The number is **719.466.4375**.

Mail: Orders may be sent by mail. We will schedule the order when it arrives. Because of the uncertainty of the postal system, we cannot hold a spot open for you until it arrives by mail. If this method is chosen, our mailing address is:

Westwind Wood Specialties, 33645 United Ave, Pueblo, CO 81001

Phone: Westwind will take orders by phone. **All sizes must be given Width X Height.** The order will be read back to you. Once the order has been read back to you, it is your full responsibility. Any mistakes will be your responsibility.

Order Confirmation: All email, fax, and phone orders will be confirmed by email or fax within 24 hours. If you do not receive a confirmation within 24 hours, please call our Customer Care Team. Do not resend your order without communication to them. This may/will result in duplicate orders. If you are instructed to resend the order, please indicate that it is a resent order on the form.

Order Forms: Order forms are included in this catalog. Please photocopy forms and use them when placing an order. Interactive PDF order forms are also available on our website. Please complete our order form thoroughly and legibly when placing an order to minimize errors.

Quotes: Our Customer Care Team is available to assist you with quotes upon request. They will return a quote to you as expeditiously as possible. All prices are based on the current cost of labor and materials and are good for 30 days from the date of the quote.

If quote only, please make sure to clearly indicate "Quote Only" on your forms.

Computer Forms: When using computer generated forms, i.e. Cabinet Vision, KDC, etc, it is the customer's responsibility to complete all of the other details pertaining to the job.

LEAD TIMES AND SCHEDULING

Standard Scheduling (Doors and Drawers): Standard products will be manufactured in 7 – 10 days

Specialty and Custom Scheduling: This refers to special and custom products offered by Westwind; which include Lite Doors, Rough Sawn, Wirebrush, AP and OE doors. Please allow 12 – 15 working days on these orders. Lead time on orders with non-stock lumber requirements, custom profiles, and other doors that do not appear in the catalog, will be established when the order is confirmed.

EXPEDITED ORDER REQUESTS

Westwind will attempt to expedite orders if possible. However, if it would affect the lead time of other existing orders, we may not be able to do so. Therefore, we reserve the right to limit quantities on expedited orders. Expedite lead times and upcharges.

2-day Expedite	100%	} <u>Remember, this depends upon expedite capacity at the time of order.</u>
4-day Expedite.....	50%	
Non-Standard.....	25%	

PRICING

Call the office, or go to www.westwindwood.net. Click on "Ordering" then click the "Order Online" icon. Once you log in to your account, you can key a bid for pricing.

MINIMUM MATERIAL CHARGES:

Doors and Drawer Fronts: Minimum material charge on all doors and drawer fronts is 1 square foot. Doors can be made smaller, but the square footage minimum will be charged. Contact our customer care team for special quotes on orders of fifty or more doors of identical style, size, and wood species. Large orders of drawer fronts or small doors may be subject to an upcharge.

Drawer Boxes: Minimum material charge on all drawer boxes is 1 square foot. Drawer boxes may be built smaller, but the square foot minimum will be charged.

Price Changes: **Westwind reserves the right to change any or all prices without notice.**

DOOR SPECIFICATIONS

Standard Door Thicknesses: Westwind offers many different door thicknesses. All standard cope and stick doors finish at .780" thick. Non-standard thicknesses include .750", .8125", .840", .875" and 1". All miter doors finish at .780" thick. Please contact customer care for custom thickness requests.

Standard Frame Dimensions: Standard frame widths are 2 ¼" on standard cope and stick profiles. All standard miter dimensions are shown on pages 46-57.

Non-Standard Parts: Doors can be ordered with frame parts ranging in width from 2" to 5 7/8" in 1/8" increments. Any frame part that is not 2 ¼" will be upcharged. Any frame part over 6" will have to be entered as a wainscot.

Rules for door style maximum sizes:

1. Doors that have any frame parts wider than 6" will be priced as a wainscoting panel.
2. All door styles with vertical grain (incl. 401,402), that are wider than 36" and/or taller than 96" will be priced as a wainscoting panel.

DETAILING

Sanding: Doors shipped from Westwind are sanded to 180 grit finish front and back, and all cross sanding marks are removed. The pricing in this catalog reflects this sanding process. We expect the doors to be ready for finish; however we recommend that you lightly sand the doors upon arrival ensuring a consistent finish to the cabinetry.

REPLACEMENTS

Replacement products will be remade and shipped as quickly as possible. Errors made by Westwind will be replaced and reshipped at no charge. Errors made by the customer will be charged regular price including shipping.

SHIPPING

Westwind offers three different methods of shipping. Size of order, service, and timing determine which method of shipping will be used. The customer may also request which method they prefer. All shipments are F.O.B., Pueblo, CO. The freight charges will appear on your invoice. Westwind will not be responsible for any delays caused by the freight carrier.

Delivery: We offer delivery to a wide range of areas throughout Colorado and Kansas. We will attempt to schedule a delivery to your location when it is feasible. Westwind reserves the right to change deliveries as needed.

Common Carrier or Truckline: All shipments with a large number of pieces can be shipped by common carrier. Common carriers experience much less damage than parcel services. If you have a way to handle a heavy crate (forklift, skid steer, etc.) and the truck can be unloaded quickly, truckline is a good option.

Parcel Services: All other shipments that don't fit the above categories will be shipped with a parcel service (UPS, FedEx Ground, etc.). This method is always an option. Parcel services do have size restrictions on them. Please call the office for restrictions and pricing. Length and girth are determined by measuring the length of the product to ship, and adding it to the circumference of the width.

Will Call: Orders can be picked up at our facility Monday thru Thursday 8:00 a.m. to 4:30 p.m. MST. If special arrangements need to be made, please call and we will try to accommodate. Any order left in "will call" over 10 days may be subject to a \$30.00/day storage fee.

Shipping Damage: All products that are damaged in shipping should be reported to Westwind as soon as possible. We will replace the item at no cost to you and will file any claims that are necessary. **It is required that all of the steps below are followed to ensure successful resolution to any freight claim.**

- All damage to the exterior of the package must be noted on the Bill of Lading.
- Take pictures of all damage to exterior packages and keep all packaging material.
- Photos of damaged product and packaging are required to file a claim.
- Contact a Customer Care Representative immediately and submit all information in order to file a claim.
- Do not throw away packaging until claim has been resolved.
- Sending us a photo only of a damaged product is not sufficient information.

Missing Pieces: All products are inspected and counted prior to shipment. Please count all pieces immediately upon receipt, and compare to the packing list total. Notify Westwind of any missing pieces. If we do not hear from you within a week after delivery, all missing pieces will become the customer's responsibility.

TOLERANCES

Size: Westwind warrants the overall size of all doors and drawer fronts to within +/- 1/32".

Mitered and Applied Molding Door Joints: All doors will expand and contract as they adapt to their surroundings. The joints on these doors will open and close as they acclimate. Therefore, a gap of .010" is considered appropriate. All doors should be kept in a climate controlled environment year round.

Veneer (MDF) Panel Doors: The panels in these doors are 1/4" veneered MDF. Though we take precautions to acquire the best available sheet goods, the veneer will not always match the frames. If your job requires a close color match, we recommend using a solid wood panel with the 680 panel profile (See page 19).

LIMITED WARRANTY

Westwind offers a one year warranty on all our standard products against faulty material and workmanship. This warranty covers the replacement of our product in an unfinished state as originally delivered. Westwind Wood Specialties will not be held responsible for delays caused by factors beyond our control, i.e. obstruction to or blockage of usual routes of transportation, unavoidable accident, riots, natural disasters, vehicle shortages, prevention of labor, power shortages, or lack of materials. Our liability under this warranty is limited to the invoice price of the products as sold by us. There are no other warranties of any kind, expressed or implied.

Veneer panels, although warranted to be of similar color, may not exactly match the solid wood frames.

Due to the inherent nature of wood, some expansion and contraction will occur according to the door size and the environmental conditions involved. For this reason, some movement, especially in the raised panels, is expected and may show up after finishing.

Westwind recommends using MDF center panels on all paint grade projects for the most stability against warping and twisting.

CONDITIONS OF LIMITED WARRANTY

For the purposes of this limited warranty a defective product is defined as any product manufactured by Westwind Wood Specialties which displays warpage, delamination, swelling, or twisting within one (1) year from the date of delivery when purchaser complies with each of the following mandatory conditions:

1. At all times purchaser must handle each product in a professional and workmanlike manner.
2. Reasonable care must be used in the selection, fitting, and applying of appropriate hardware to each applicable product.
3. Products shall not be stored or installed in a damp area such as a freshly plastered building or subjected to abnormal heat, dryness or humidity. Westwind recommends that all plaster and drywall finish dry at least 2 weeks prior to cabinet/door installation and that the temperature be at occupancy level.
4. All surfaces of each door must receive a uniform application of finish to prevent warpage caused by unequal absorption or release of moisture.
5. Each door must be painted, sealed, or varnished within 1 month of delivery.
6. Any product deemed to be defective must be returned to Westwind for inspection before a credit is applied.
7. Demands by the purchaser for the repair or replacement of the defective product under the limited warranty must be made in writing and received by Westwind within one year.

SPECIFIC LIMITATIONS OF WARRANTY

Westwind Wood Specialties limited warranty does not extend to the following situations:

1. Warpage or twisting of three-sixteenths (3/16") of an inch or less shall be considered acceptable and not a defect under the terms of limited warranty.
2. Any door having a width dimension of 30" or height dimension of 60" or more is expressly excluded from this limited warranty. Doors between 50" – 60" without a center rail are not guaranteed.
3. This limited warranty expressly excludes reimbursement to the purchaser for repair or replacement of defective products by any agent or workmen other than Westwind Wood Specialties.

PAINT GRADE MATERIALS WARRANTY

There is no warranty for PG Poplar frame with MDF panel. Poplar tends to warp and twist. For best stability we recommend and warranty PG Maple or Beech frames with MDF Panel.

LIABILITY

Westwind Wood Specialties, Inc. accepts no responsibility or liability for any of our products improperly installed.

Call or go online to get current pricing.

Our standard list of wood species follows:

Alder, MDF Panel	Cherry, Rustic	Red Oak, Quartered
Alder, Rustic	Cherry, Select	Red Oak, Rift
Alder, Select	Hard Maple, Birds-Eye	Red Oak, Rustic
Ash, Natural	Hard Maple, MDF Panel	Red Oak, Select
Ash, White	Hard Maple, Rustic	Sapele, Flat Sawn
Beech, MDF Panel	Hard Maple, White	Sapele, Qtr Sawn
Beech, Natural	Hickory, Heritage	Soft Maple, MDF Panel
Beech, Paintgrade	Hickory, Natural	Soft Maple, Paintgrade
Beech, Rustic	Hickory, Rustic	Soft Maple, White
Beech, Select	Hickory, Select	Soft Maple, Wormy
Birch, MDF Panel	Mahogany, African (Flat)	Walnut, Natural
Birch, Natural	Mahogany, African (Ribbon)	Walnut, Premium
Birch, Rustic	MDF	Walnut, Rustic
Birch, Red	Pine, Clear	White Oak, Natural
Birch, Rustic Red	Pine, Knotty	White Oak, Quartered
Birch, White	Poplar, MDF Panel	White Oak, Rift Natural
Butternut, Natural	Poplar, Paintgrade	White Oak, Rustic
Cherry, Heritage	Poplar, Select	White Oak, Select
Cherry, Natural	Red Oak, Natural	

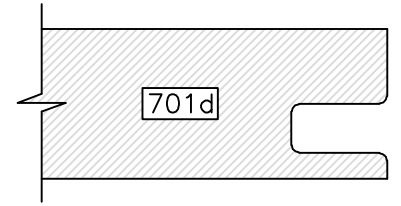
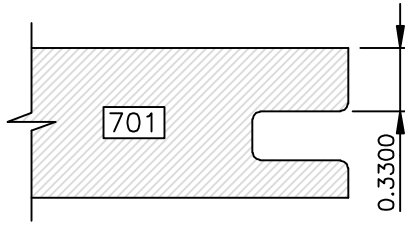
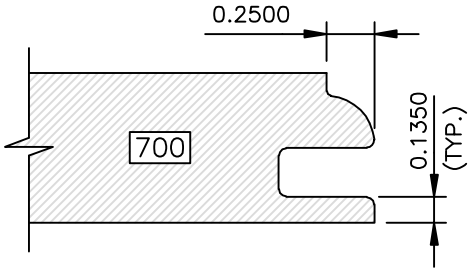

Caution: Please verify panel thickness compatibility when ordering 701 or 701d.

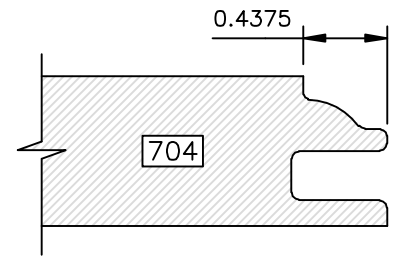
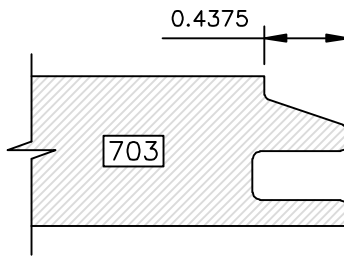
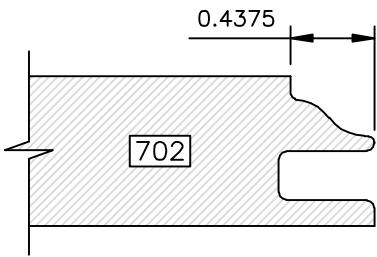

DRAWINGS ARE TO SCALE

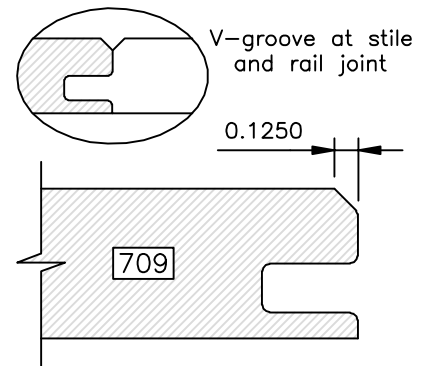
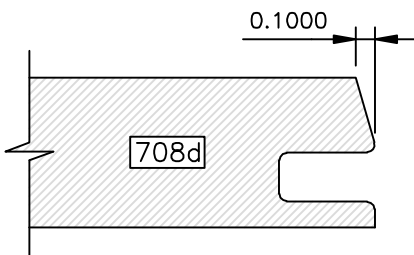
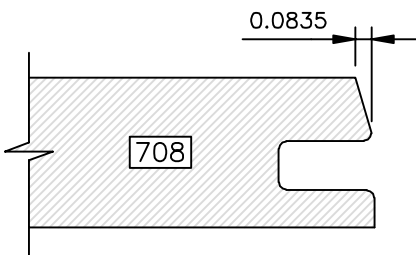
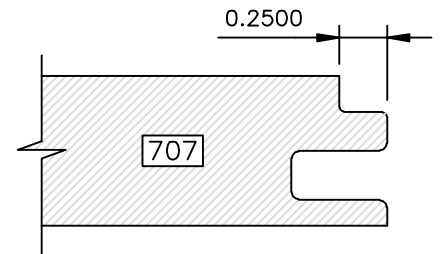
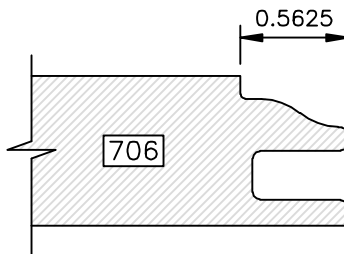
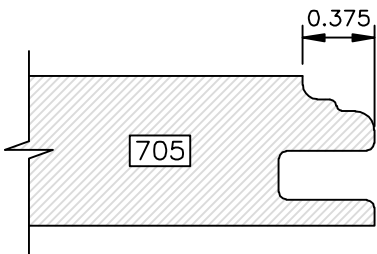

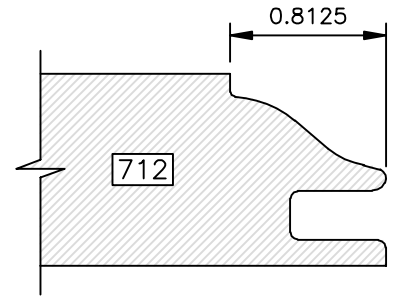
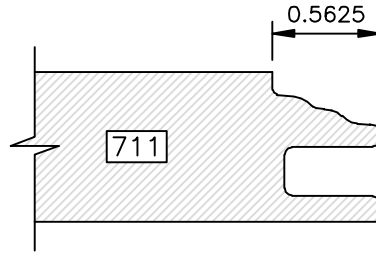
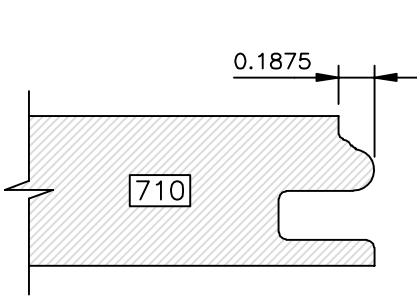

Available in 1" Thick Only

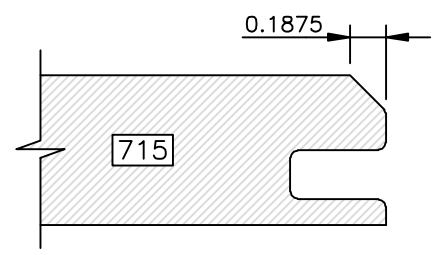
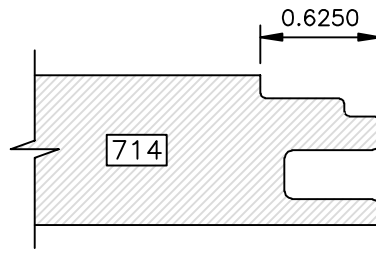
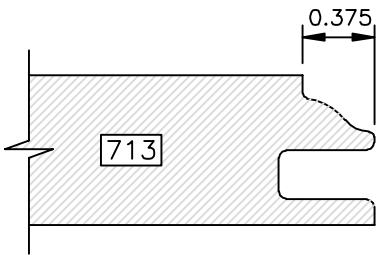

DRAWINGS ARE TO SCALE

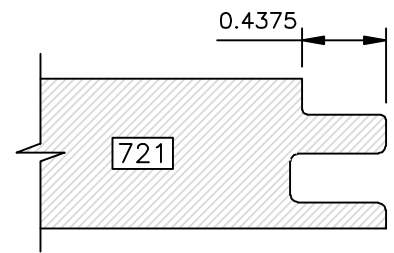
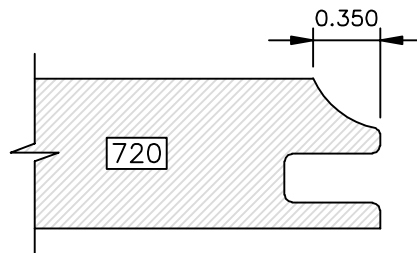
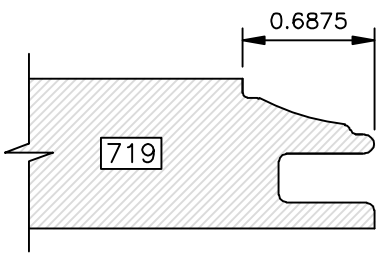
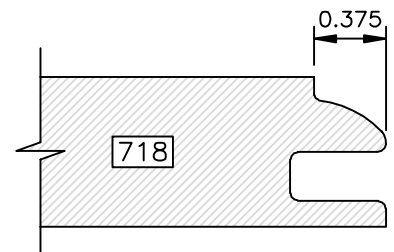
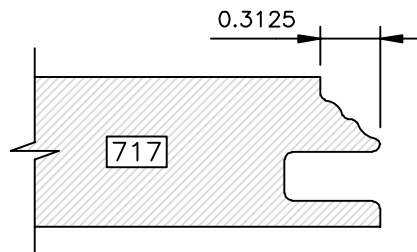
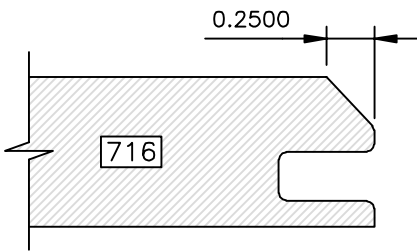

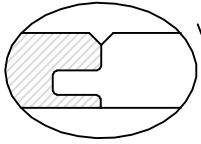

V-groove at stile
and rail joint

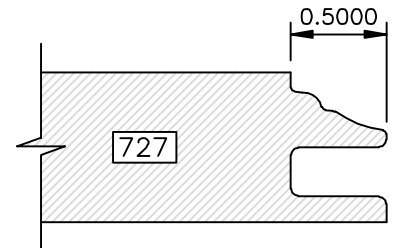
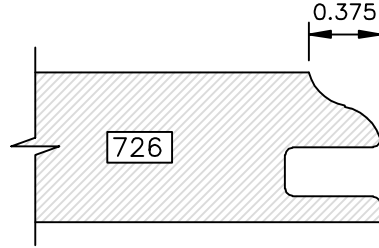
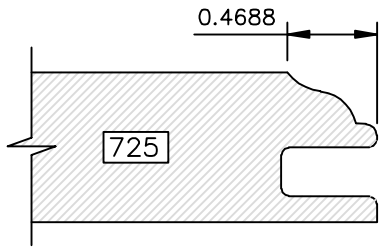
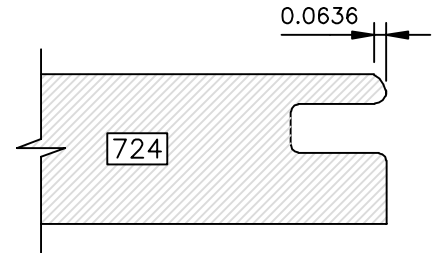
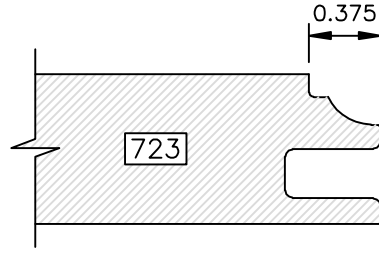
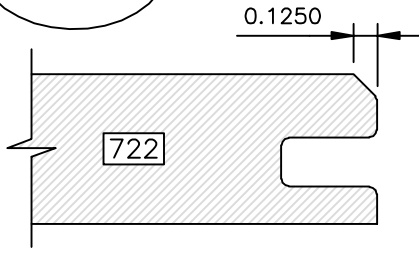

DRAWINGS ARE TO SCALE

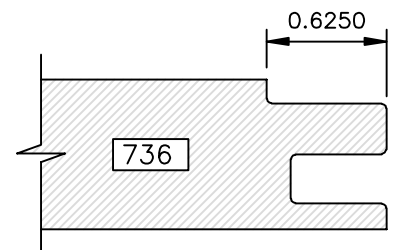
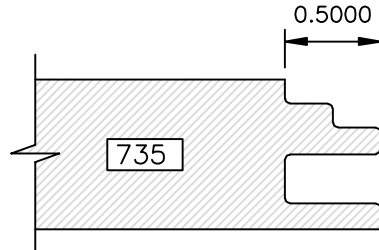
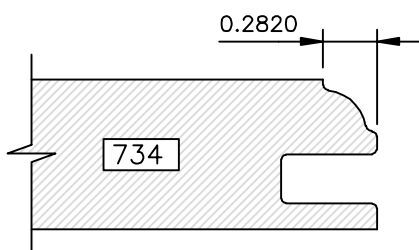
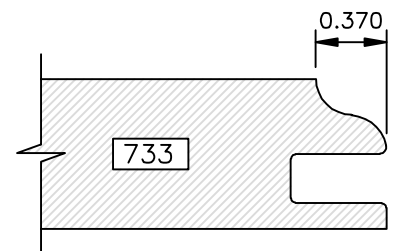
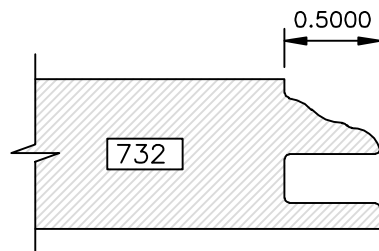
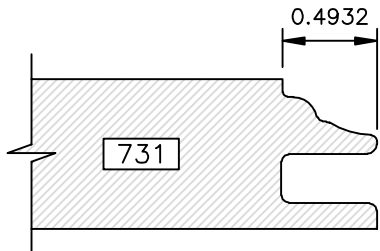

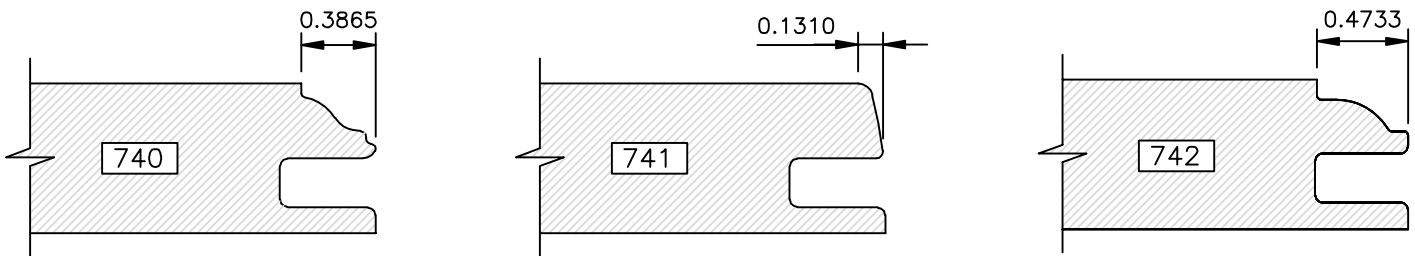
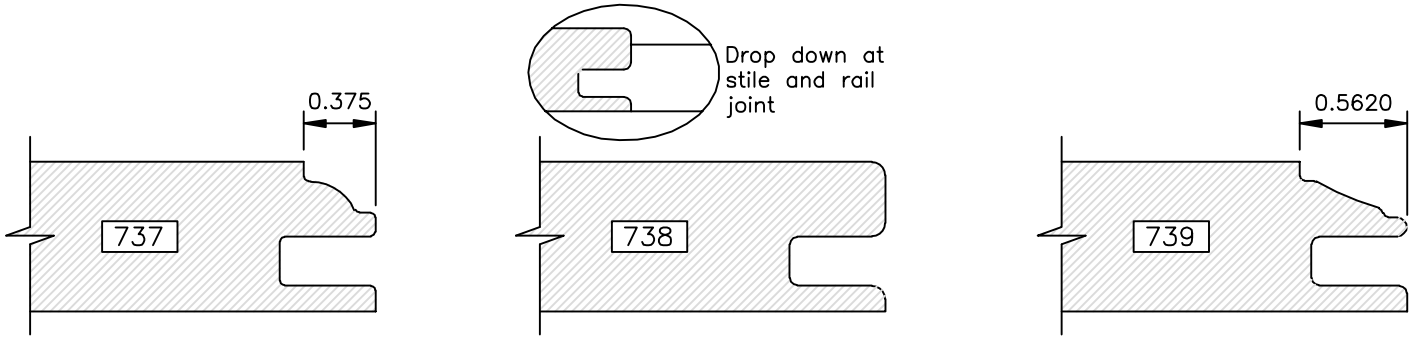

DRAWINGS ARE TO SCALE

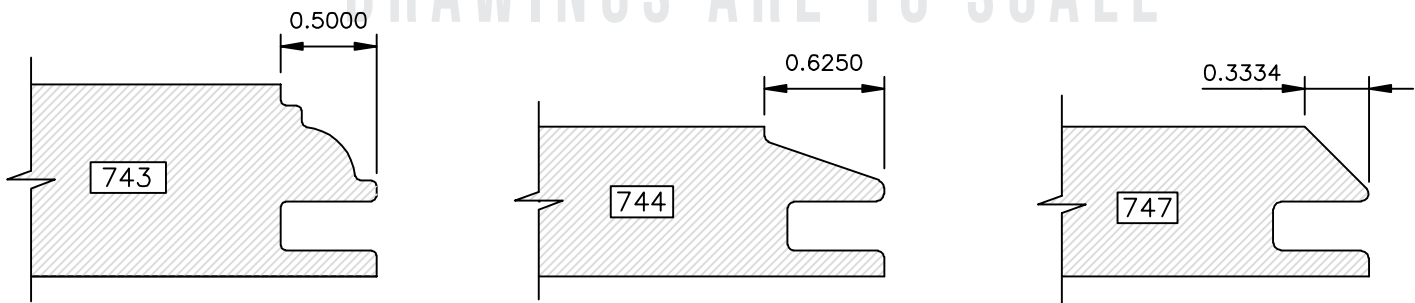

Available in 1" Thick Only

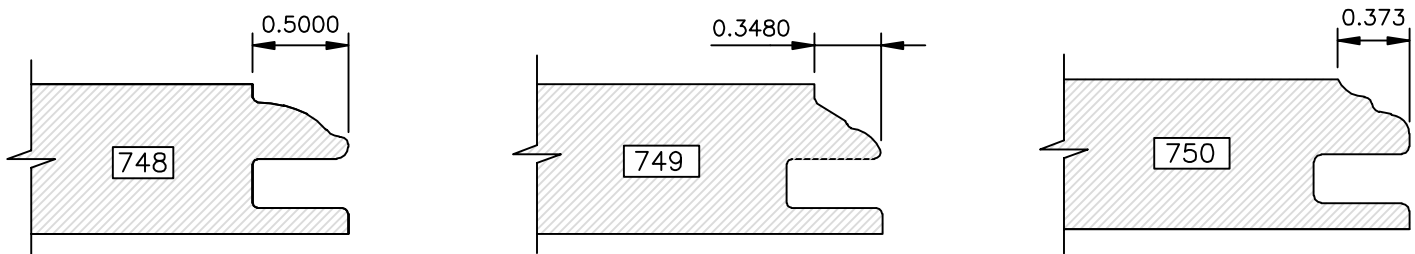

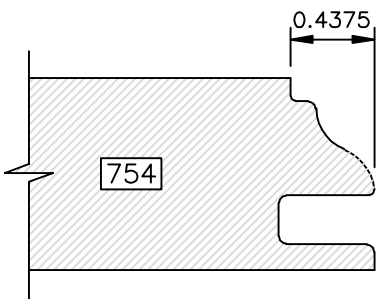
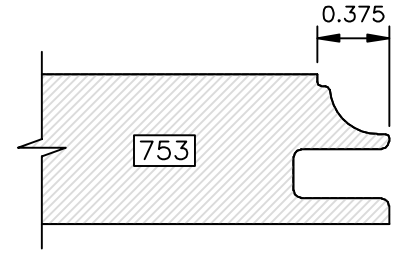
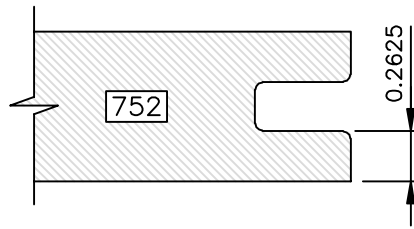
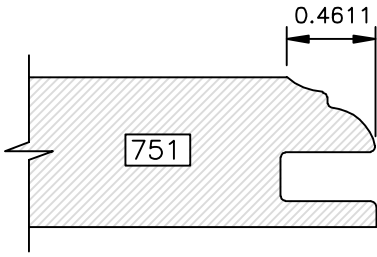

Available in 1" Thick Only

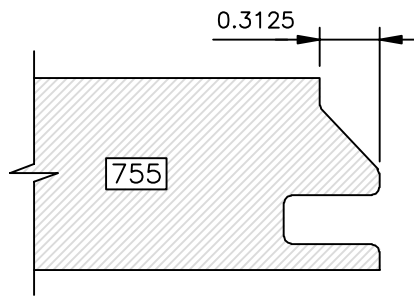

Available in 1" Thick Only

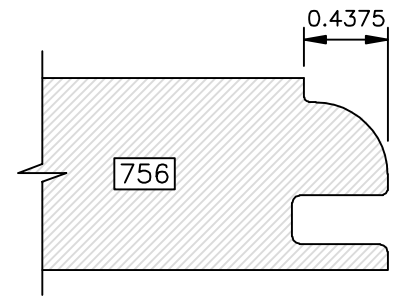

Available in 1" Thick Only

DRAWINGS ARE TO SCALE

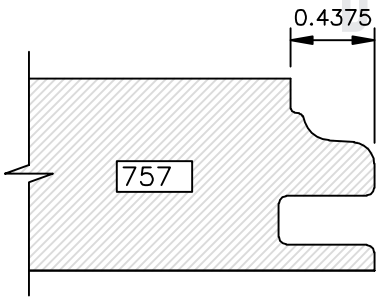

Available in 1" Thick Only

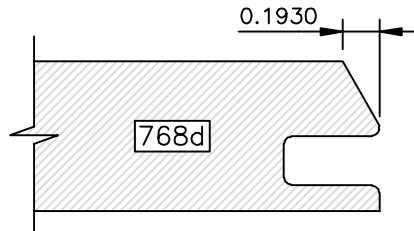
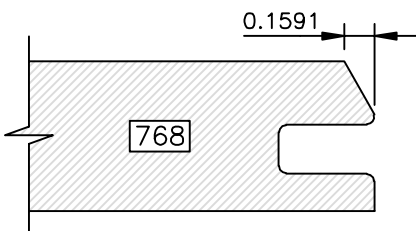
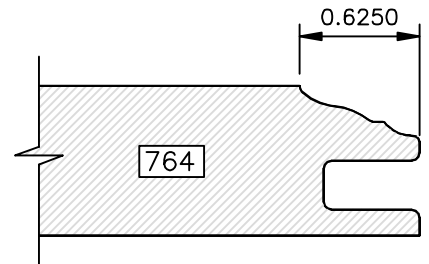
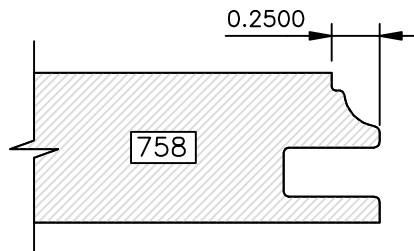

A large rectangular area of graph paper with a grid of small squares, intended for taking notes. The grid covers most of the page's width and height.

RAISED PANEL PROFILES

Go West!

When ordering veneer MDF panel, use 690 as the panel profile.

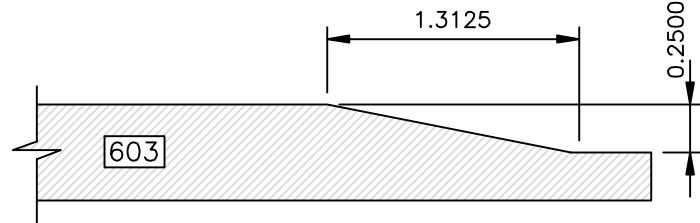
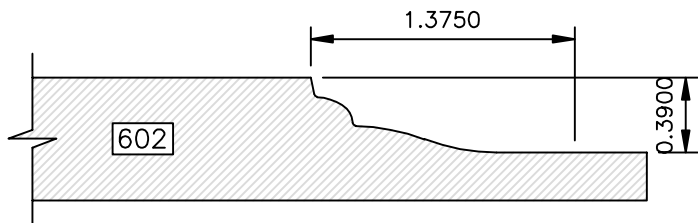
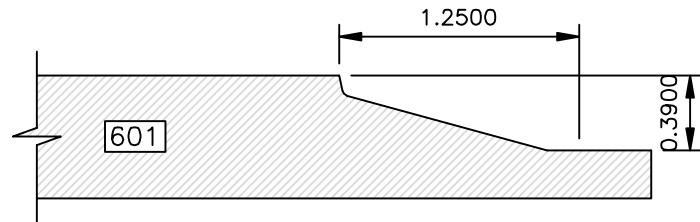
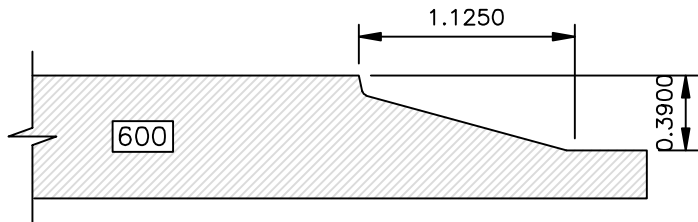

DRAWINGS ARE TO SCALE

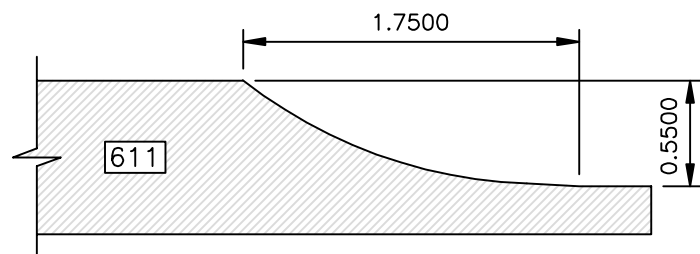
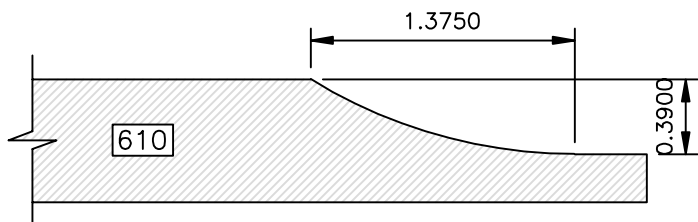
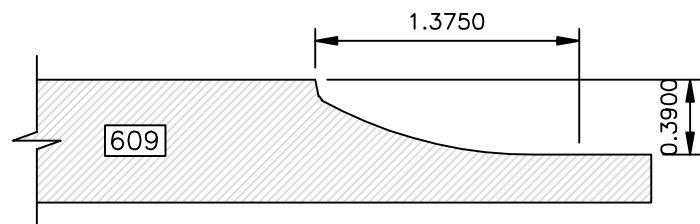
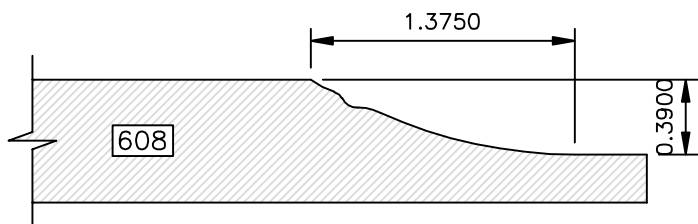
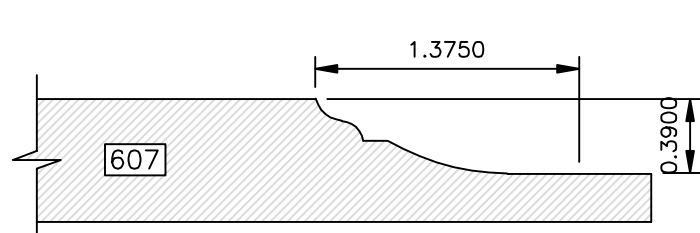
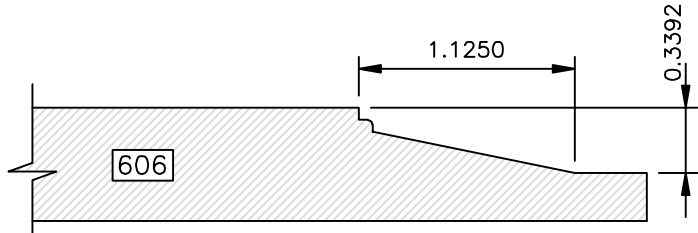
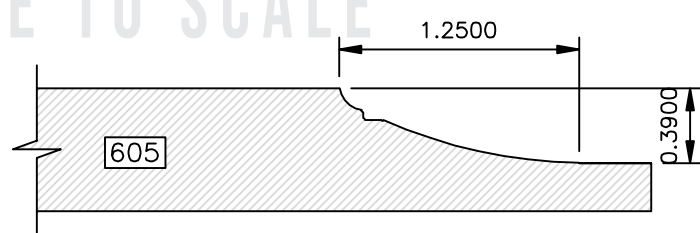
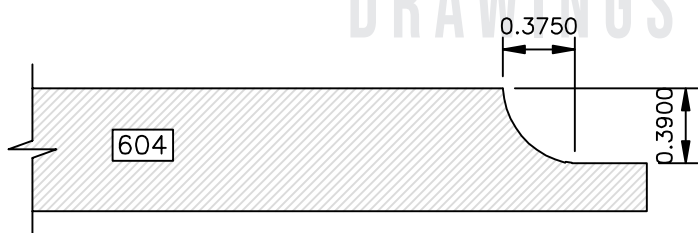

Available in 1" Thick Only

RAISED PANEL PROFILES

When ordering veneer MDF panel, use 690 as the panel profile.

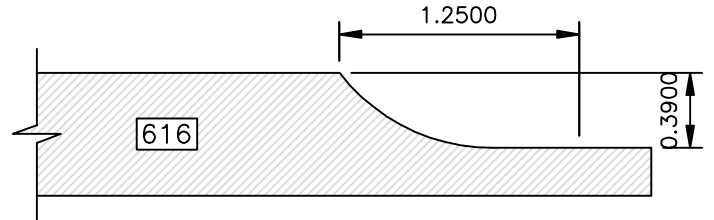
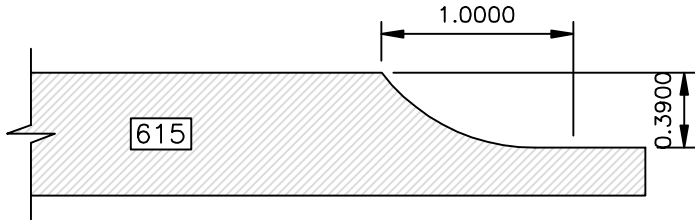
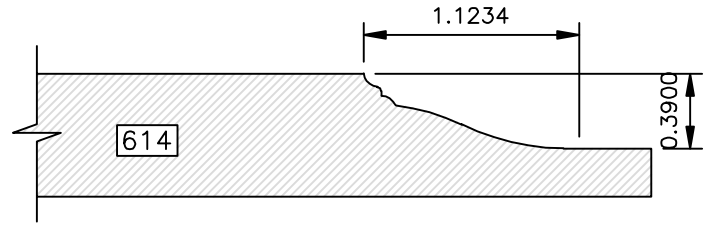
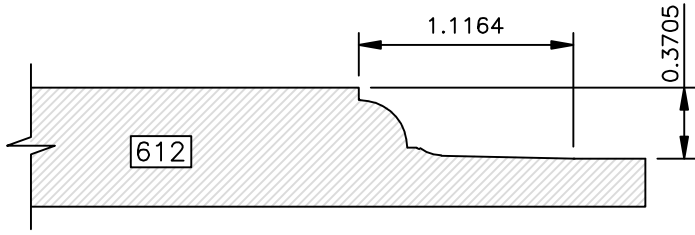

DRAWINGS ARE TO SCALE

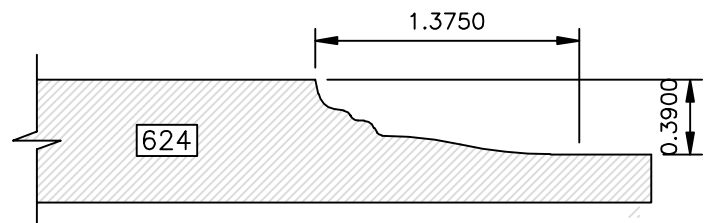
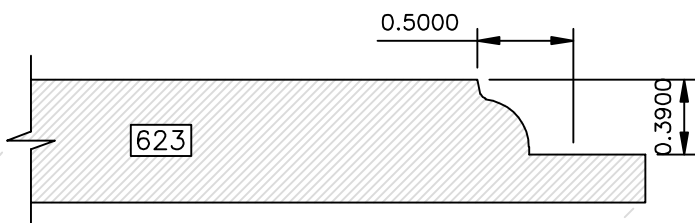
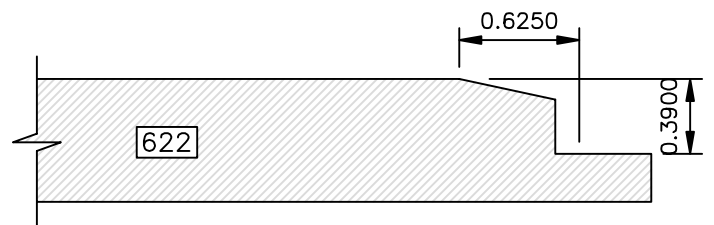
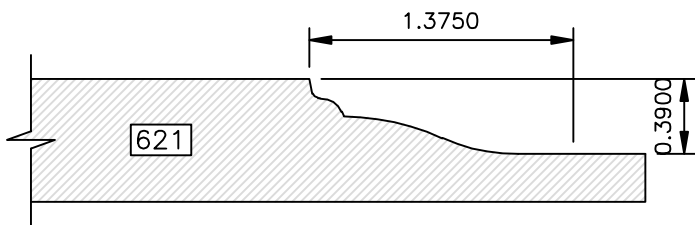
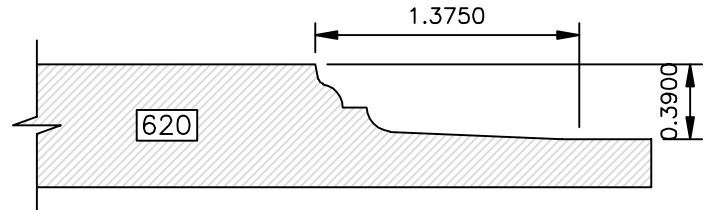
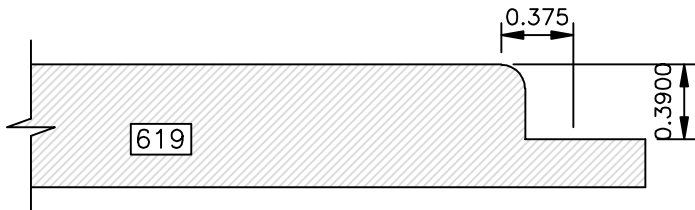
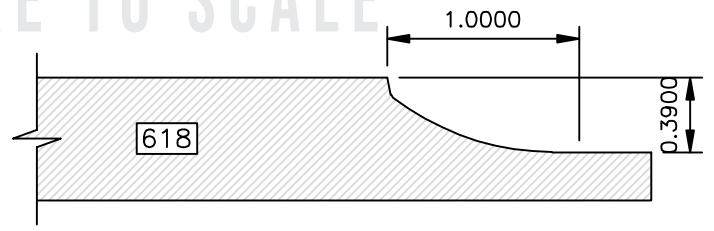
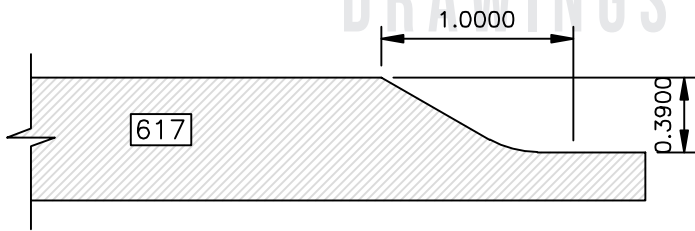

RAISED PANEL PROFILES

Go West!

When ordering veneer MDF panel, use 690 as the panel profile.

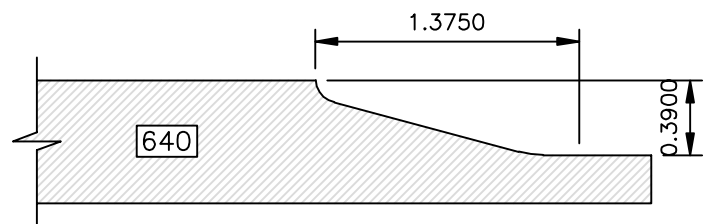
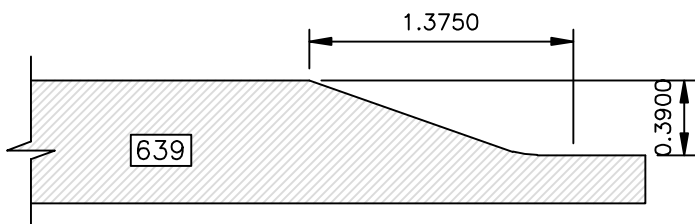
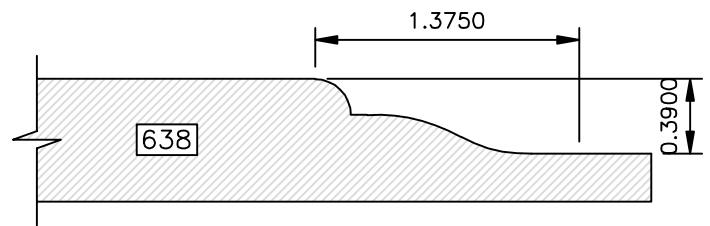
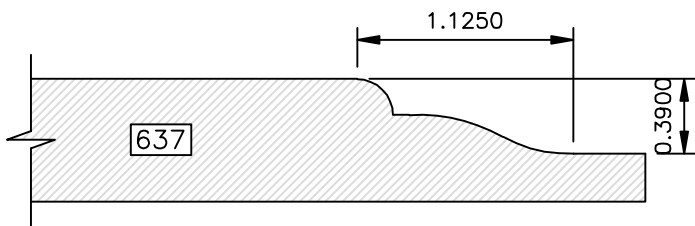
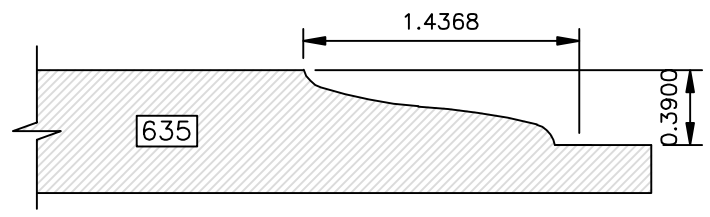
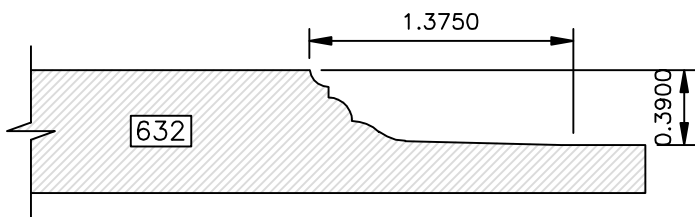
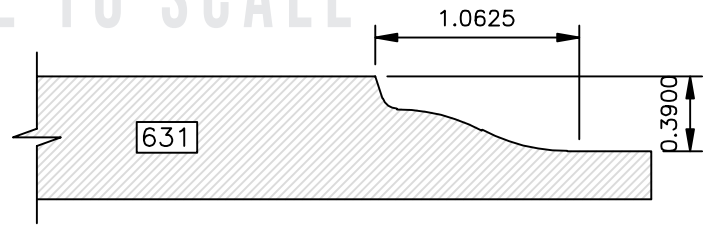
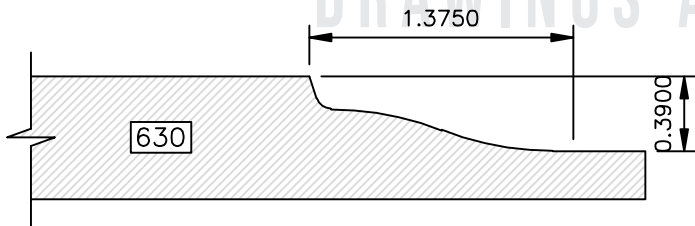
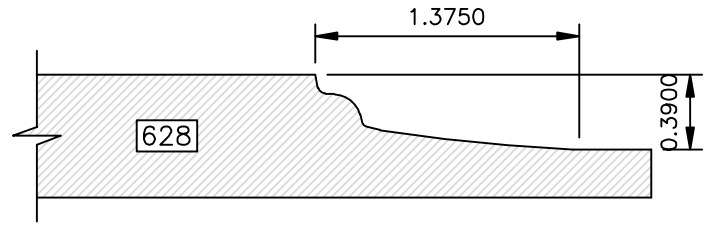
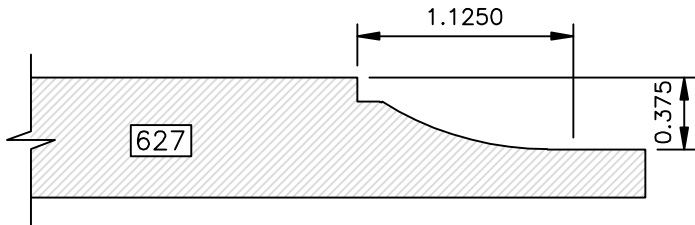
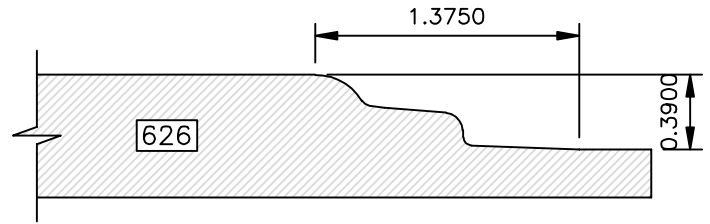
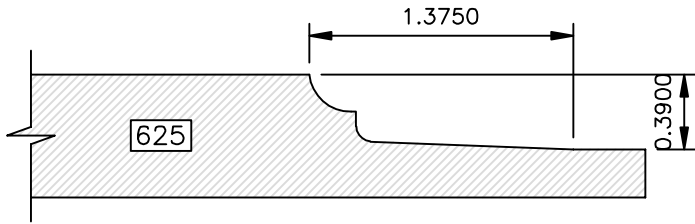

DRAWINGS ARE TO SCALE

Go West!

RAISED PANEL PROFILES

When ordering veneer MDF panel, use 690 as the panel profile.

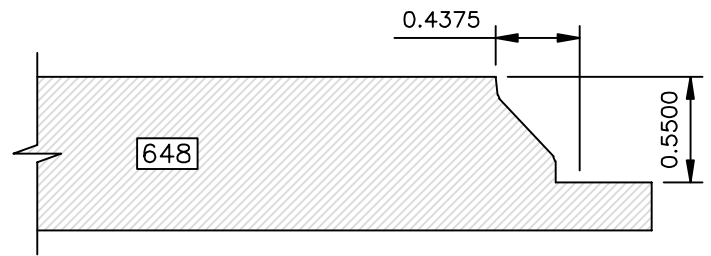
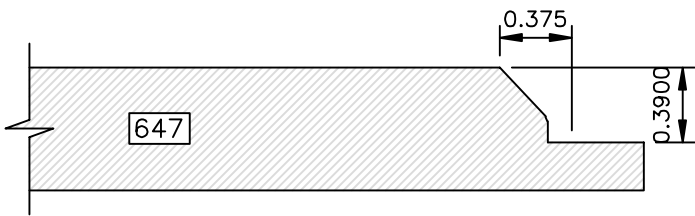
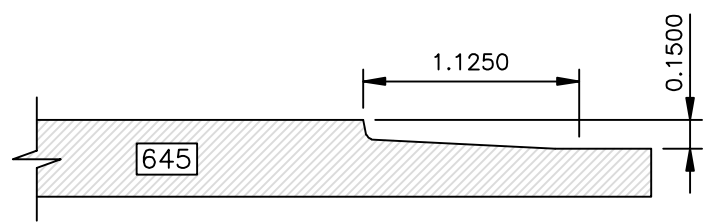
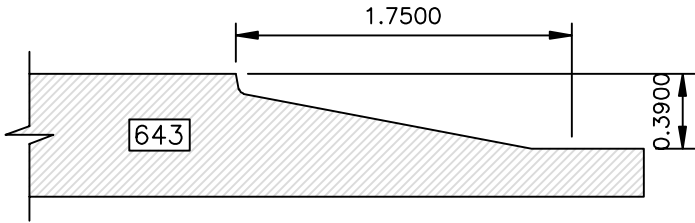
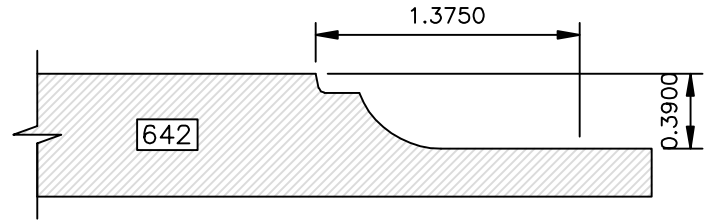
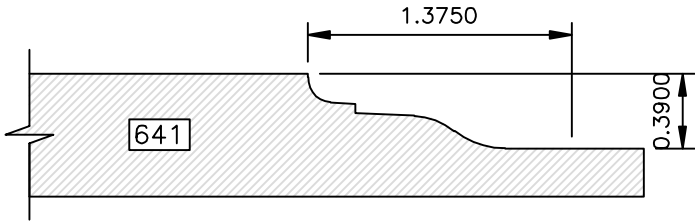

Available in 1" Thick Only

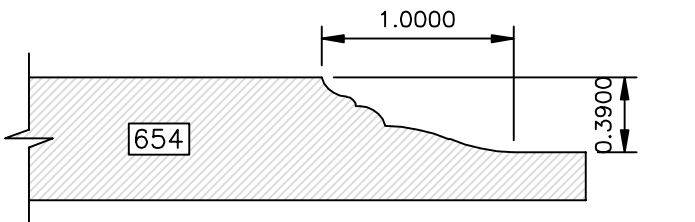
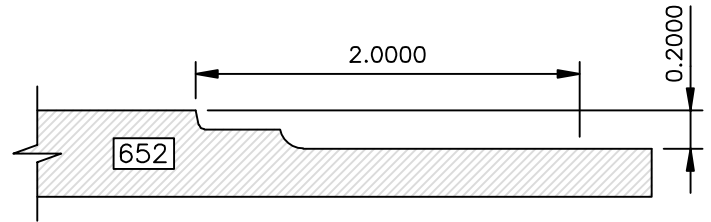
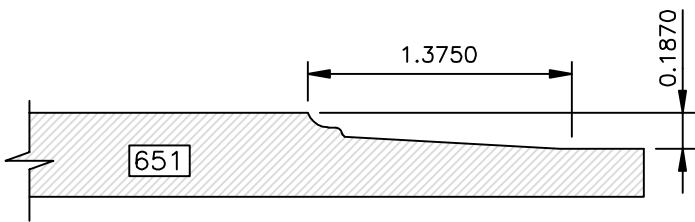
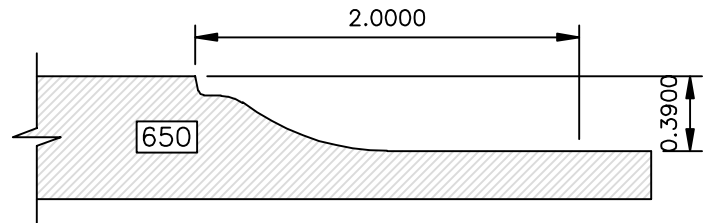
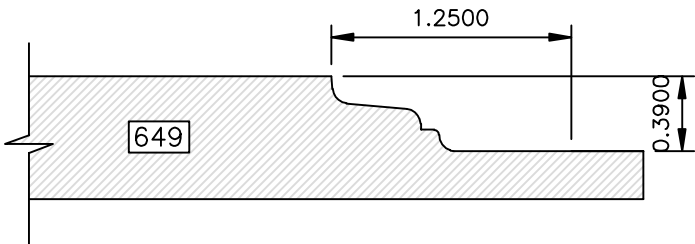

RAISED PANEL PROFILES

Go West!

When ordering veneer MDF panel, use 690 as the panel profile.

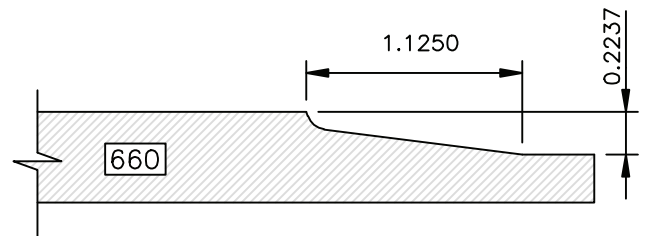
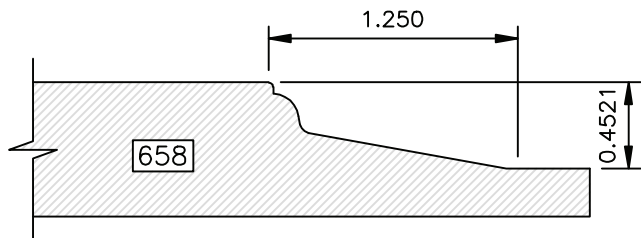
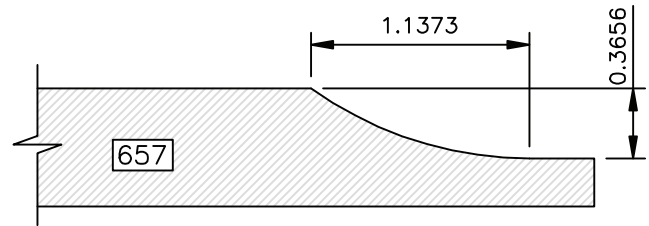
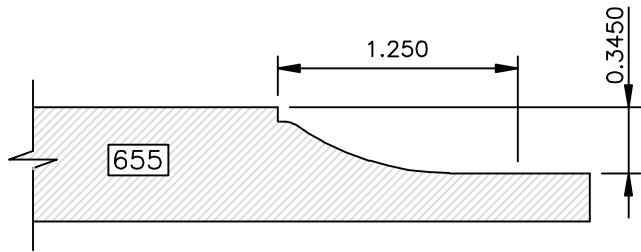

Available in 1" Thick Only

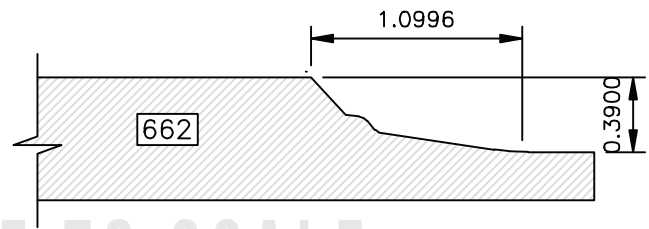
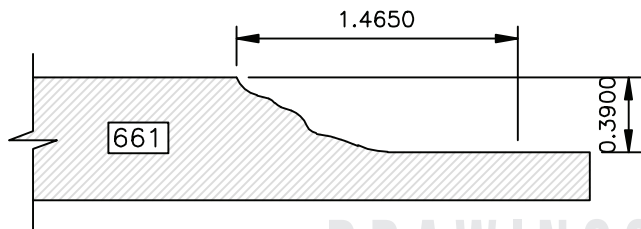

DRAWINGS ARE TO SCALE

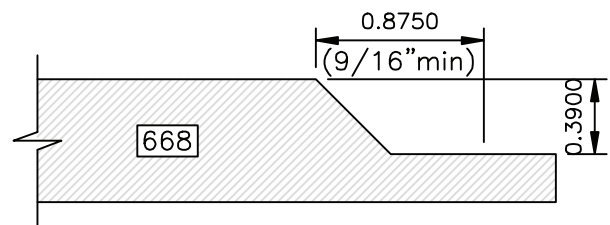
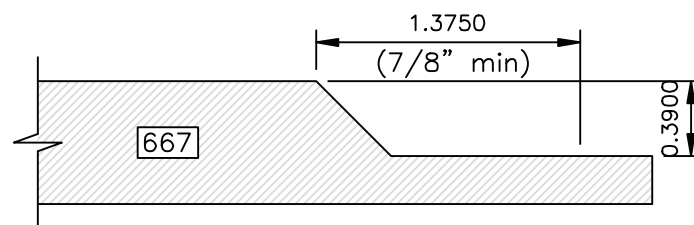
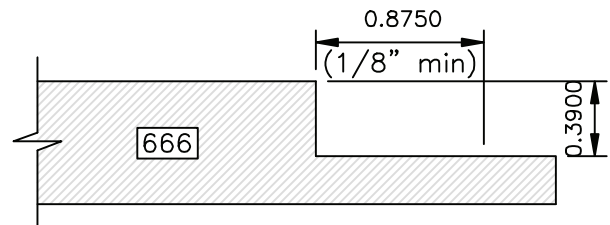
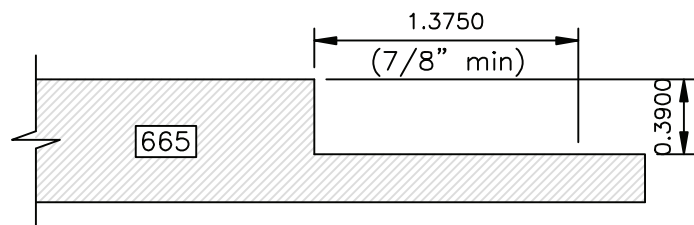
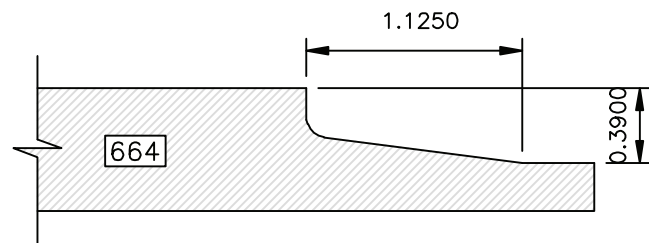
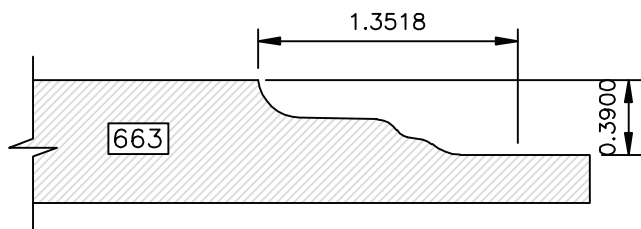

RAISED PANEL PROFILES

When ordering veneer MDF panel, use 690 as the panel profile.

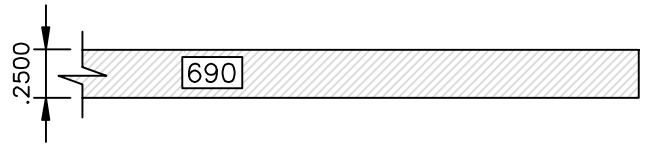
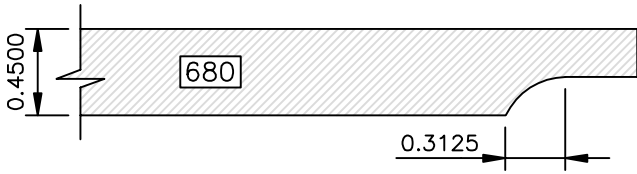

DRAWINGS ARE TO SCALE

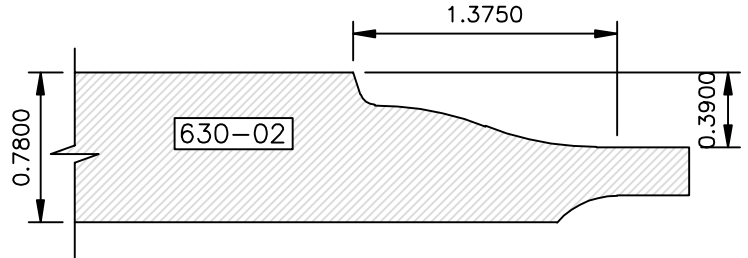
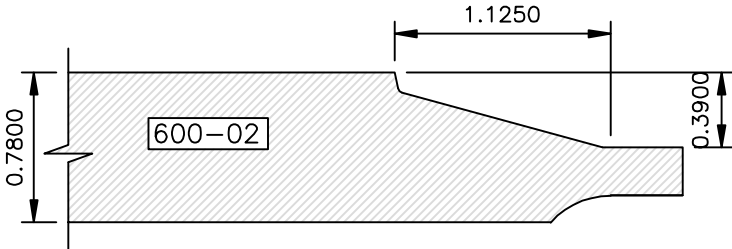

Most of our Panel Profiles are available with an “-02” option. The option adds additional thickness to the back of the panel. Two examples of this are shown above but we did not draw out the option for every available Panel Profile.

BEADED PANEL OPTIONS

Go West!

Spacing (in.)	1	1¼	1½	1¾	2	2¼	2½	2¾	3	3¼	3½	3¾	4	Custom Spacing
---------------	---	----	----	----	---	----	----	----	---	----	----	----	---	----------------

Minimum spacing for beaded panels is 1"

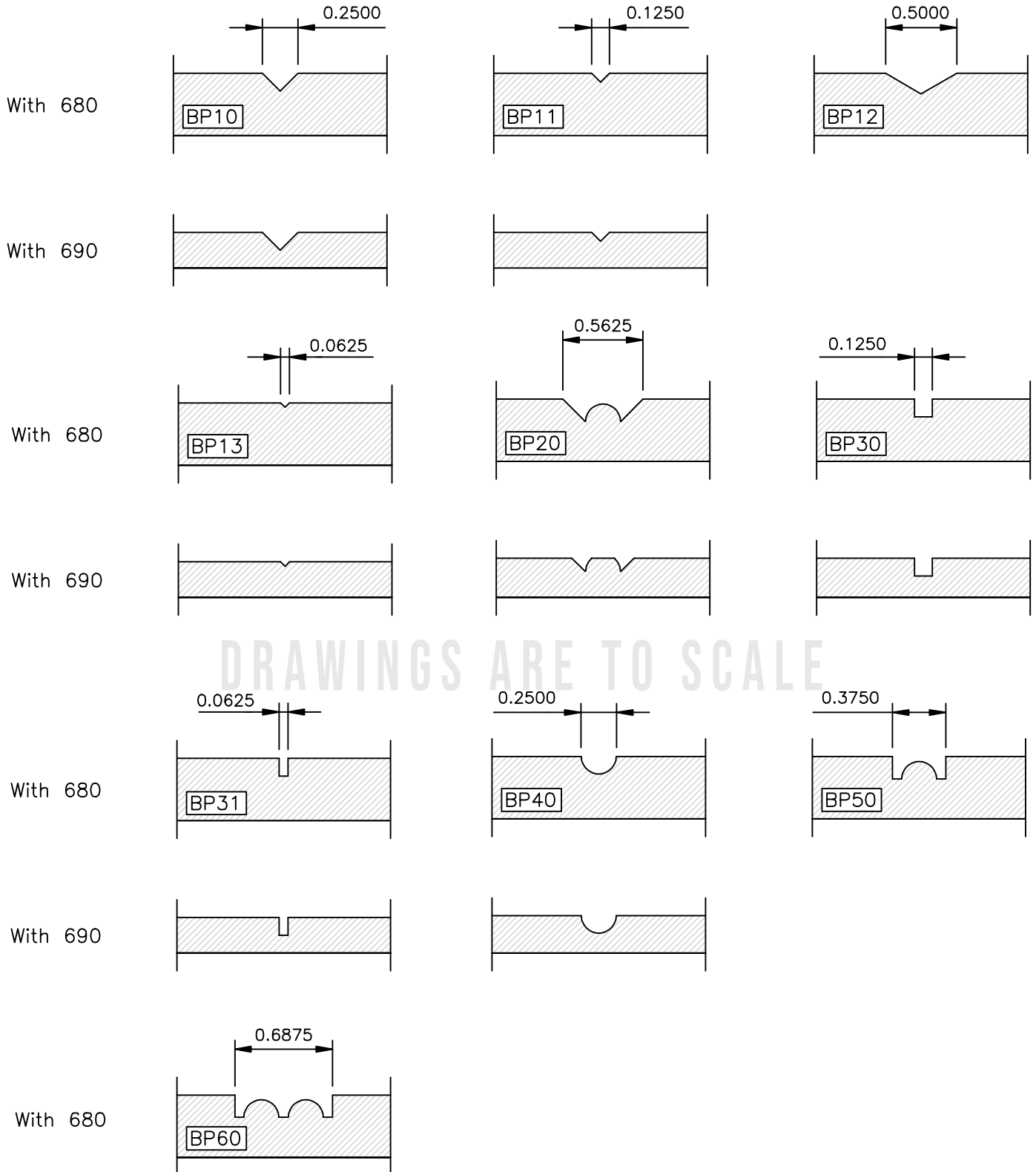

DRAWINGS ARE TO SCALE

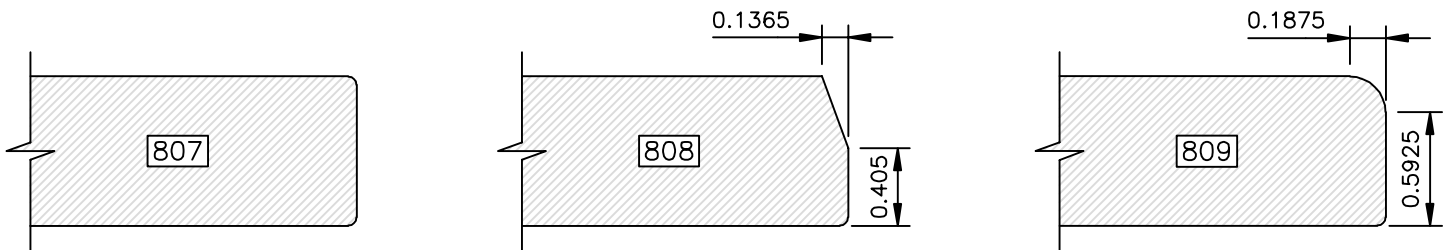
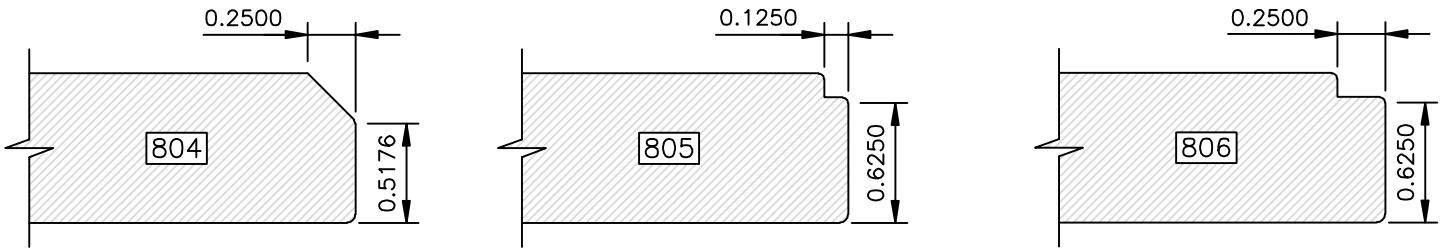
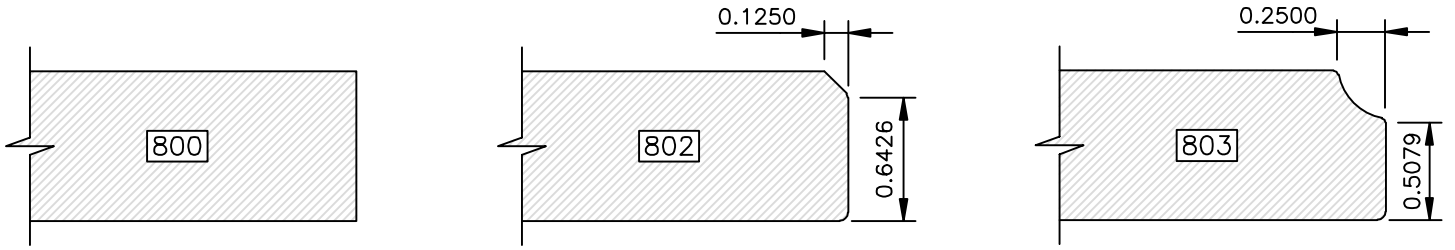

DRAWINGS ARE TO SCALE

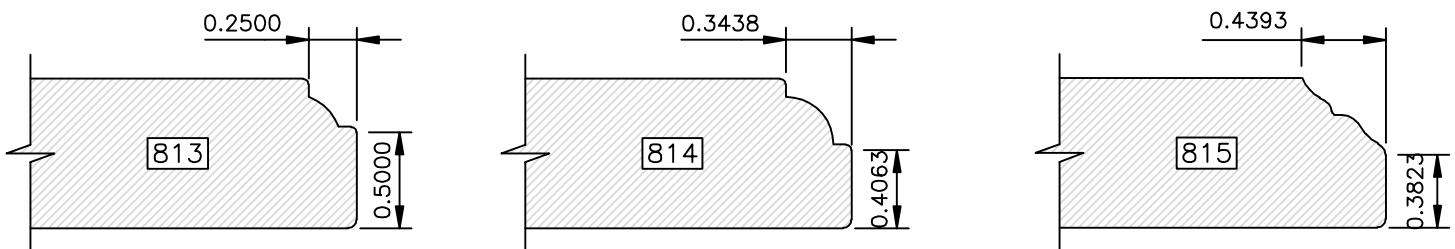
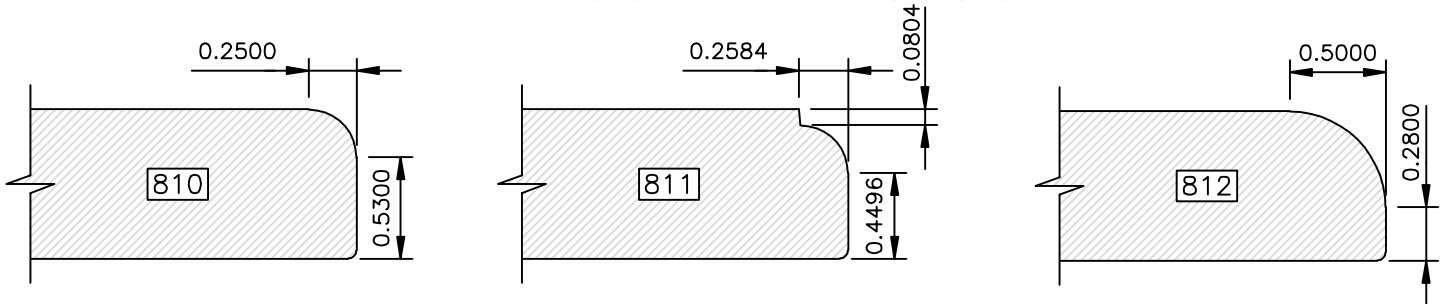

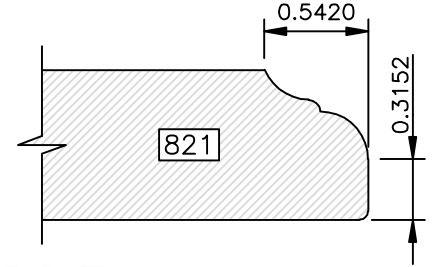
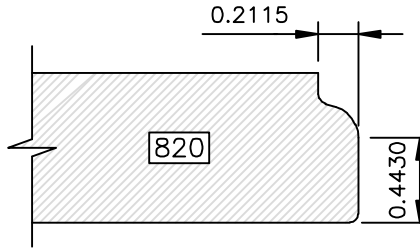
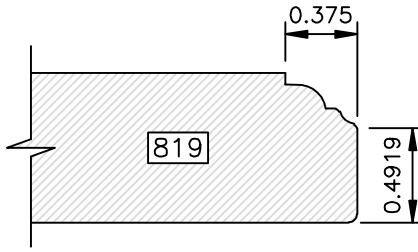
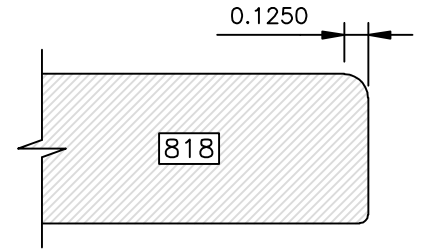
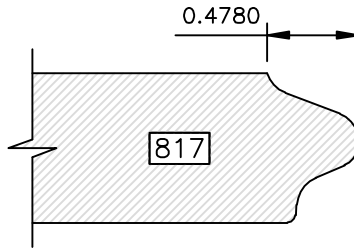
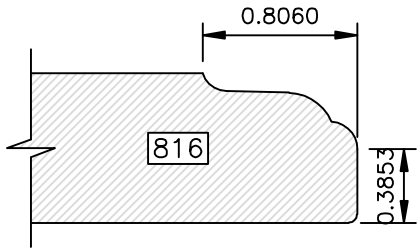

DRAWINGS ARE TO SCALE

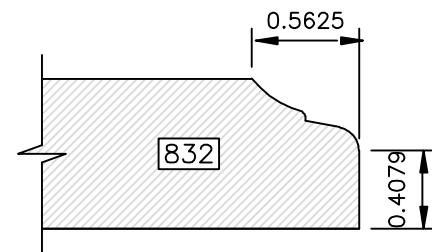
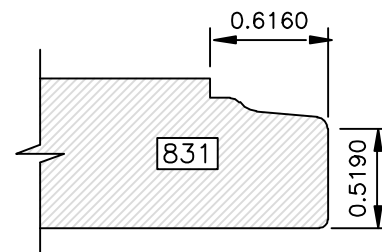
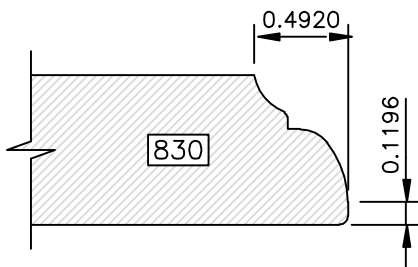
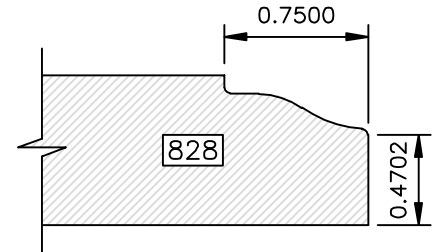
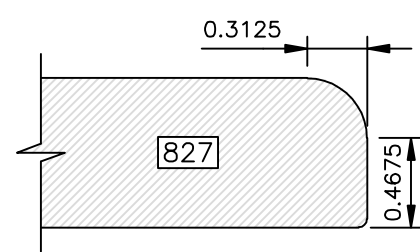
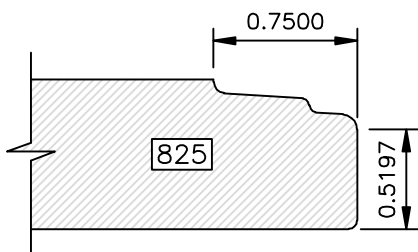
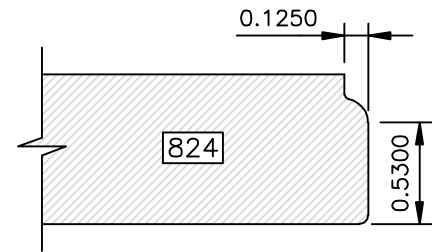
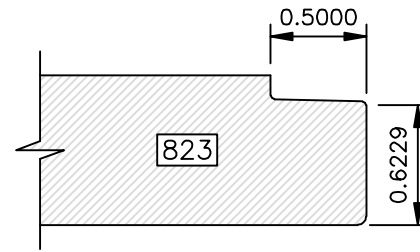
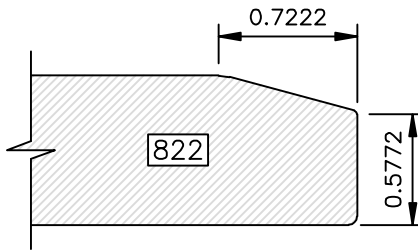

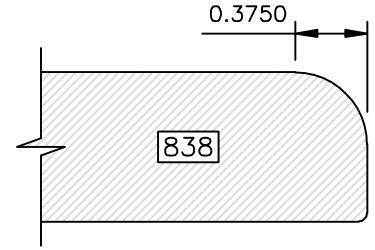
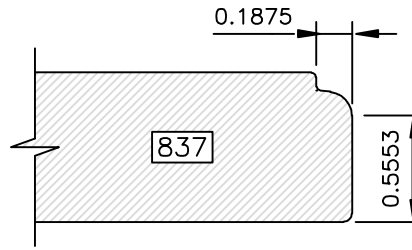
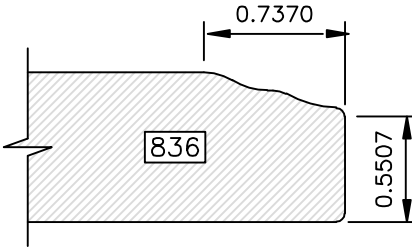
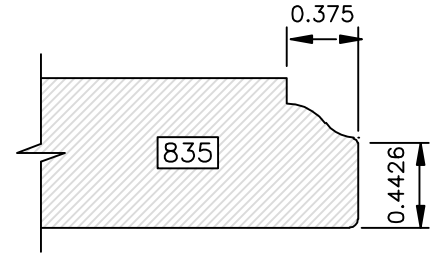
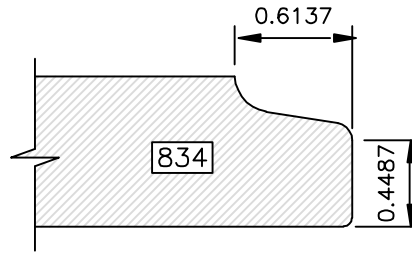
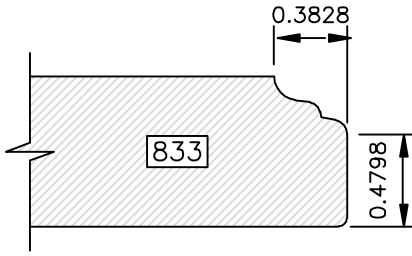

DRAWINGS ARE TO SCALE

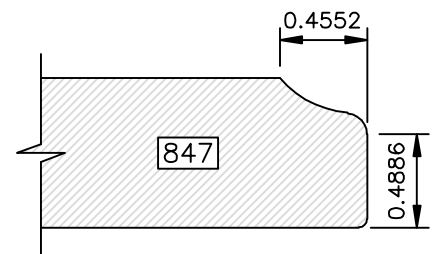
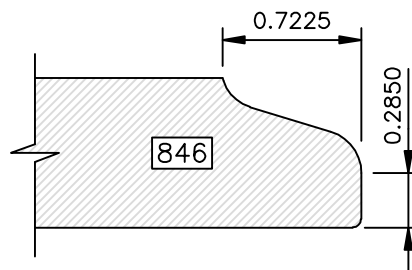
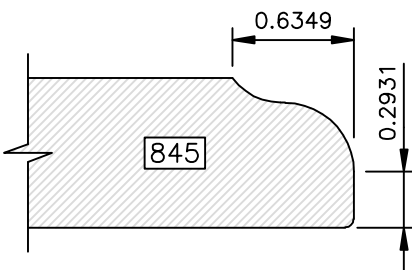
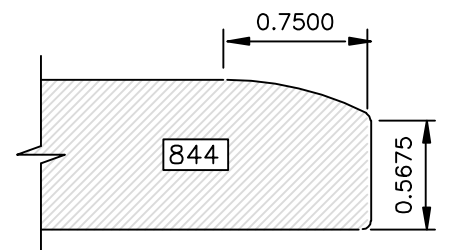
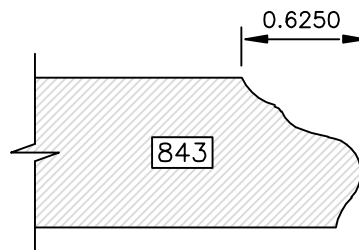
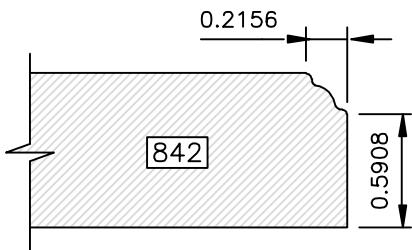
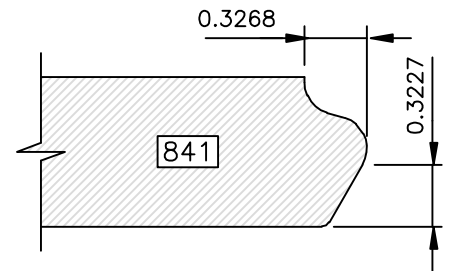
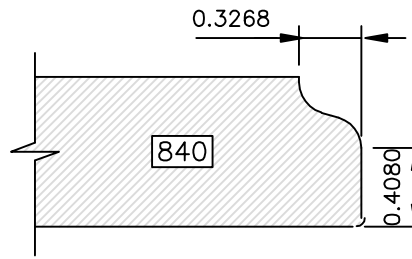
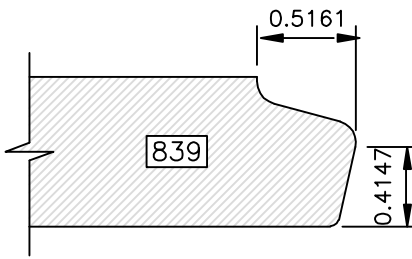

EDGE PROFILES

Go West!

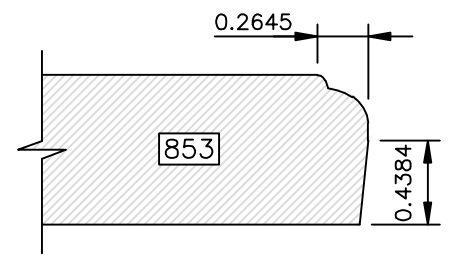
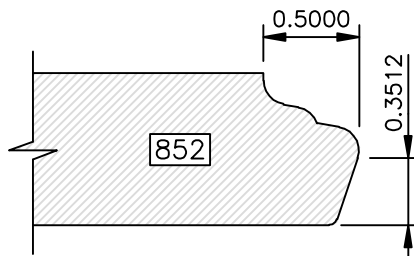
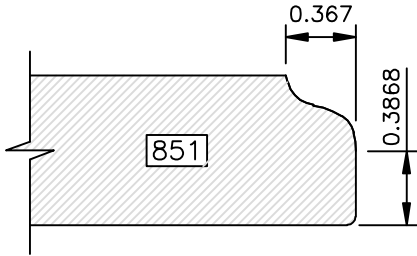
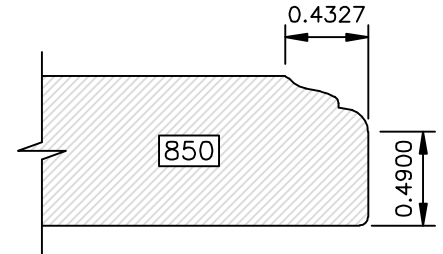
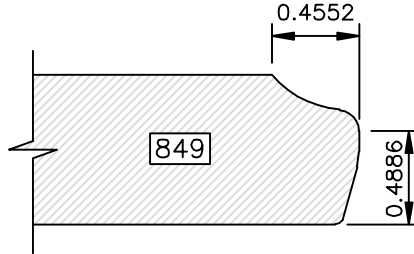
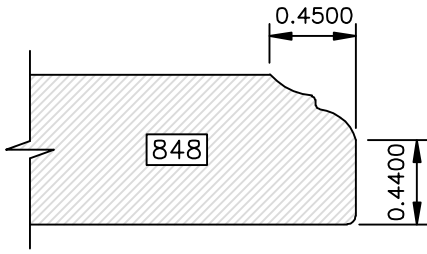

DRAWINGS ARE TO SCALE

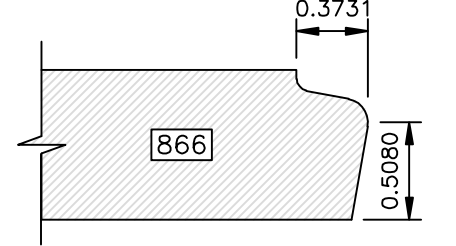
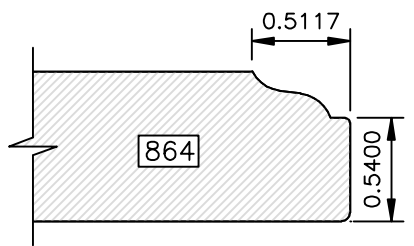
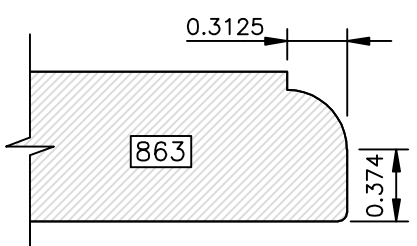
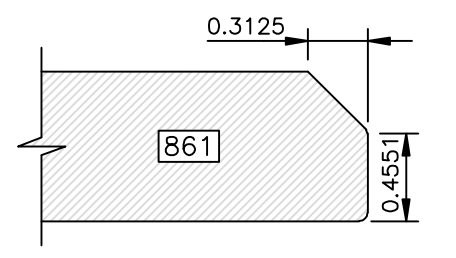
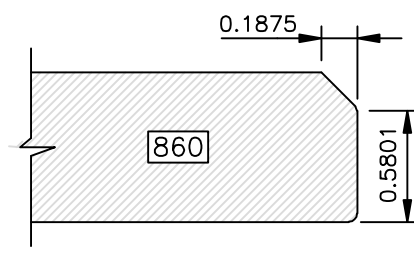
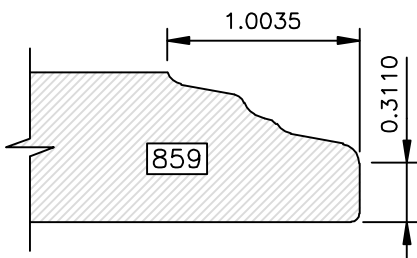
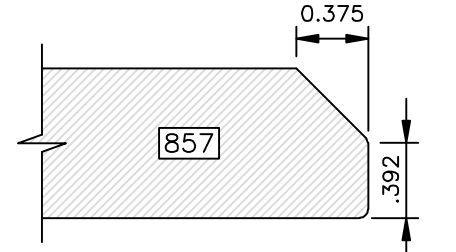
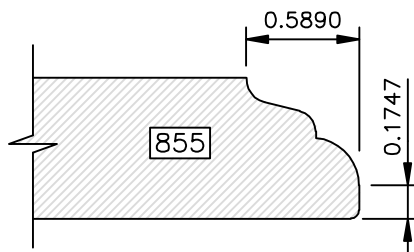
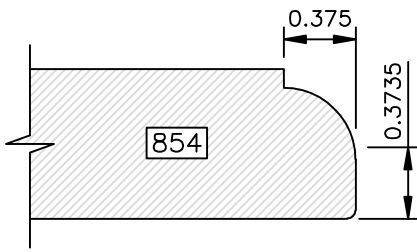

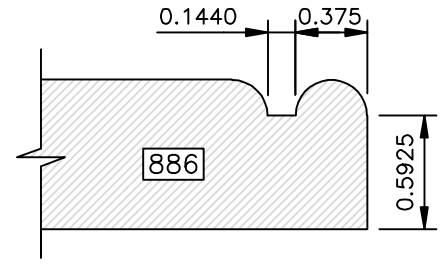
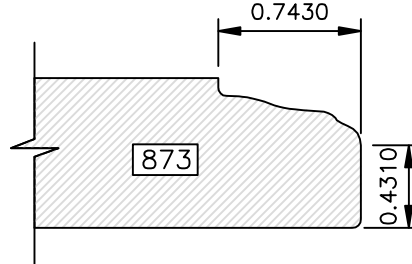
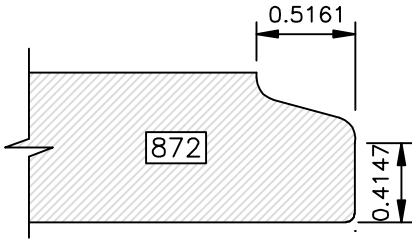
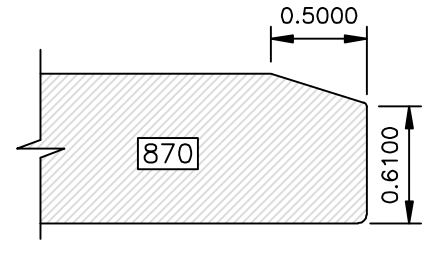
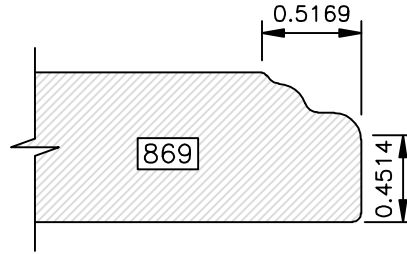
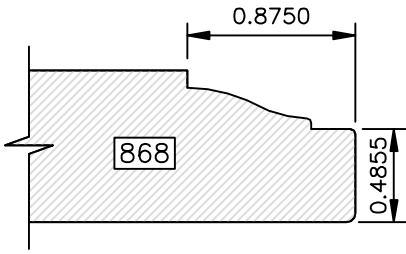

DRAWINGS ARE TO SCALE

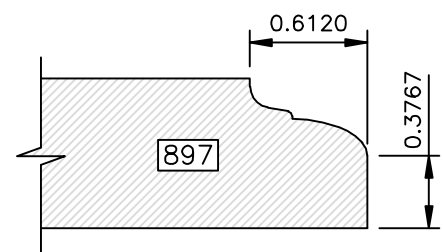
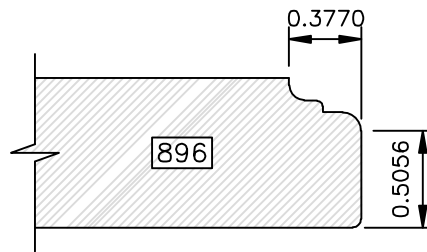
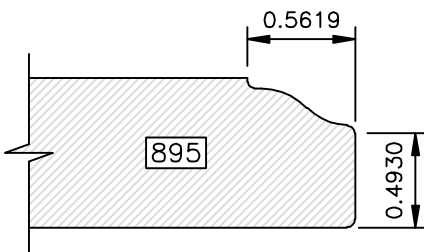
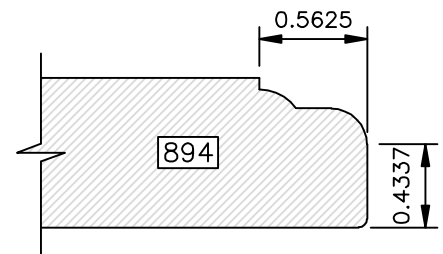
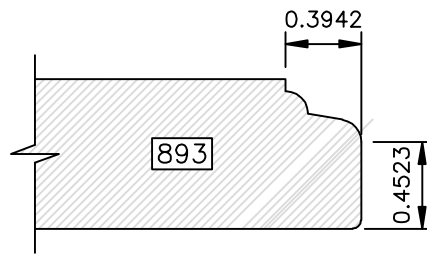
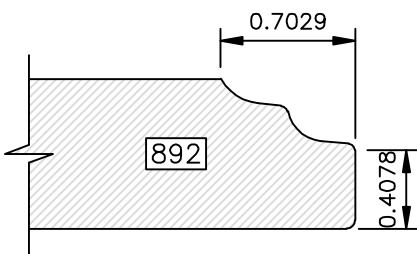
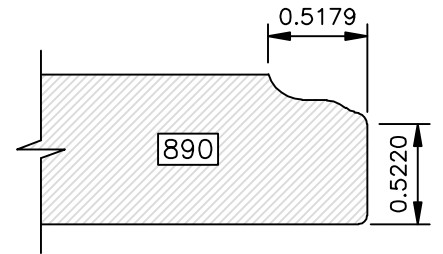
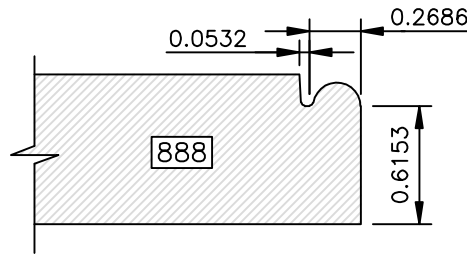
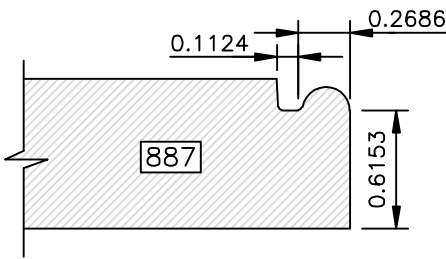

EDGE PROFILES

Go West!

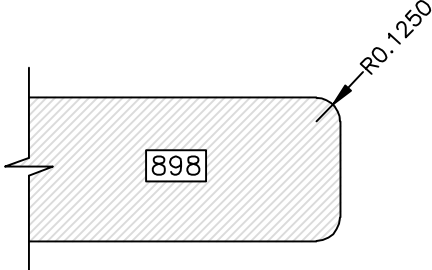

DRAWINGS ARE TO SCALE

Go West!

(8000 SERIES) EDGE PROFILES

Most 8000 series profiles are designed to provide profiles on 441 drawer fronts to match the raised panel profile used in the door. The last three digits of the profile number correspond to the raised panel profile number (i.e. 8641 matches 641). If the last three digits are 800 or higher, there is not a corresponding raised panel profile.

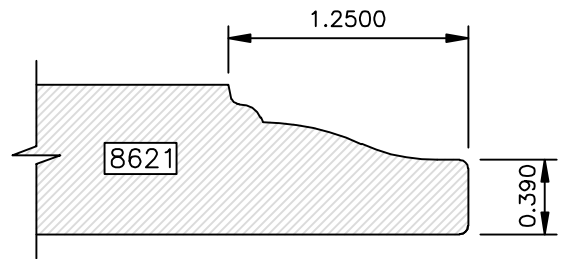
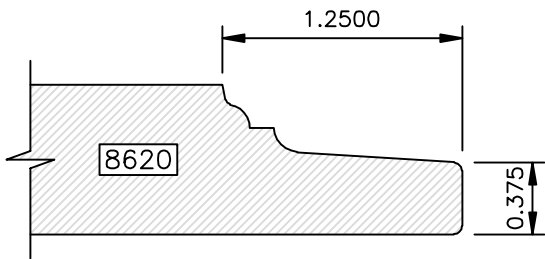
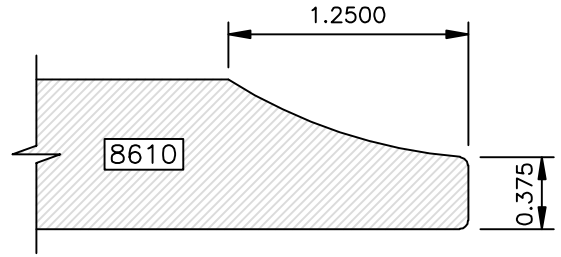
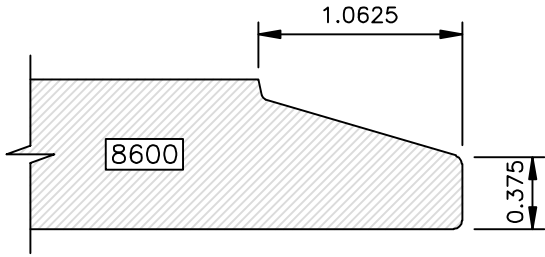

DRAWINGS ARE TO SCALE

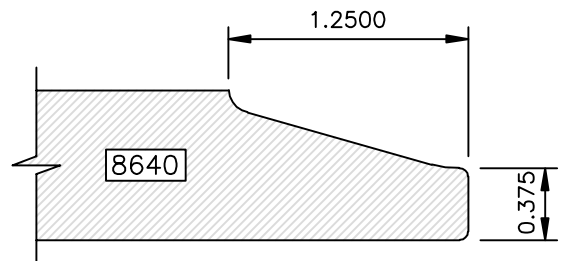
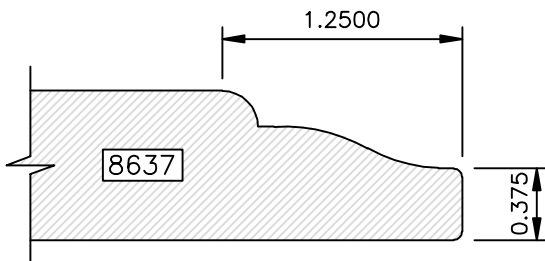
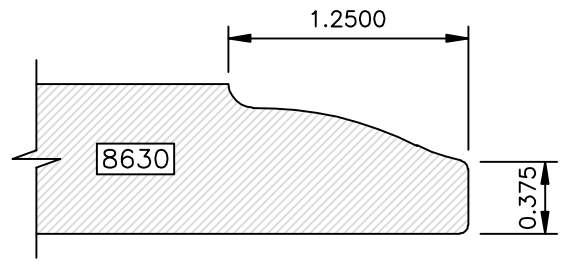
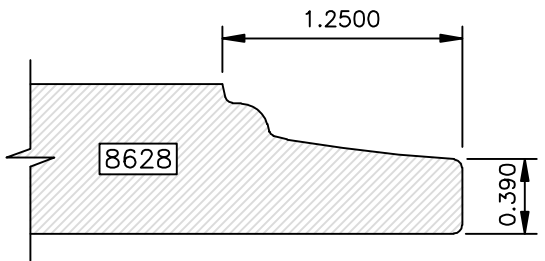

EDGE PROFILES (8000 SERIES)

Go West!

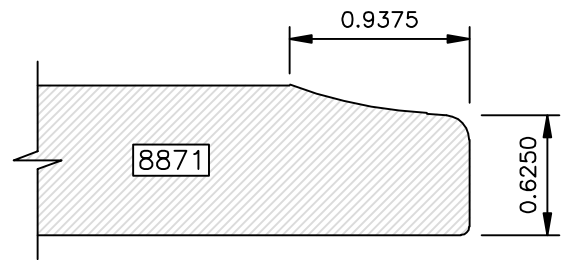
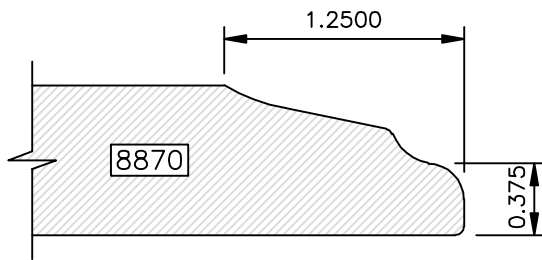
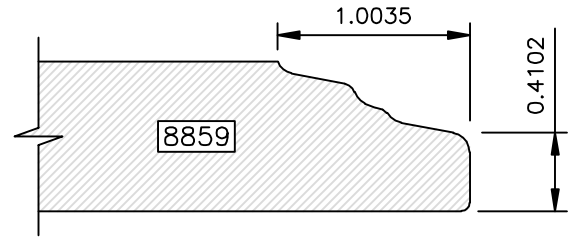
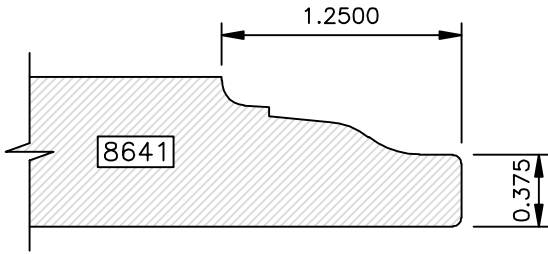

DRAWINGS ARE TO SCALE

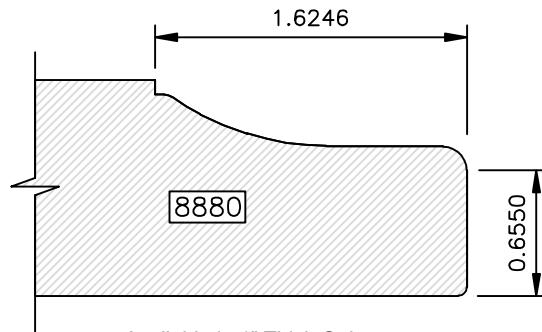
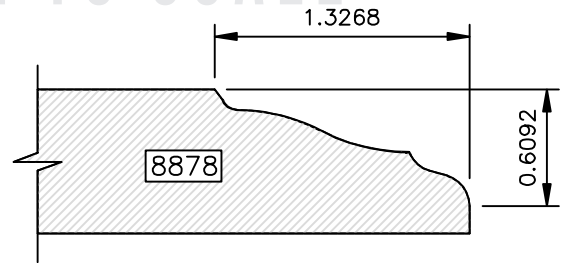
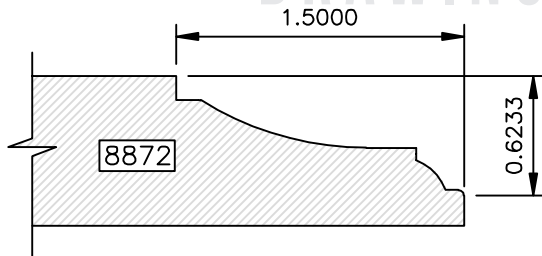

Available in 1" Thick Only

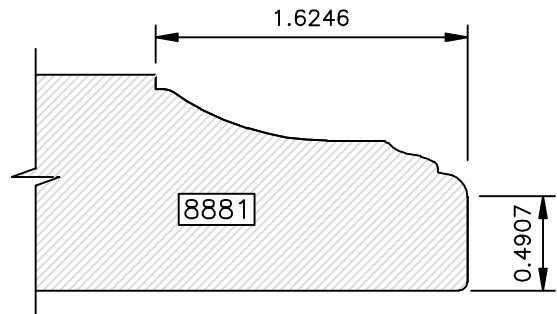

Available in 1" Thick Only

Go West!

(8000 SERIES) EDGE PROFILES

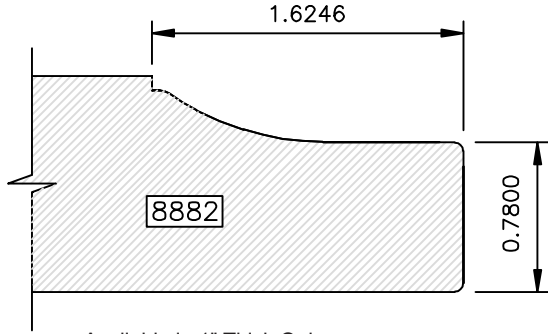

Available in 1" Thick Only

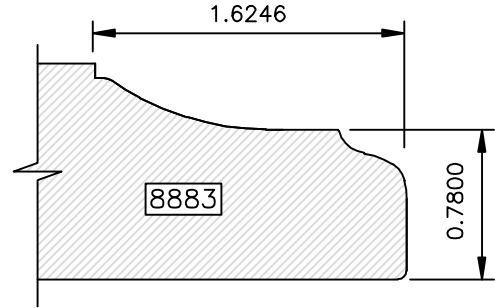

Available in 1" Thick Only

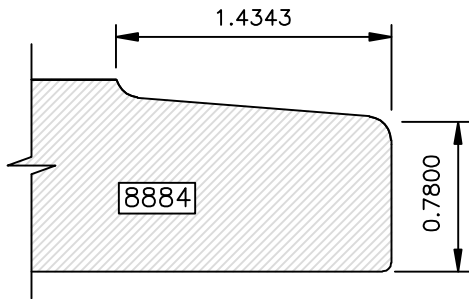

Available in 1" Thick Only

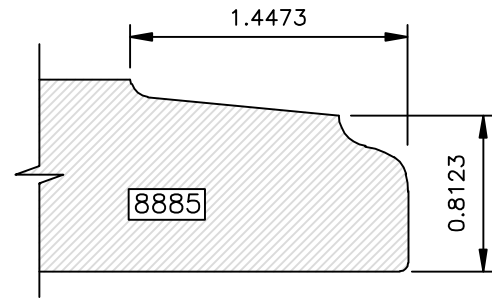

Available in 1" Thick Only

DRAWINGS ARE TO SCALE

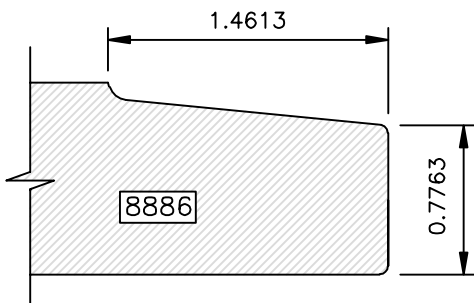

Available in 1" Thick Only

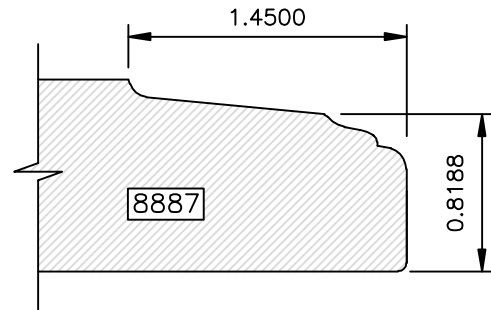

Available in 1" Thick Only

A large grid of graph paper for taking notes, consisting of 20 horizontal rows and 20 vertical columns of small squares.

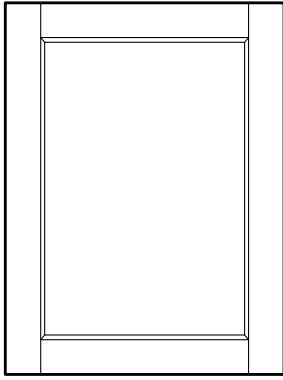

Style 400
Panel Options: **F,R,G**

F = Flat
R = Raised
G = Glass

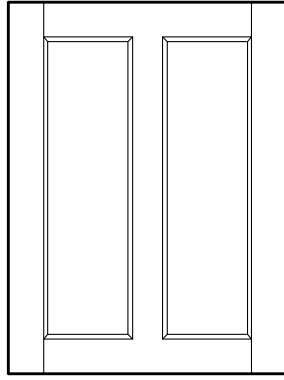

Style 402
Panel Options: **F,R,G**

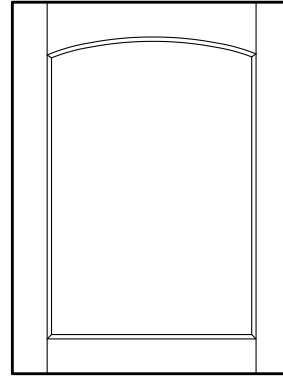

Style 410
Panel Options: **F,R,G**
Arch Rail Width: **3½"**

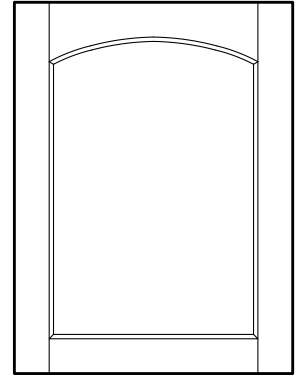

Style 411
Panel Options: **F,R,G**
Arch Rail Width: **4"**

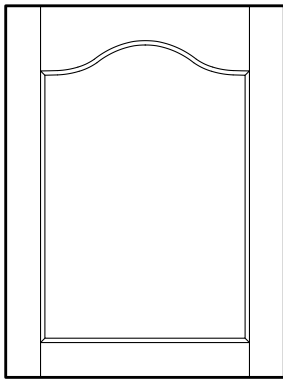

Style 412
Panel Options: **F,R,G**
Arch Rail Width: **4"**

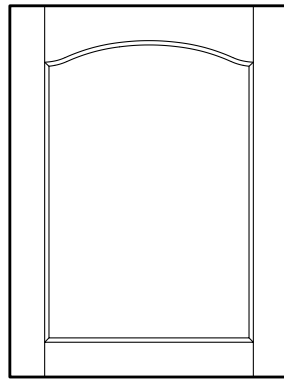

Style 413
Panel Options: **F,R,G**
Arch Rail Width: **3½"**

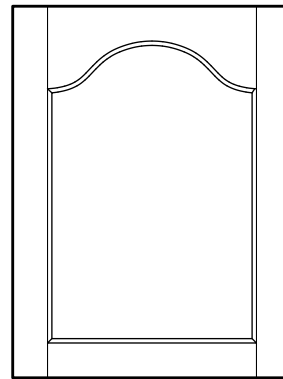

Style 415
Panel Options: **F,R,G**
Arch Rail Width: **5"**

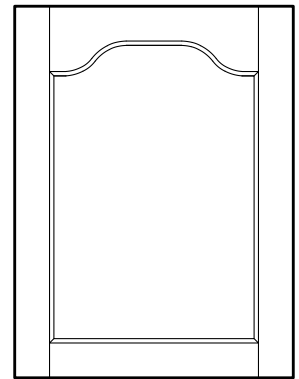

Style 416
Panel Options: **F,R,G**
Arch Rail Width: **4"**

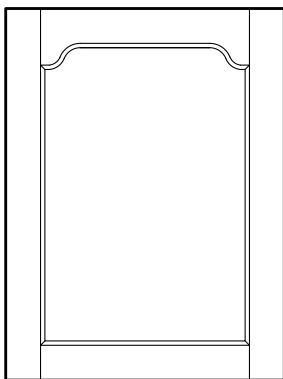

Style 417
Panel Options: **F,R,G**
Arch Rail Width: **3½"**

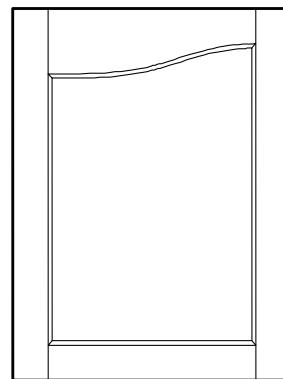

Style 412-HL**
Panel Options: **F,R,G**

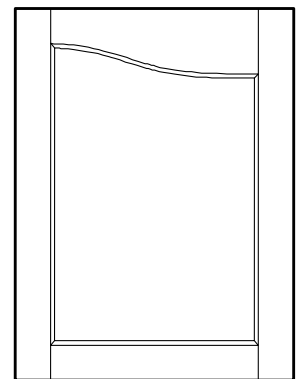

Style 412-HR**
Panel Options: **F,R,G**

**Style 412 shown as sample only. Half-lefts and half-rights are available in all arch styles.

DOUBLE ARCH DOOR STYLES

Go West!

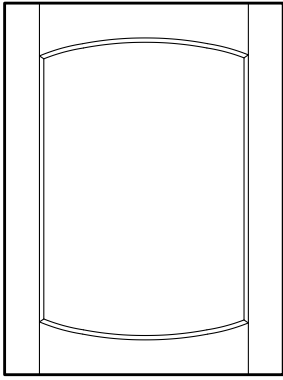

Style 410-D
Panel Options: **F,R,G**
Arch Rail Width: 3½"

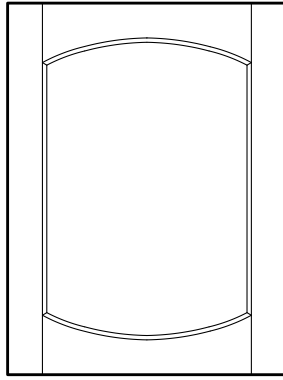

Style 411-D
Panel Options: **F,R,G**
Arch Rail Width: 4"

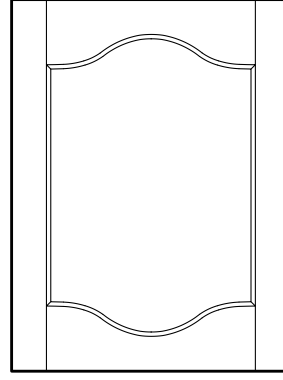

Style 412-D
Panel Options: **F,R,G**
Arch Rail Width: 4"

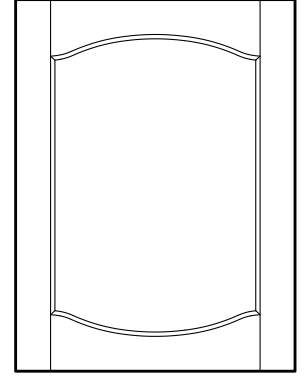

Style 413-D
Panel Options: **F,R,G**
Arch Rail Width: 3½"

F = Flat
R = Raised
G = Glass

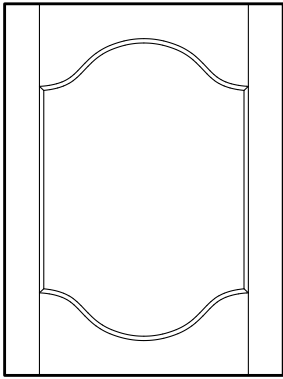

Style 415-D
Panel Options: **F,R,G**
Arch Rail Width: 5"

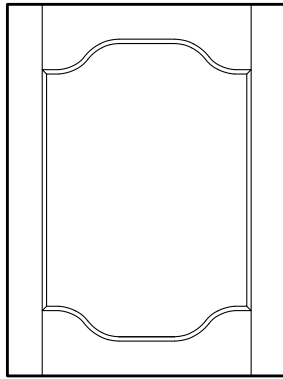

Style 416-D
Panel Options: **F,R,G**
Arch Rail Width: 4"

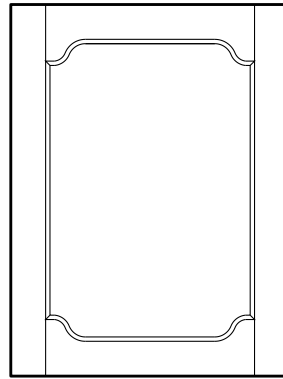

Style 417-D
Panel Options: **F,R,G**
Arch Rail Width: 3½"

Go West!

SOUTHWEST DOOR STYLES

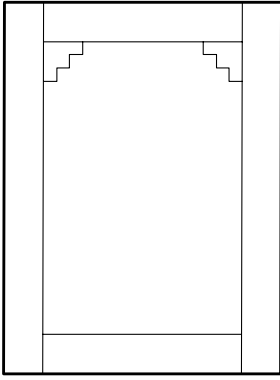

Style 403
Panel Options: F,G

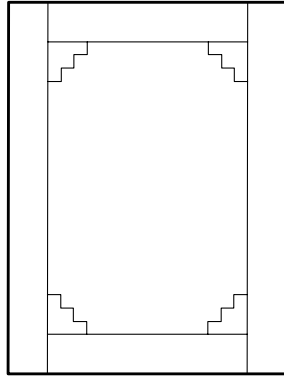

Style 403-D
Panel Options: F,G

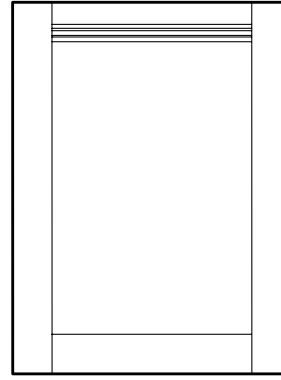

Style 404
Panel Options: F,R,G

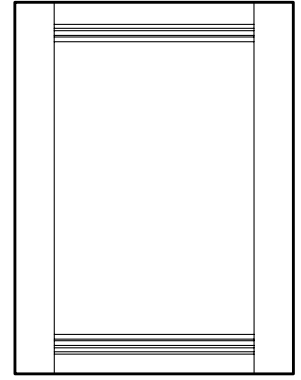

Style 404-D
Panel Options: F,R,G

F = Flat
R = Raised
G = Glass

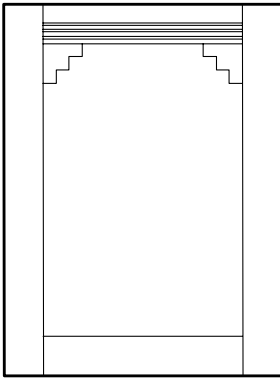

Style 408
Panel Options: F,G

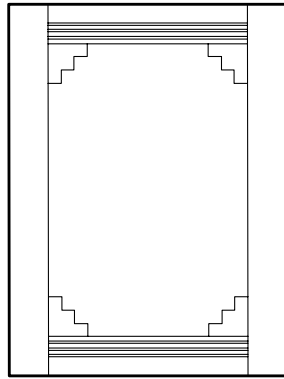

Style 408-D
Panel Options: F,G

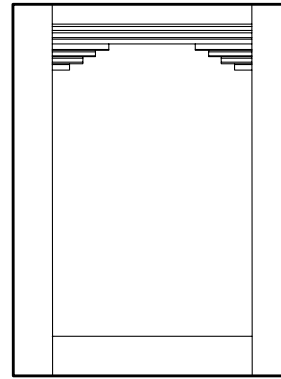

Style 409
Panel Options: F,G

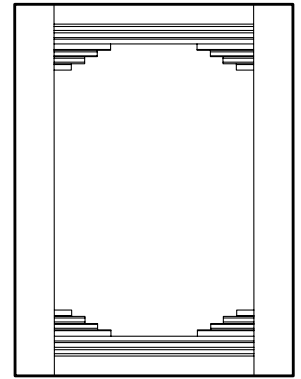

Style 409-D
Panel Options: F,G

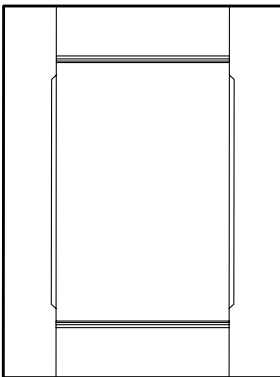

Style 405*
Panel Options: F,R,G
*Style 405 shown
w/ 2.5" stiles and 3" rails
standard.
*Note: 701d only on stiles.

This is a small collection of custom projects done by Westwind. If valance panels, appliance covers, a totally unique door style or any other type of custom work is needed, don't hesitate to talk to someone from our Customer Care Team. Westwind can accommodate almost any project.

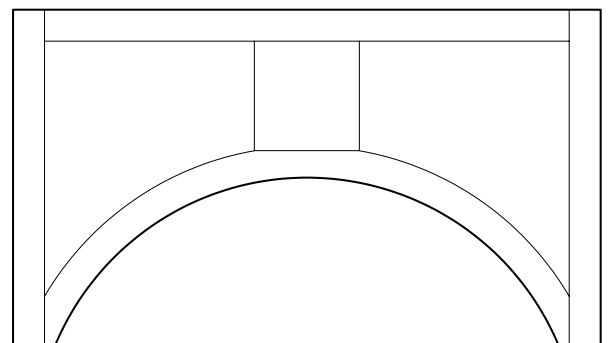
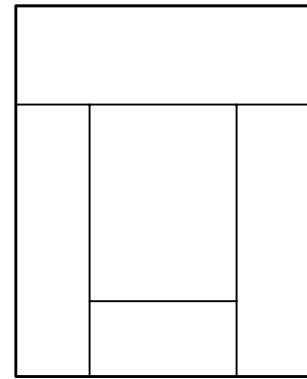
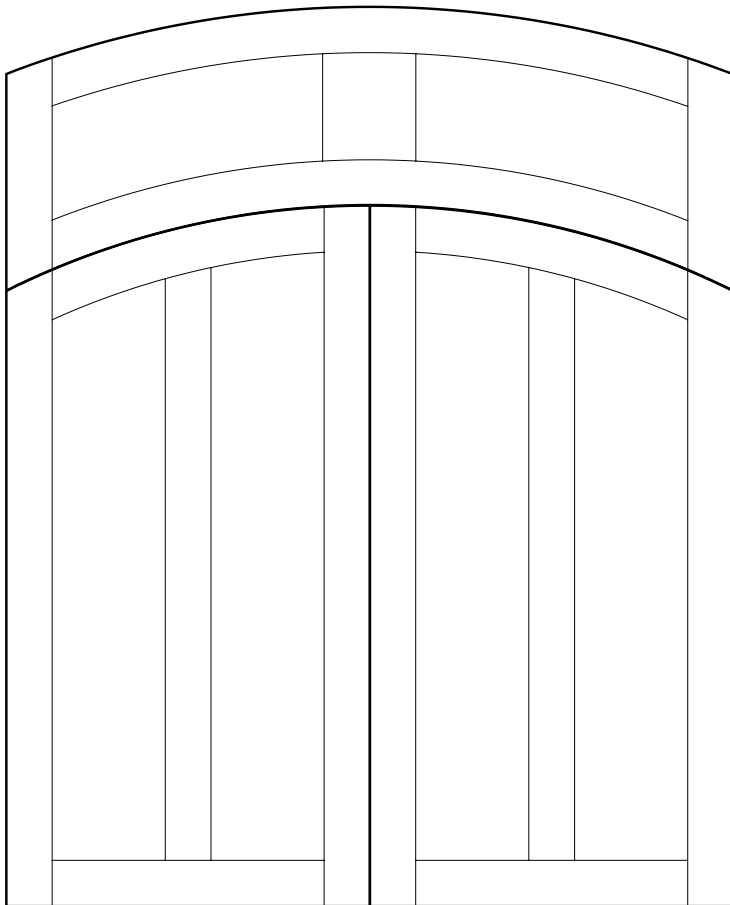
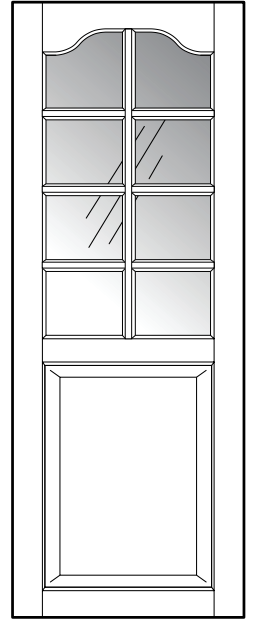
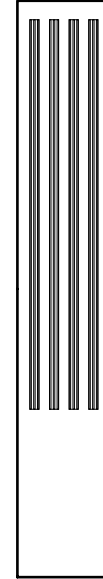
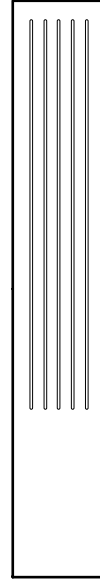
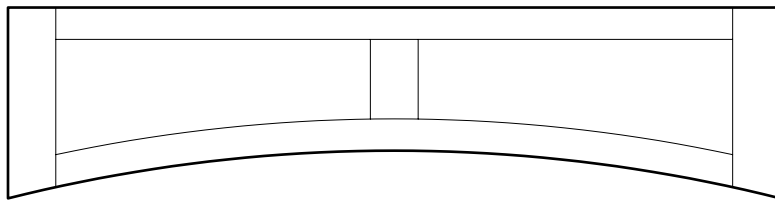
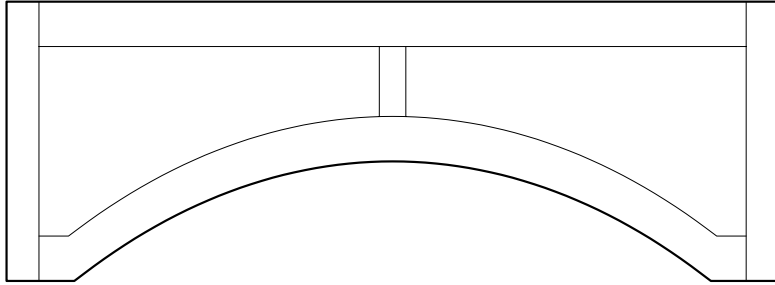

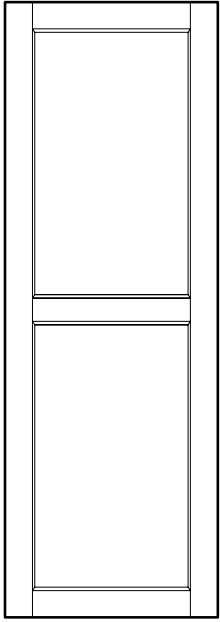

Style 400-2
50/50 Split
Panel Options: **F,R,G**

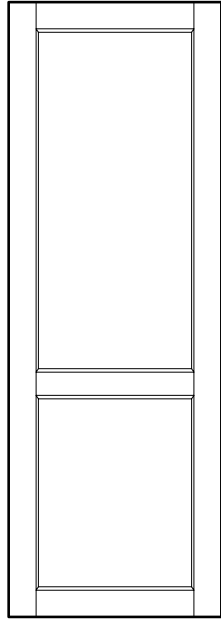

Style 400-3
Custom Split
Panel Options: **F,R,G**

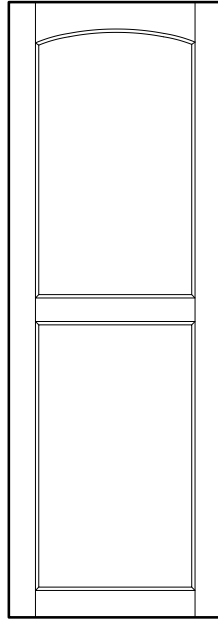

Style 410-2
Custom Split
Panel Options: **F,R,G**
Arch Rail Width: 3½"

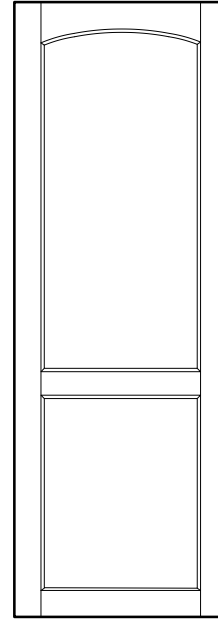

Style 410-3
Custom Split
Panel Options: **F,R,G**
Arch Rail Width: 3½"

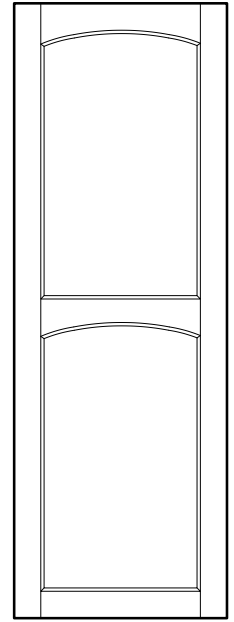

Style 410-4
50/50 Split
Panel Options: **F,R,G**
Arch Rail Width: 3½"

F = Flat
R = Raised
G = Glass

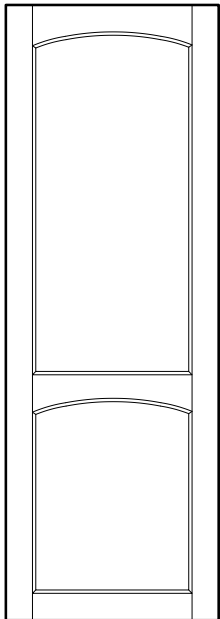

Style 410-5
Custom Split
Panel Options: **F,R,G**
Arch Rail Width: 3½"

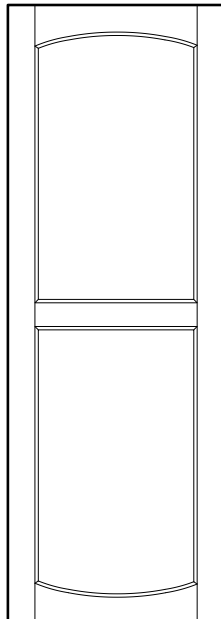

Style 410-D-2
50/50 Split
Panel Options: **F,R,G**
Arch Rail Width: 3½"

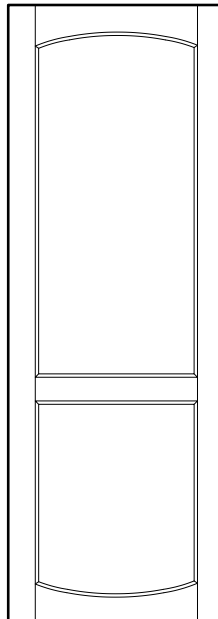

Style 410-D-3
Custom Split
Panel Options: **F,R,G**
Arch Rail Width: 3½"

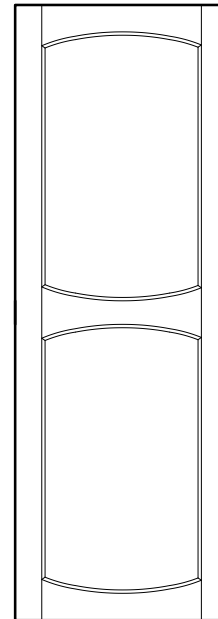

Style 410-D-8
Custom Split
Panel Options: **F,R,G**
Arch Rail Width: 3½"

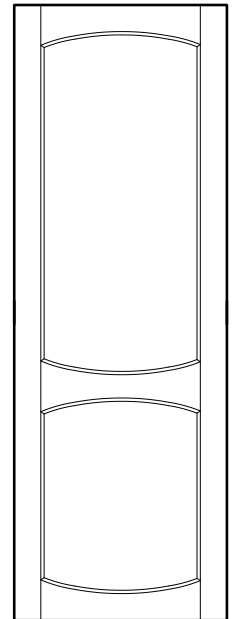

Style 410-D-9
Custom Split
Panel Options: **F,R,G**
Arch Rail Width: 3½"

Door Style	Description
400-2	Midrail Equal Spacing
400-3	Midrail Custom Spacing
410, 411, 412, 413, 414, 415, 416, 417 “-2”	Square Midrail Equal Spacing
410, 411, 412, 413, 414, 415, 416, 417 “-3”	Square Midrail Custom Spacing
410, 411, 412, 413, 414, 415, 416, 417 “-4”	Arched Midrail Equal Spacing
410, 411, 412, 413, 414, 415, 416, 417 “-5”	Arched Midrail Custom Spacing
410, 411, 412, 413, 414, 415, 416, 417 “-D-2”	Square Midrail Equal Spacing
410, 411, 412, 413, 414, 415, 416, 417 “-D-3”	Square Midrail Custom Spacing
410, 411, 412, 413, 414, 415, 416, 417 “-D-8”	Double Arched Midrail Equal Spacing
410, 411, 412, 413, 414, 415, 416, 417 “-D-9”	Double Arched Custom Spacing

For Double Tall doors, please use the above chart and the example pictures shown on the previous page to help determine the correct number of Upgrade Units for the chosen Double Tall door selection. Most door styles are available in Double Tall configurations. To avoid confusion we have chosen to use the 400 and 410 door styles to display all of the variations possible with Double Tall door styles. If a Double Tall door is required in a style other than 400 or 410, please indicate this on the order form. Available door styles are shown on page 39. **For Double Tall door styles with custom mid rail placement, please specify the dimension from the top of the door to the top of the mid rail.**

Double Tall doors with a size greater than 36"x96" will receive wainscoting pricing outlined on page 45.

Westwind offers frame only doors (with or without mullions) in all door styles. The drawings below are examples of mullion configurations commonly used. If a custom mullion placement is required, please provide a drawing with the order.

Westwind offers three different options for prepping Frame Only Doors for glass. FOXP molding is a clear plastic molding that provides a simple option for inserting the glass into the frame. FOXP molding fits into a slot prepped for 1/8" glass. Wood Stop is a small molding/trim piece that we can provide, and you can cut to the necessary lengths and fasten to the door frame to retain the glass. We can also simply Rout the frame and you can take care of the attachment method on your own.

Rout Only

Wood Stop

FOXP

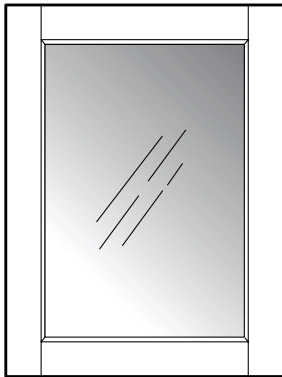

Style 400-0L
Panel Options: **G**

G = Glass

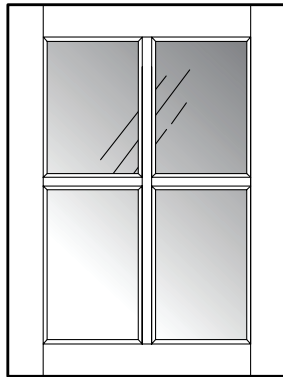

Style 400-4L
Panel Options: **G**

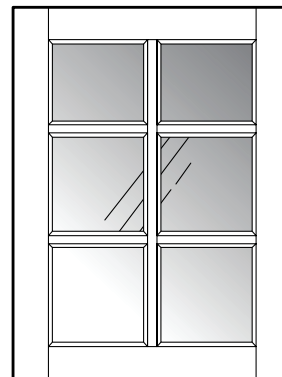

Style 400-6L
Panel Options: **G**

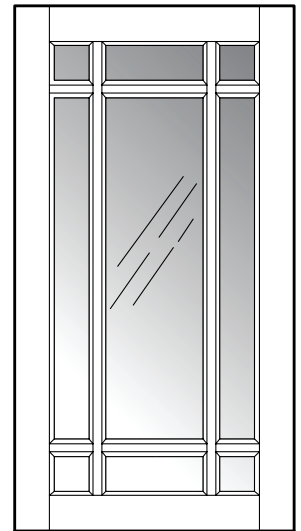

Style 400-9L*
"Prairie Style"
Panel Options: **G**

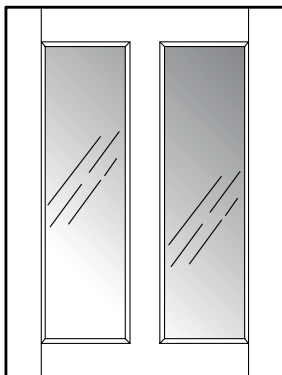

Style 402-0L
Panel Options: **G**

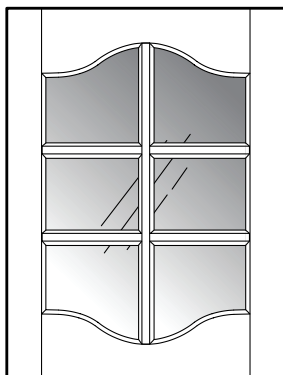

Style 412-D-6L
Panel Options: **G**

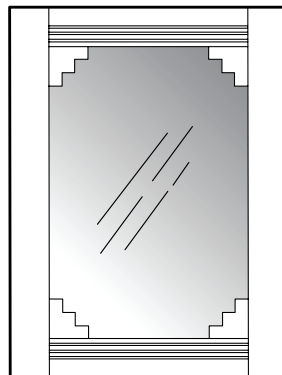

Style 408-D-0L
Panel Options: **G**

* Standard corner lite size for Prairie Style is 2". To receive this treatment, note it on the order form. Orders without notation will be made as equal size lites. Prairie Style is available only in 400 series door.

FRAME ONLY STYLES

Go West!

Number Lites	Description
2	Lite Vertical Mullion
4	Lite Standard Spacing
6	Lite Standard Spacing
9	Lite 'Prairie'
2	Lite Custom Mullion
4	Lite Custom Spacing
6	Lite Custom Spacing
9	Lite Custom Spacing
2	*True Lite Vertical Mullion
4	*True Lite Standard Spacing
6	*True Lite Standard Spacing
9	*True Lite 'Prairie'

* True Lite means a piece of glass per lite instead of one single piece of glass for all lites.

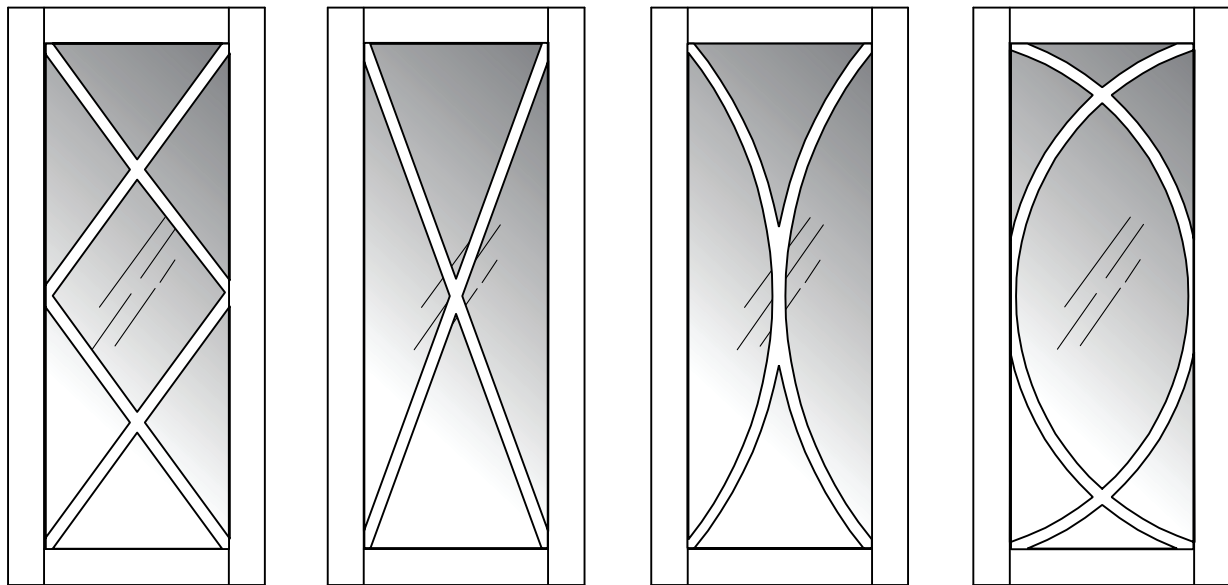

Multiple Piece Drawer Fronts

Standard 401 drawer fronts include reduced rails and horizontal grain on the panel. If vertical grain is desired, please check the appropriate box on the door order form. **When ordering 401 drawer fronts with raised panels, please consider drawer front height and panel raise reveal to determine rail width and if the raised panel choice is even feasible.**

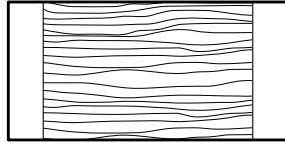

Style 401-3

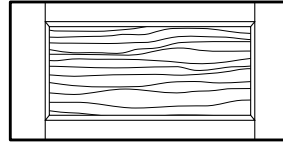

Style 401
Panel Options: F,R,G
1½" Rail Standard

F = Flat
R = Raised
G = Glass

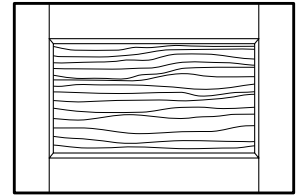

Style 400*
Panel Options: F,R,G
*Style 400 shows
regular size rail width
w/ horizontal grain.

Slab Style Drawer Fronts

Slab style drawer fronts can match the door edge profile or the door panel profile, but the choices are not limited to exact matches. When the edge profile is matched, the drawer edge will be the same thickness as the doors; and when the panel profile is matched, the drawer edge will be thinner than the doors (see notes for 8000 series on pages 31-33).



Style 441
Panel Options: Slab Only
Grain Direction: Horizontal



Match Door Edge

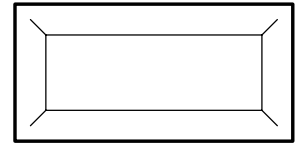

Match Door Panel

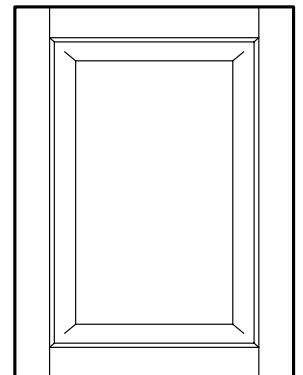
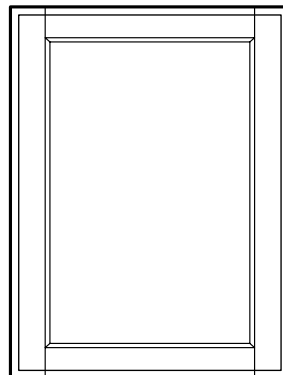

A large grid of graph paper for taking notes, consisting of 20 horizontal rows and 20 vertical columns of small squares.

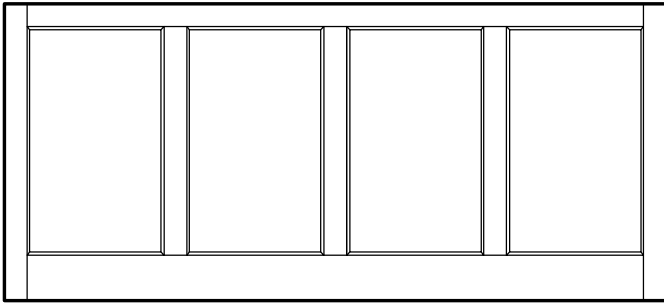

Style **400-WS**
Panel Options: **F,R,G**

F = Flat
R = Raised
G = Glass

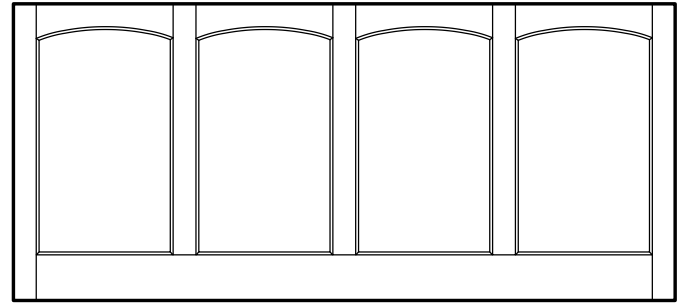

Style **410-WS**
Panel Options: **F,R,G**

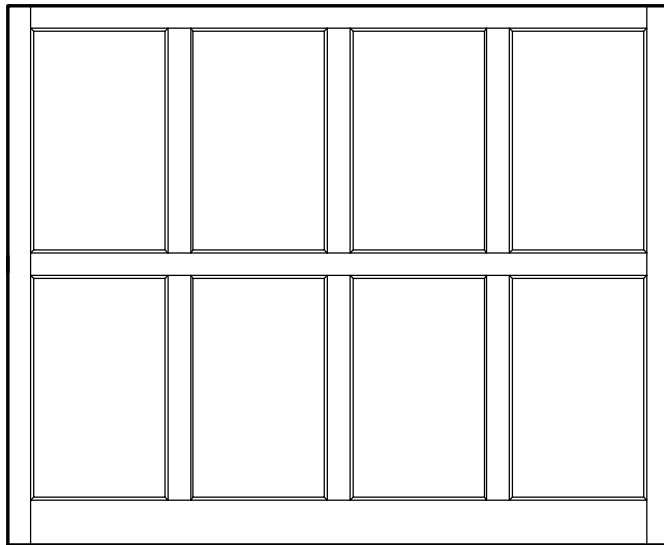

Style **400-2-WS**
Panel Options: **F,R,G**

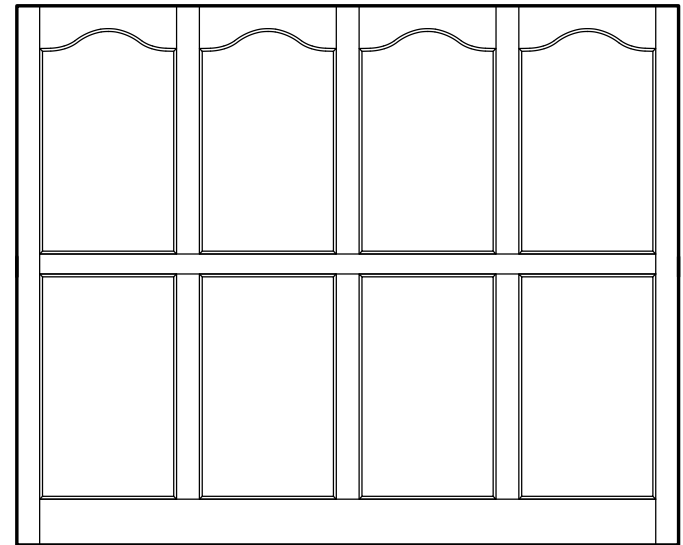

Style **410-2-WS**
Panel Options: **F,R,G**

Most door styles can be fabricated as wainscoting panels. The styles shown above are just examples of wainscot possibilities. The above examples are shown with 6" bottom rails.

Please specify width of stiles and rails when ordering.

Westwind is able to build wainscoting in any configuration that may be desired. We are able to fabricate odd shaped wainscoting for staircases and any other custom applications based upon various needs.

For all custom designs please provide a drawing showing all stile and rail widths and panel configurations.

MITER DOOR & DRAWER STYLES

Go West!

FIXED PROFILE

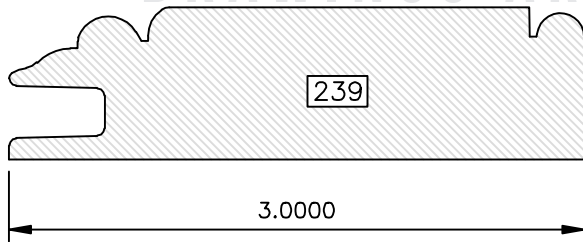
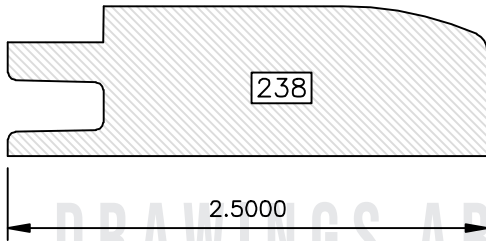
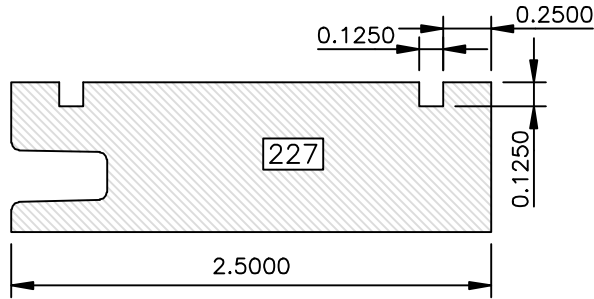
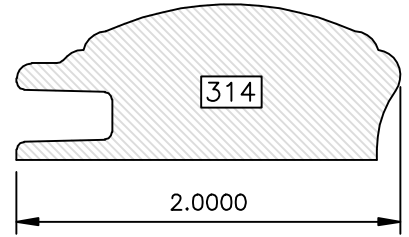
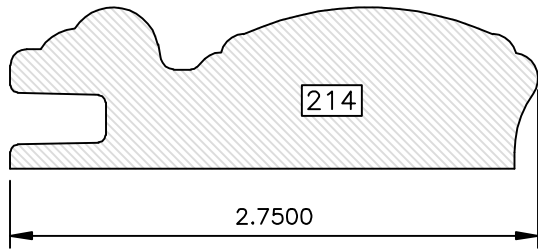

DRAWINGS ARE TO SCALE

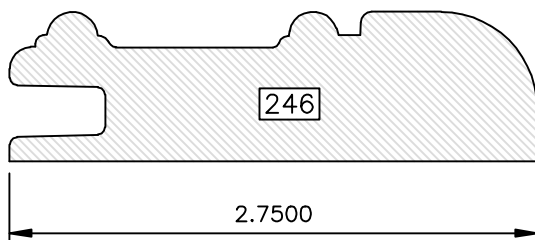
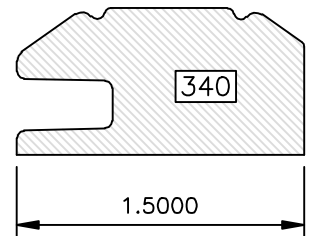
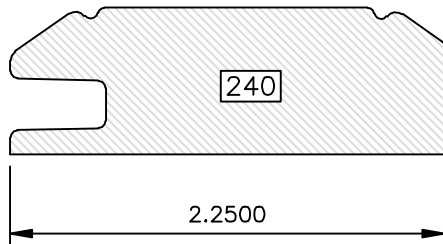

Go West!

MITER DOOR & DRAWER STYLES

FIXED PROFILE

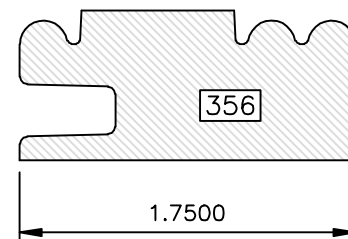
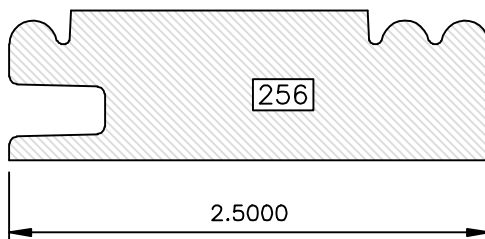
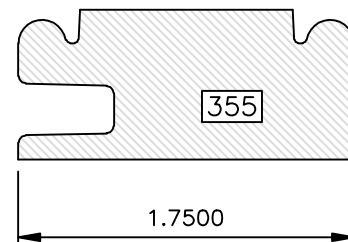
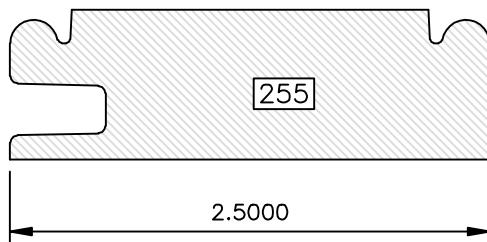
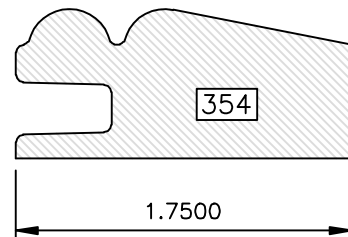
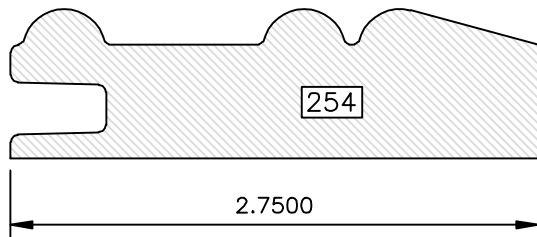
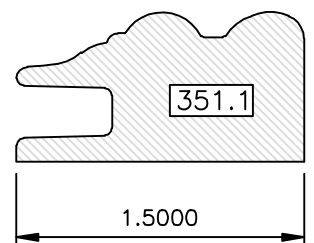
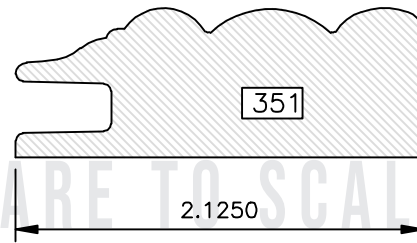
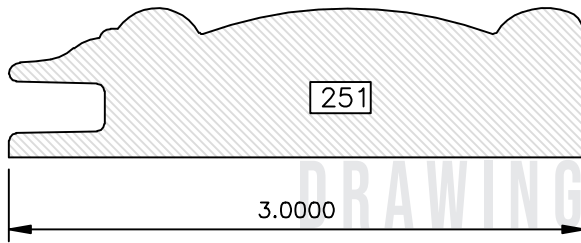
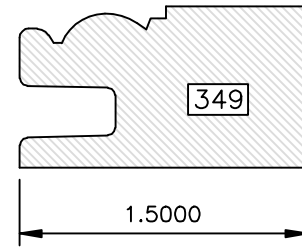
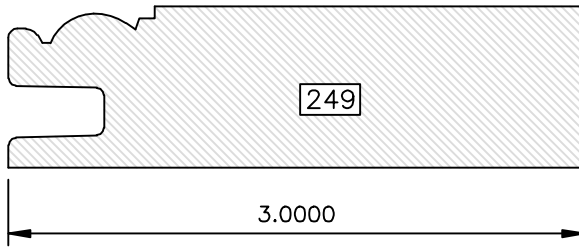
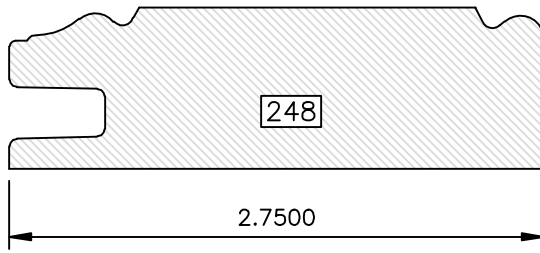

DRAWINGS ARE TO SCALE

MITER DOOR & DRAWER STYLES

Go West!

FIXED PROFILE

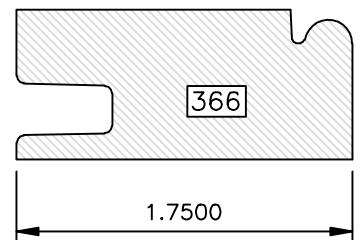
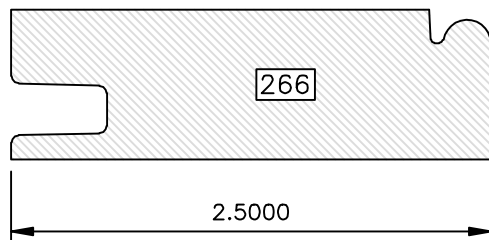
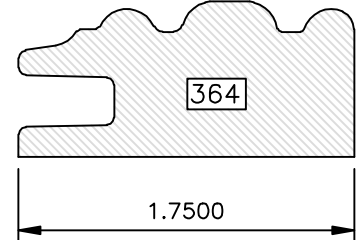
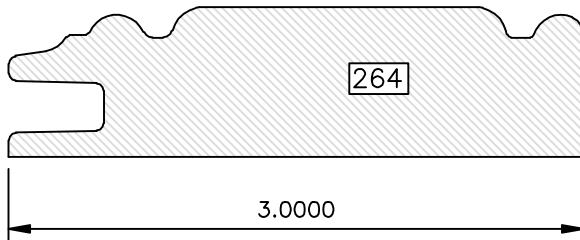
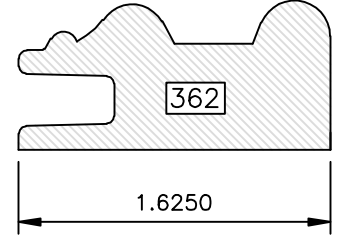
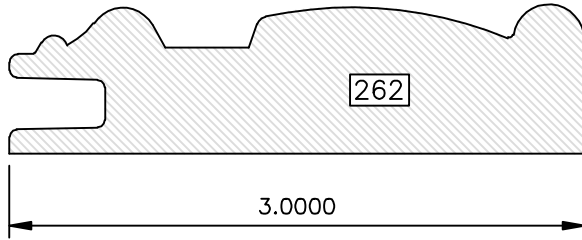
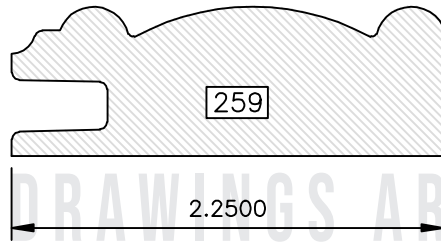
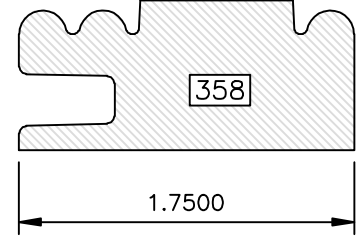
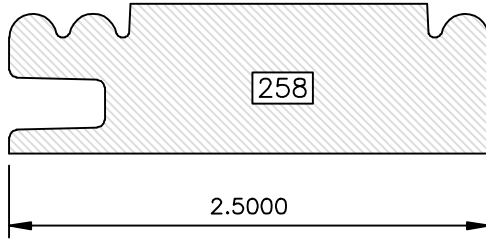
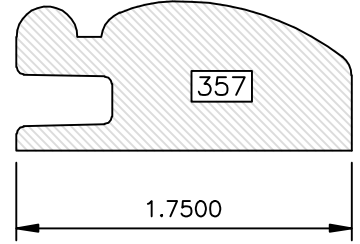
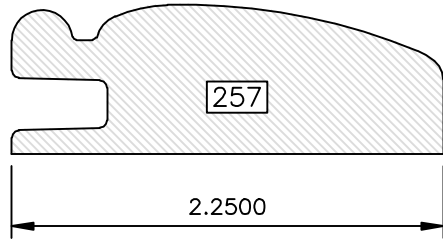

DRAWINGS ARE TO SCALE

Go West!

MITER DOOR & DRAWER STYLES

FIXED PROFILE

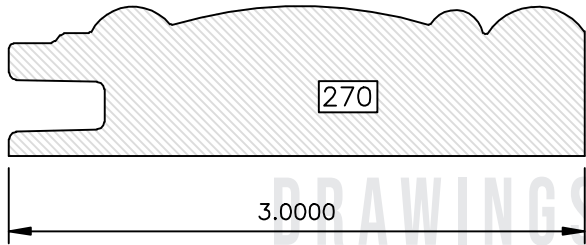
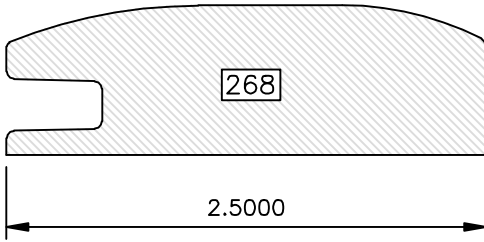
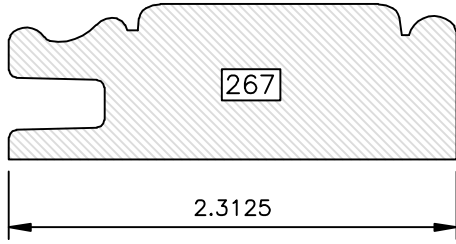

DRAWINGS ARE TO SCALE

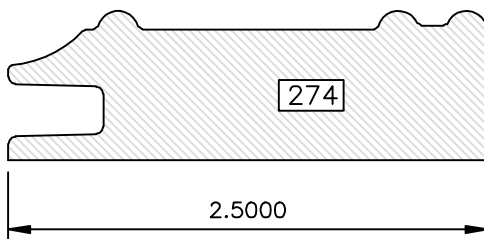
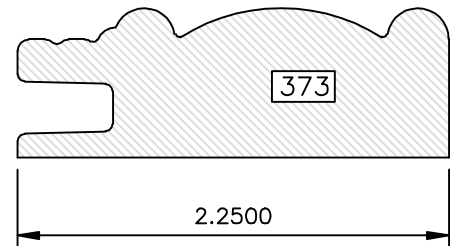
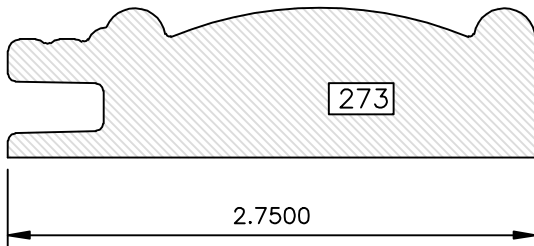
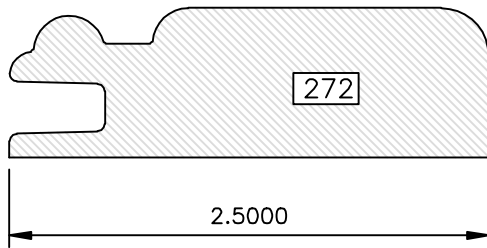

MITER DOOR & DRAWER STYLES

Go West!

FIXED PROFILE

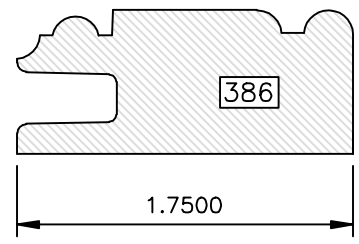
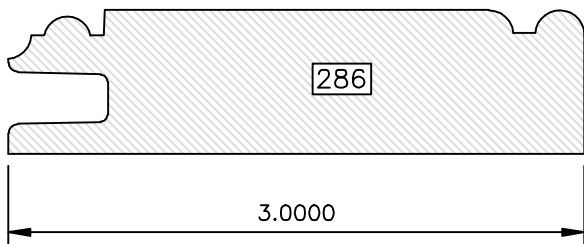
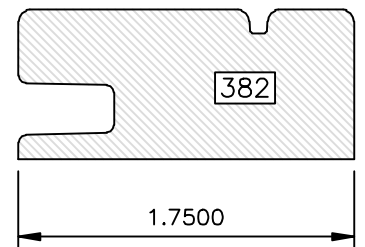
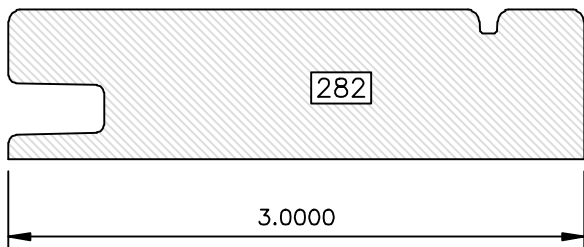
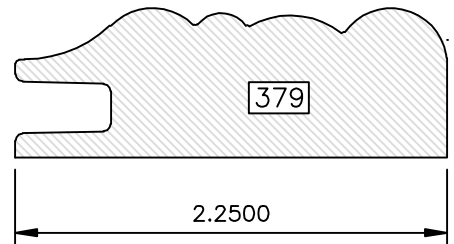
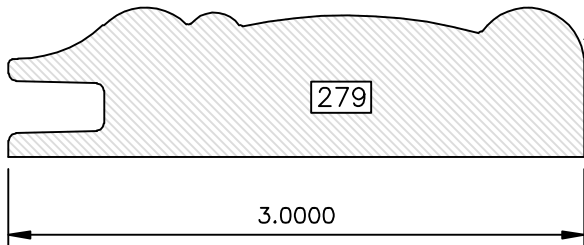
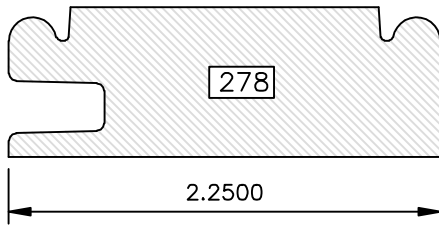
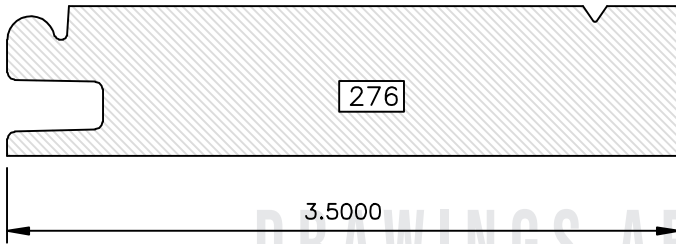
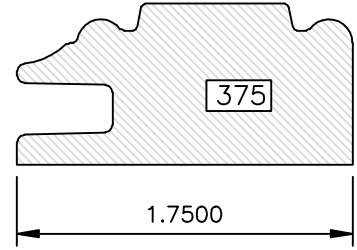
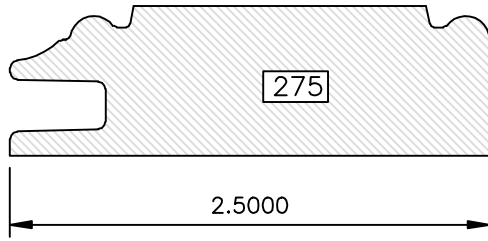

DRAWINGS ARE TO SCALE

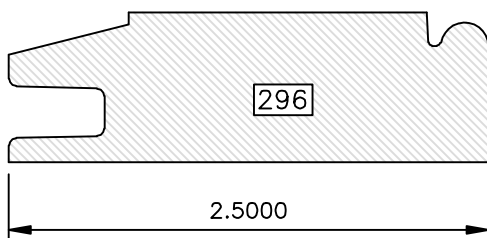
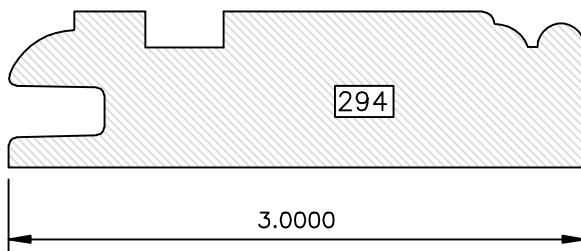
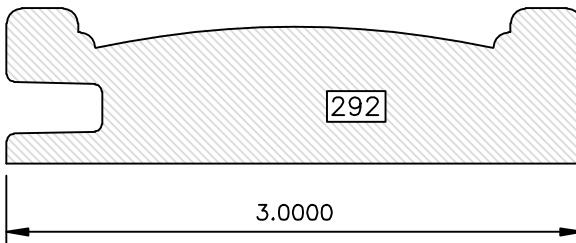
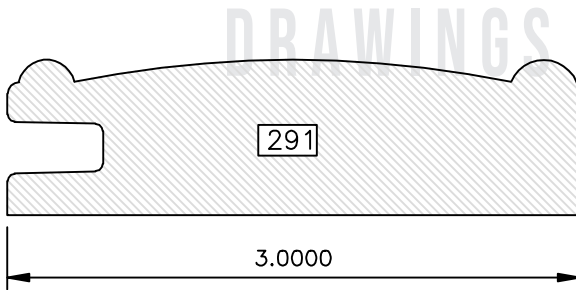
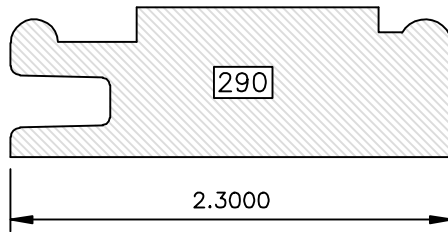
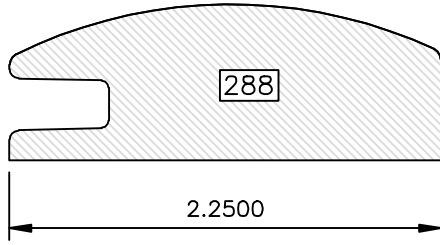

DRAWINGS ARE TO SCALE

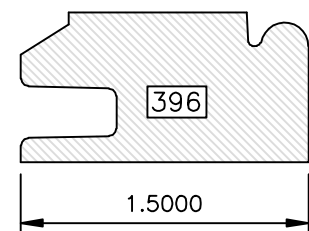
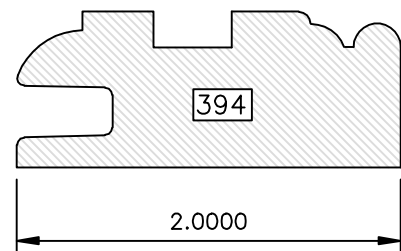
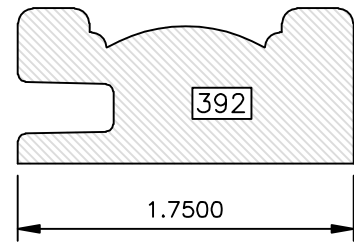
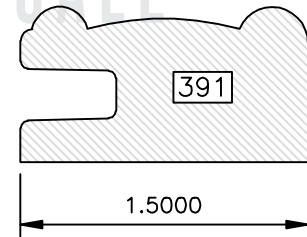

MITER DOOR & DRAWER STYLES

Go West!

FIXED PROFILE

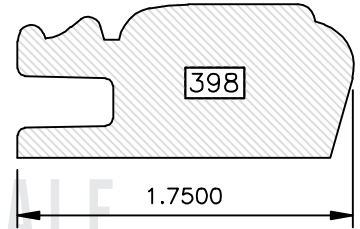
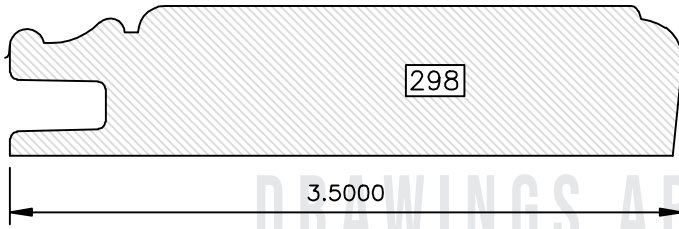
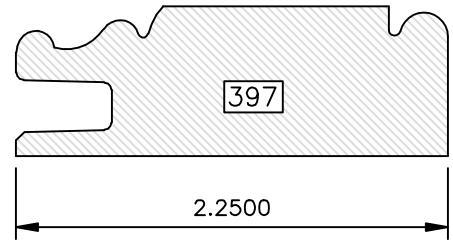
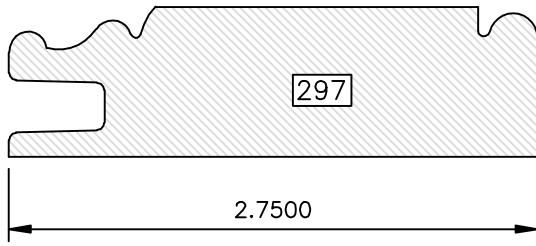

DRAWINGS ARE TO SCALE

Go West!

MITER DOOR & DRAWER STYLES

VARIABLE OUTSIDE PROFILE

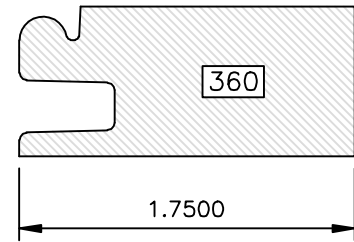
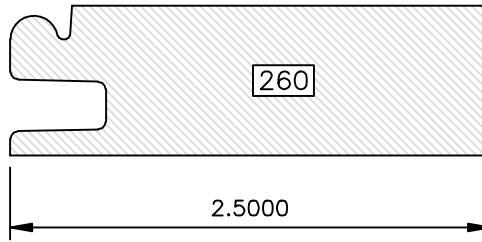
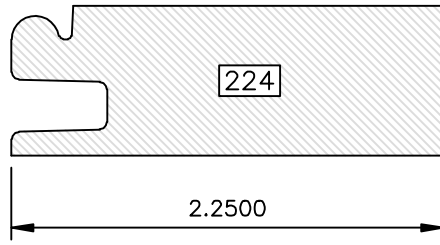

DRAWINGS ARE TO SCALE

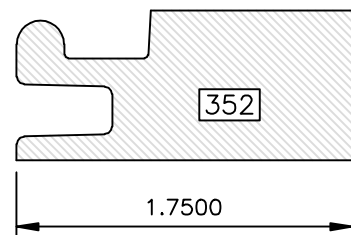
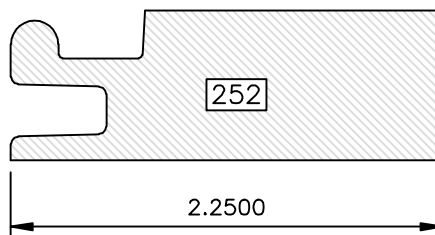
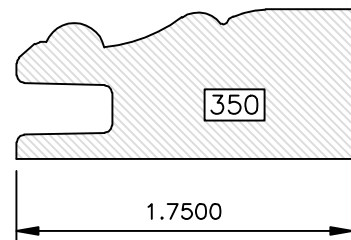
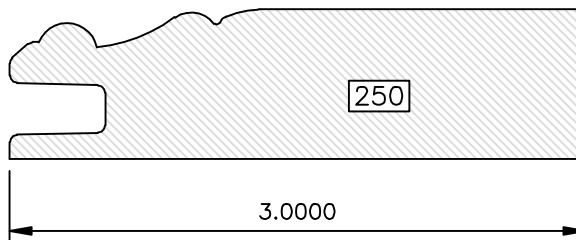
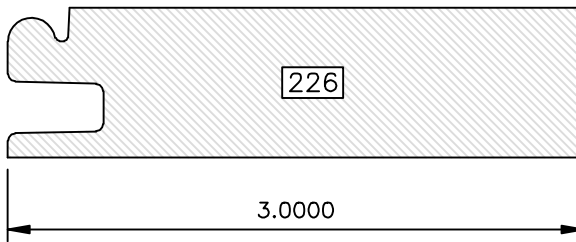
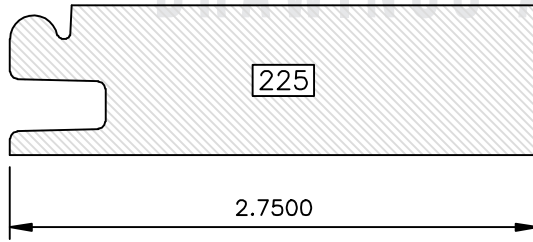

MITER DOOR & DRAWER STYLES

Go West!

VARIABLE OUTSIDE PROFILE

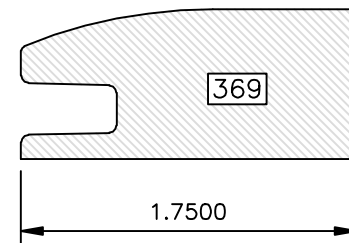
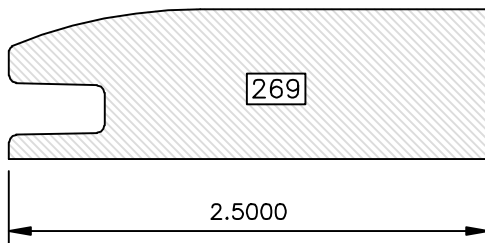
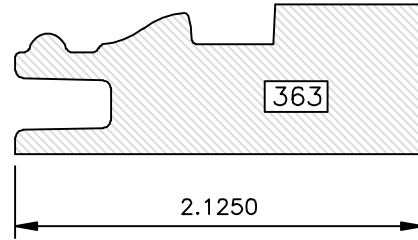
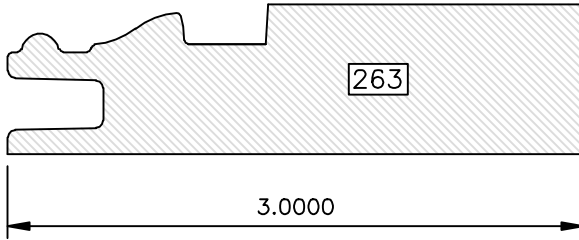
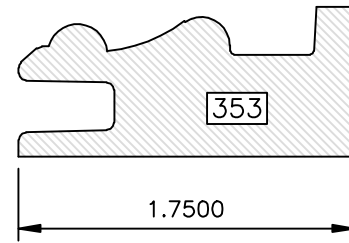
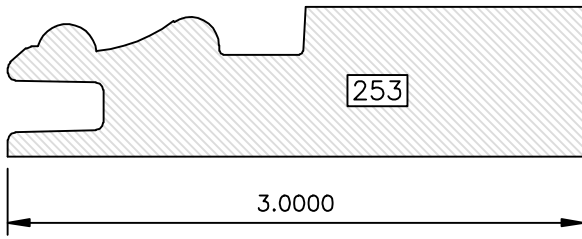

DRAWINGS ARE TO SCALE

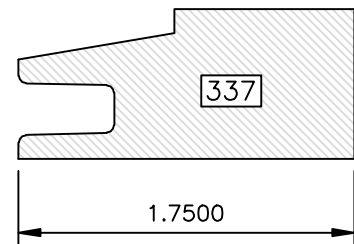
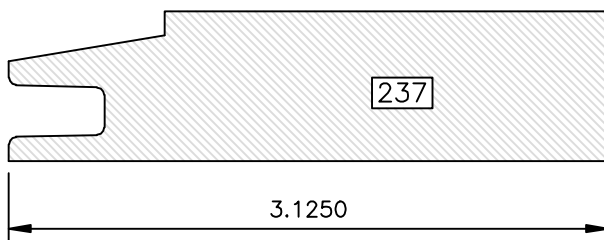

Go West!

MITER DOOR & DRAWER STYLES

VARIABLE OUTSIDE PROFILE

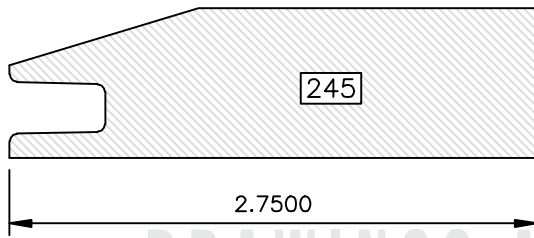
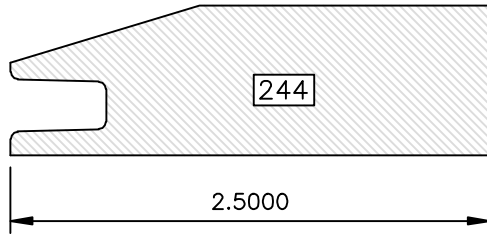
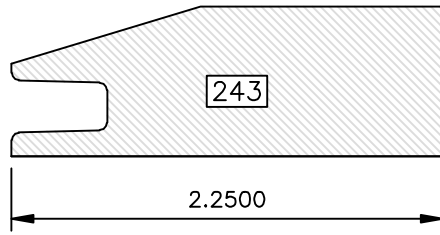

DRAWINGS ARE TO SCALE

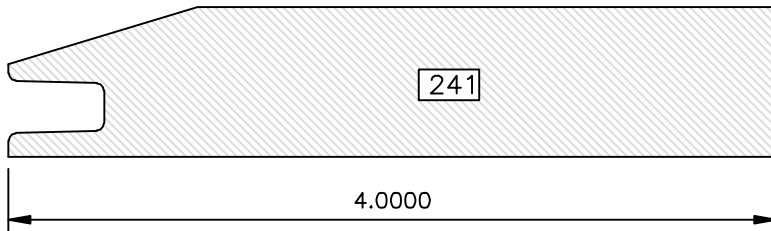
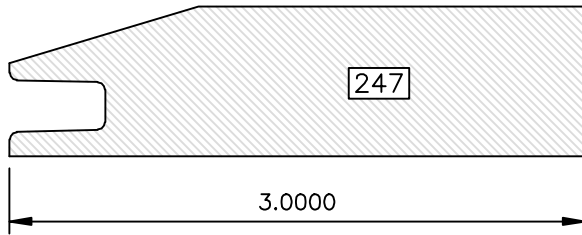

MITER DOOR & DRAWER STYLES

Go West!

VARIABLE OUTSIDE PROFILE

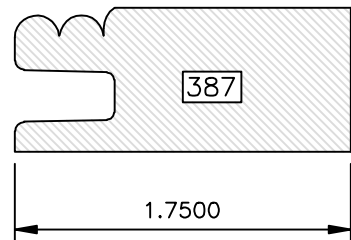
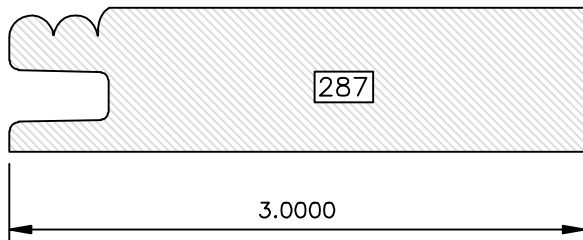
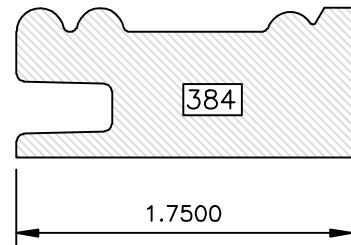
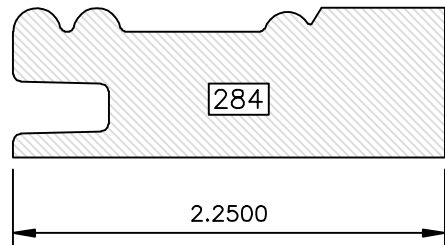
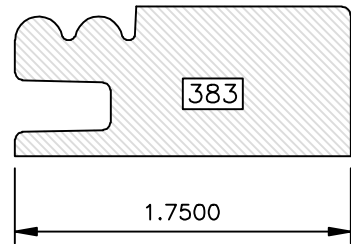
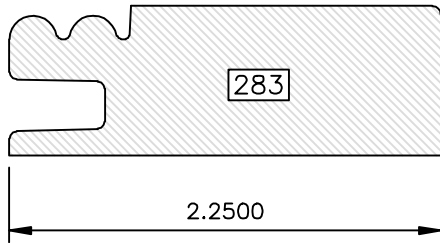
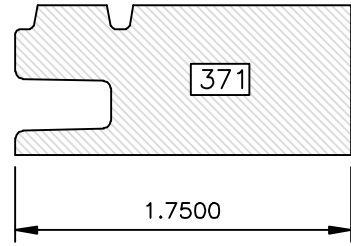
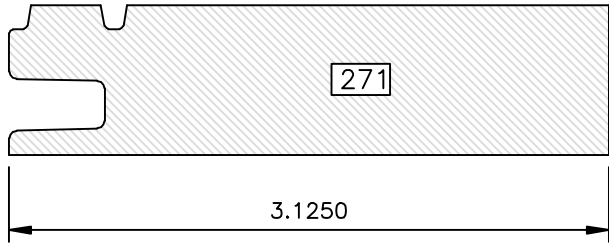

DRAWINGS ARE TO SCALE

MITER DOOR & DRAWER STYLES

VARIABLE INSIDE & OUTSIDE PROFILE

All our frame profiles are available for the inside frame but only the following edges are available for the outside profile: 802, 804, 805, 806, 807, 809, 810, 811, 812, 813, 814, 818, 820, 823, 824, 827, 831, 832, 833, 834, 835, 837, 838, 840, 845, 847, 854, 857, 860, 861, 887, 888, 893, 894, 895 & 896.

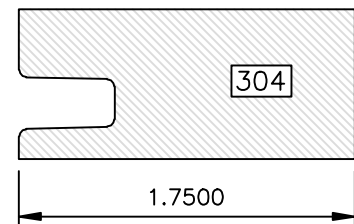
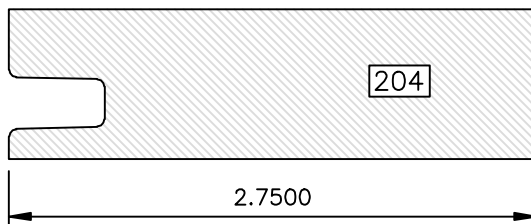
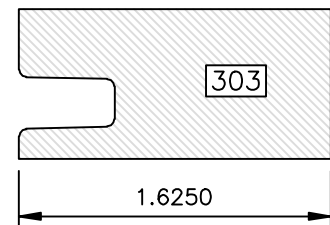
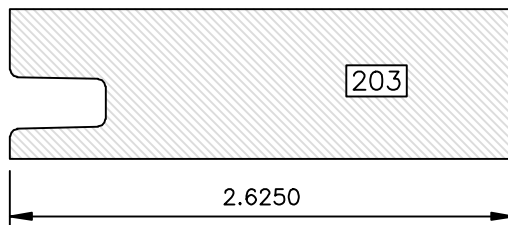
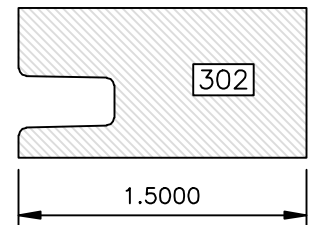
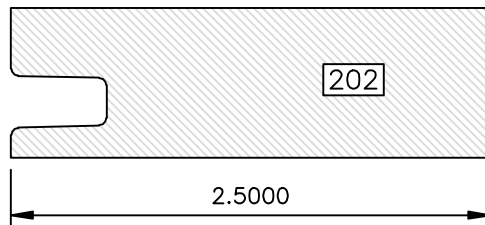
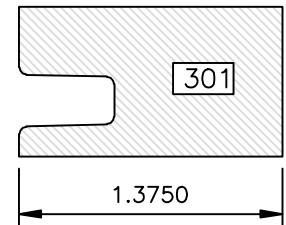
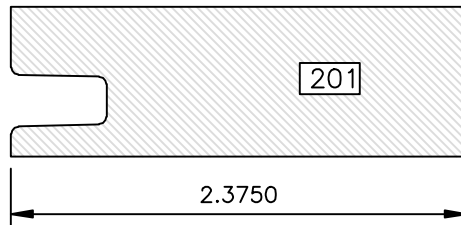
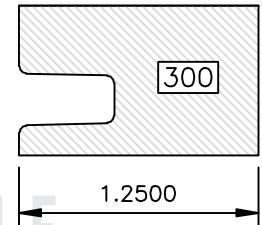
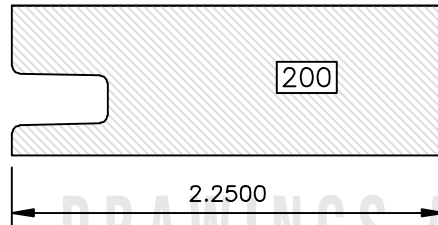

DRAWINGS ARE TO SCALE

MITER DOOR & DRAWER STYLES

Go West!

VARIABLE INSIDE & OUTSIDE PROFILE

All our frame profiles are available for the inside frame but only the following edges are available for the outside profile: 802, 804, 805, 806, 807, 809, 810, 811, 812, 813, 814, 818, 820, 823, 824, 827, 831, 832, 833, 834, 835, 837, 838, 840, 845, 847, 854, 857, 860, 861, 887, 888, 893, 894, 895 & 896.

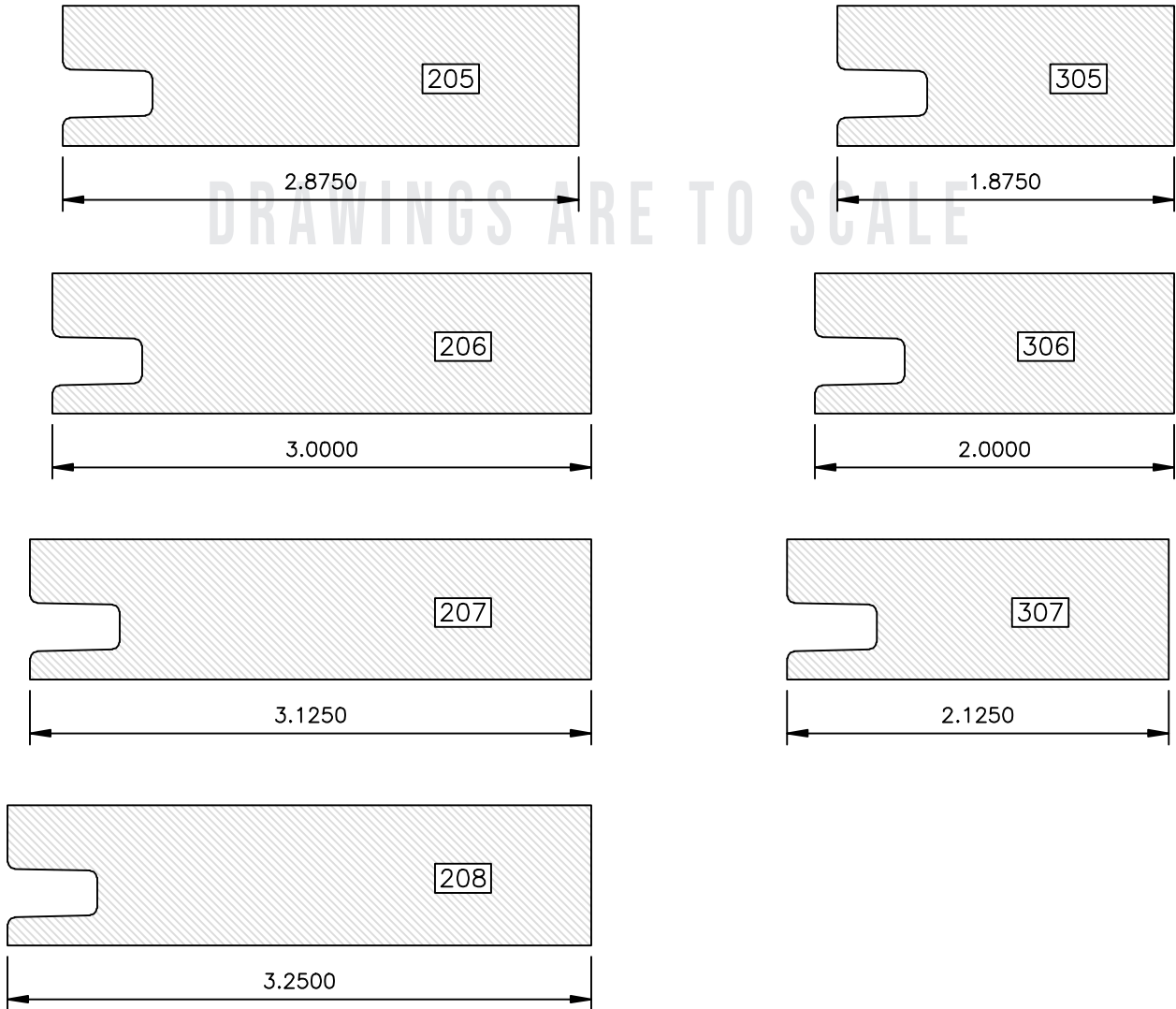

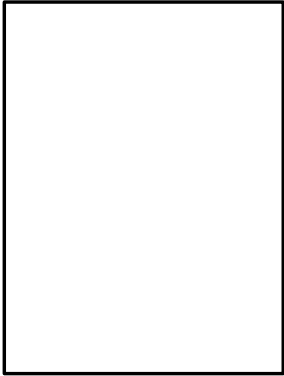

Glued Up Panel (GU)
Chart Below

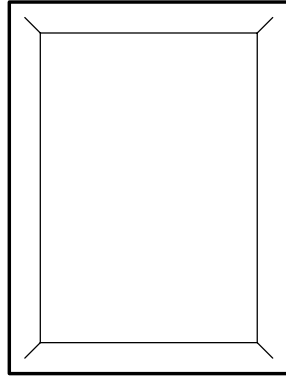

Raised Panel Only (RP)
Chart Below

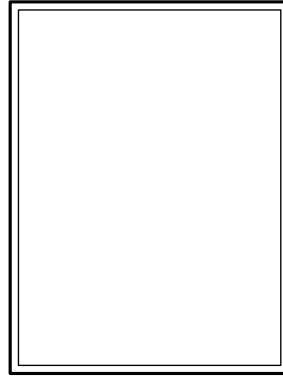

Style 440
See Chart Below

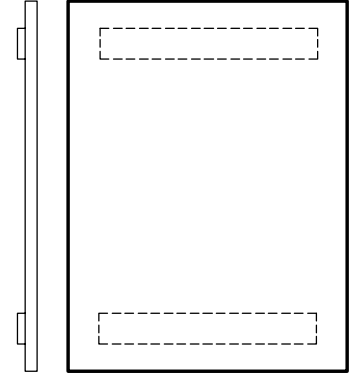

Style 442
Panel Options: **Slab Only**
See Chart Below

**Because of the potential of a solid slab door to warp, twist, or cup; Westwind only guarantees the 442 style.
The battens are screwed 2 1/4" away from all slab edges. 442 Minimum Width is 8 1/2".**

Product	Treatment	Thickness of Part
GU	Rough	.9375"
GU38	180 Grit Face and Back w/ Rough Edges	.375"
GU12	180 Grit Face and Back w/ Rough Edges	.500"
GU58	180 Grit Face and Back w/ Rough Edges	.625"
GU34	180 Grit Face and Back w/ Rough Edges	.750"
440	180 Grit Face and Back	.780"
442	180 Grit Face and Back	.780"
RP	180 Grit Face and Back	Varies

GU's are available with a saw cut edge only.

All slabs over 12 total square feet or over 32" wide are subject to an upcharge.

440's thru 442's are available with any edge shown on our edge profile pages (starting on page 25).

Minimum square footage for GU's, 440, 442, and 441 is 1 square foot.

Any profiled slab ordered with one dimension less than 3" is subject to an upcharge.

APPLIED MOLDING STYLES

Go West!

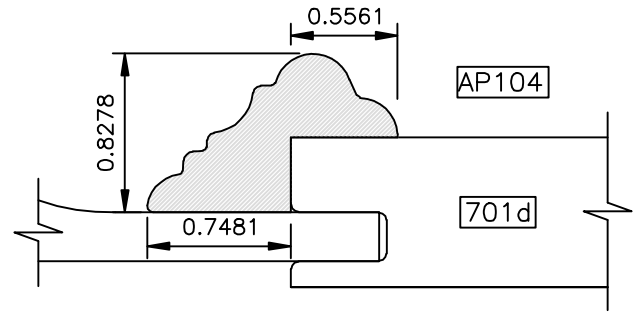
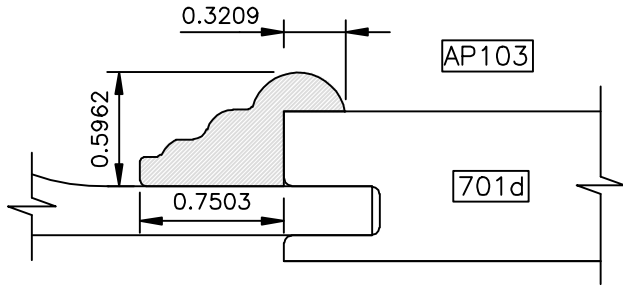
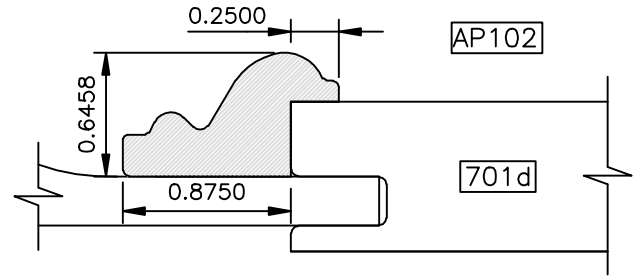
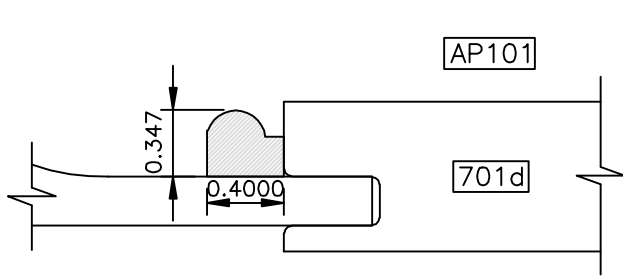

DRAWINGS ARE TO SCALE

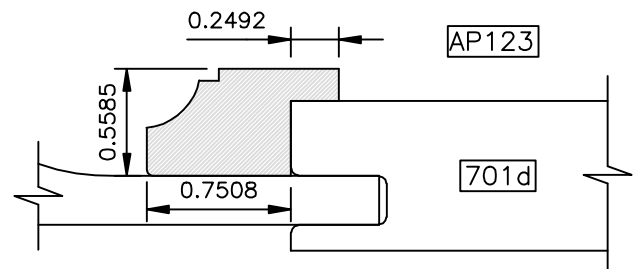
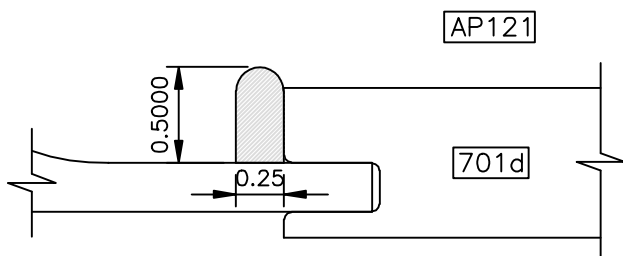
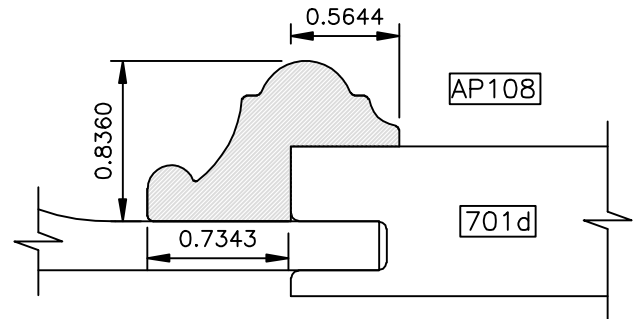
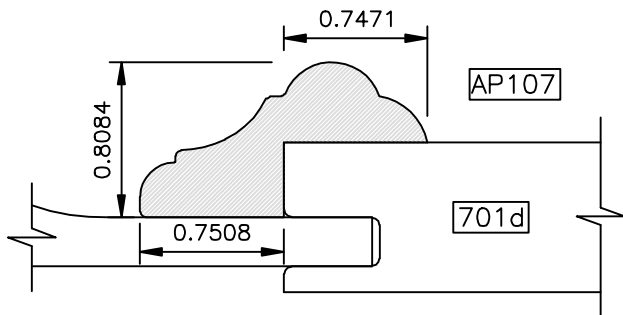
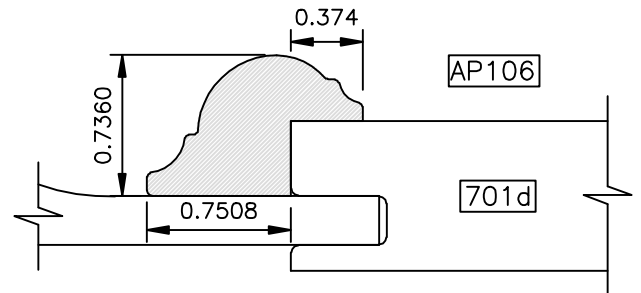
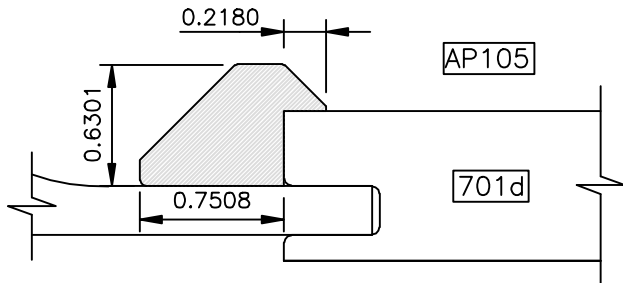

APPLIED MOLDING STYLES

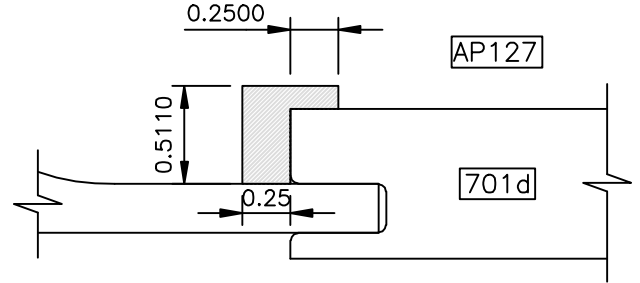
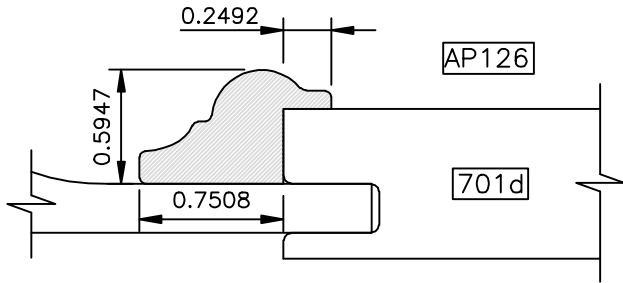
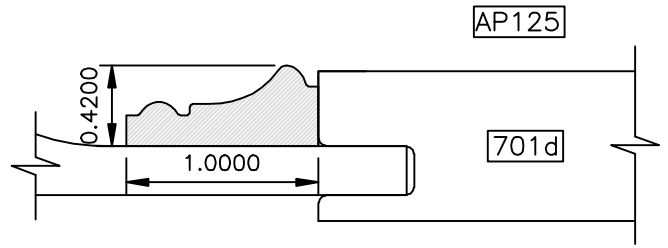
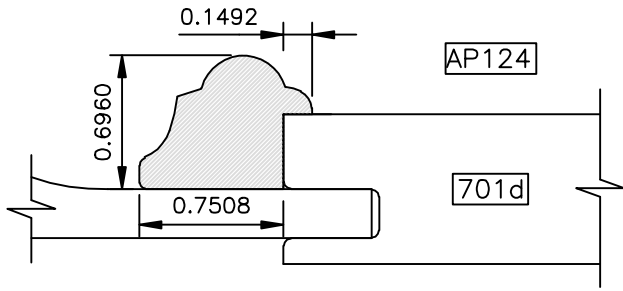

DRAWINGS ARE TO SCALE

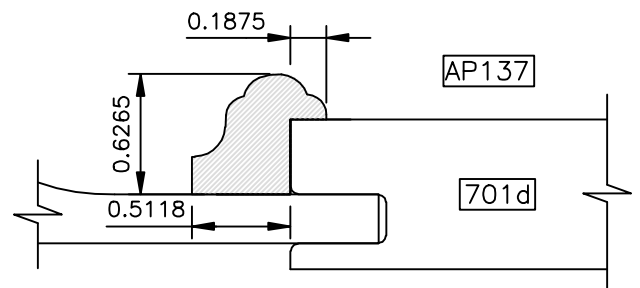
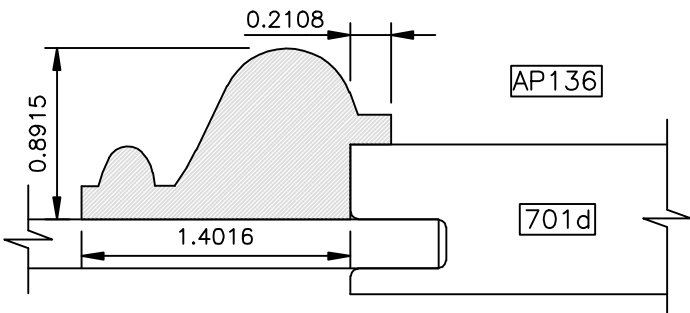
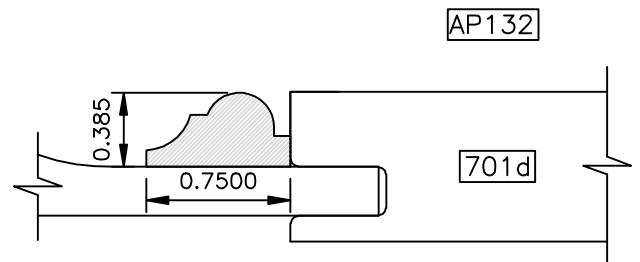
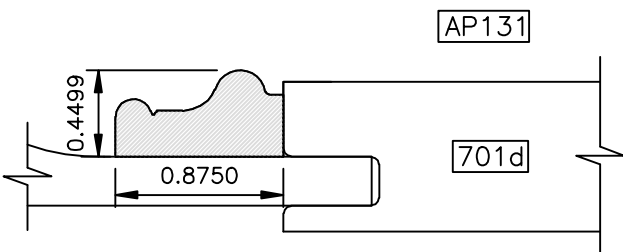
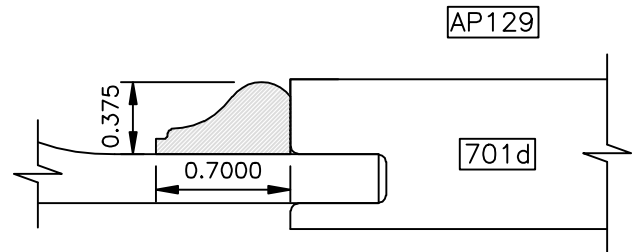
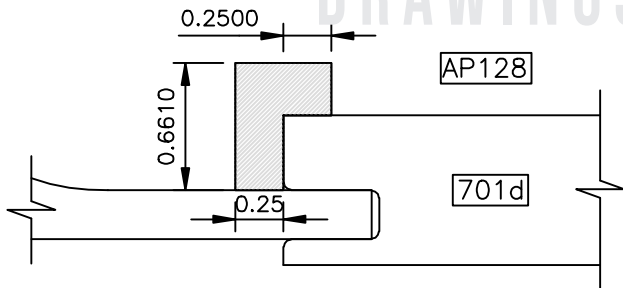

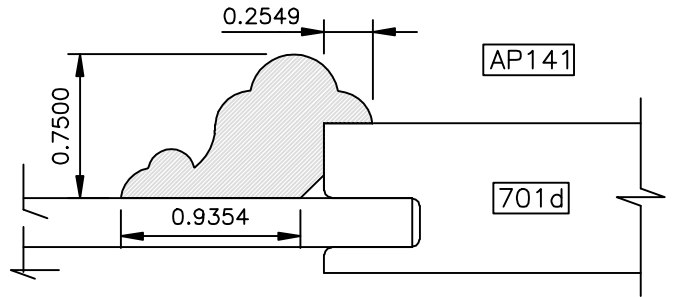
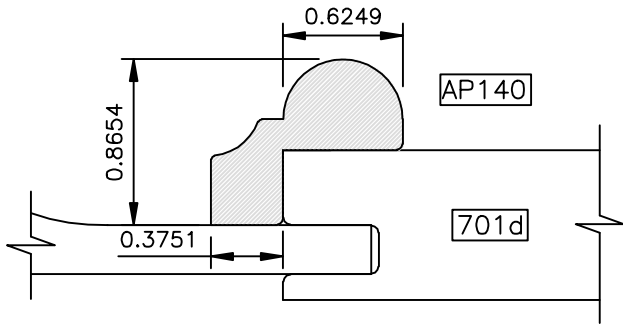
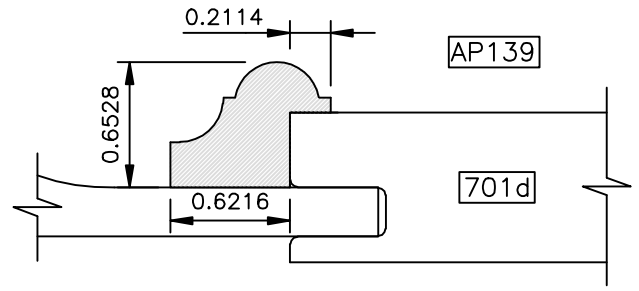
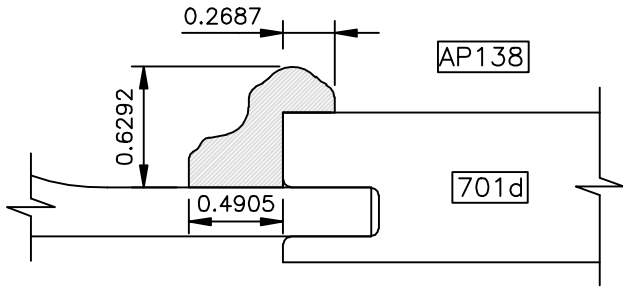

DRAWINGS ARE TO SCALE

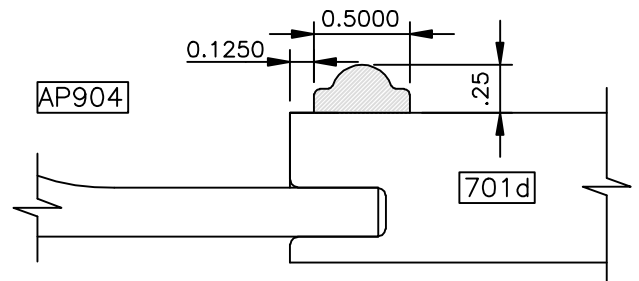
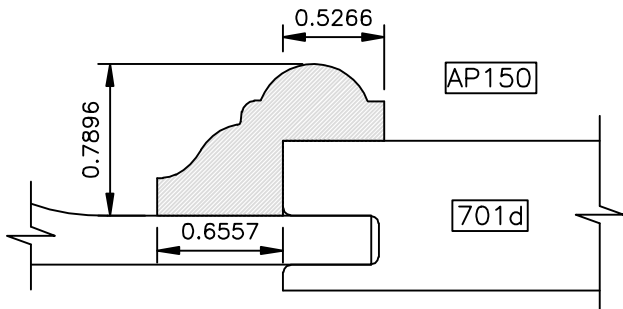
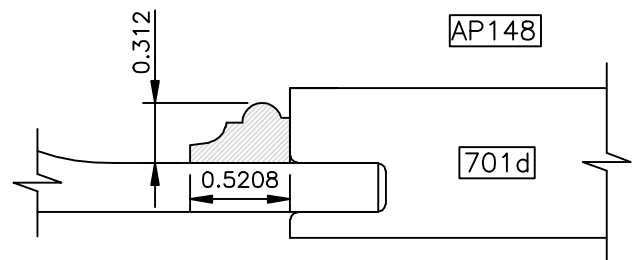
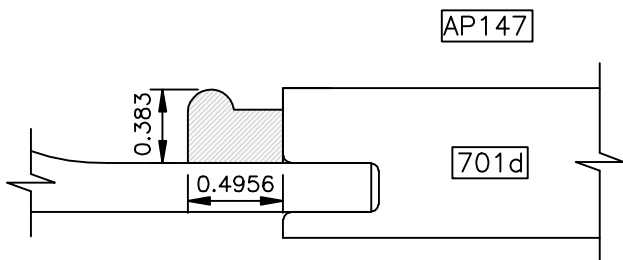
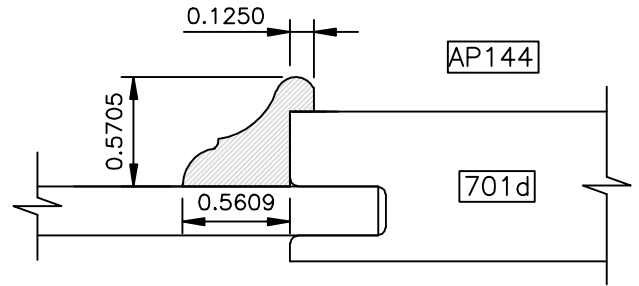
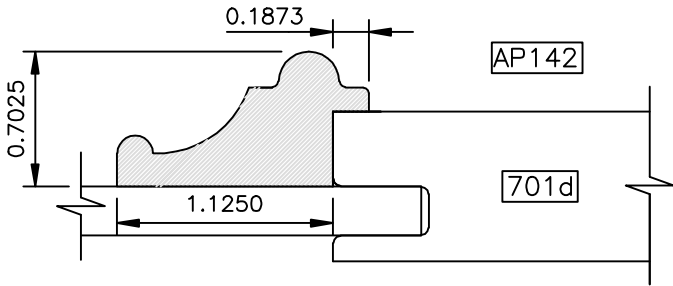

APPLIED MOLDING STYLES

Go West!

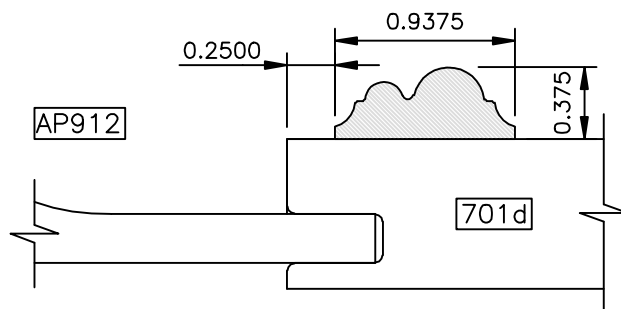
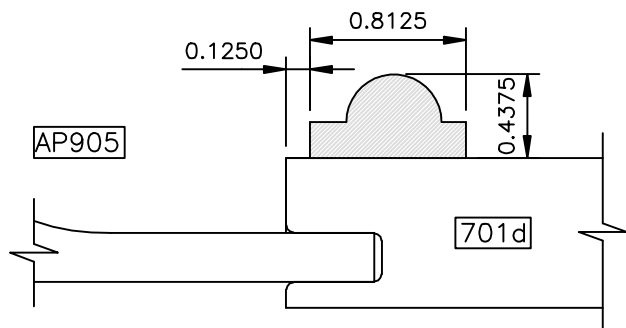

DRAWINGS ARE TO SCALE

MICRO RAIL SLAB DOOR PROFILES

Go West!

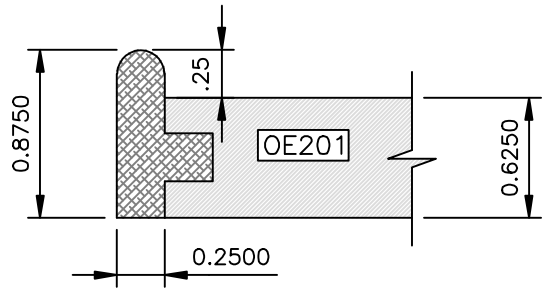
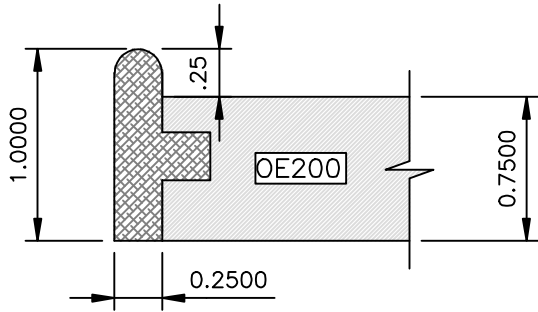

Only available in MDF panels

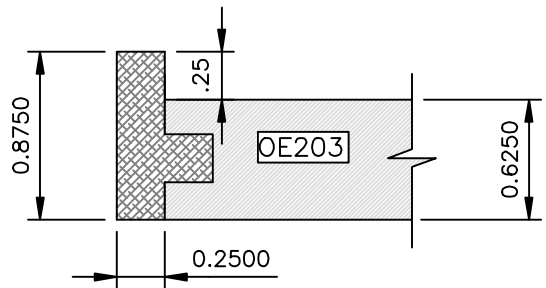
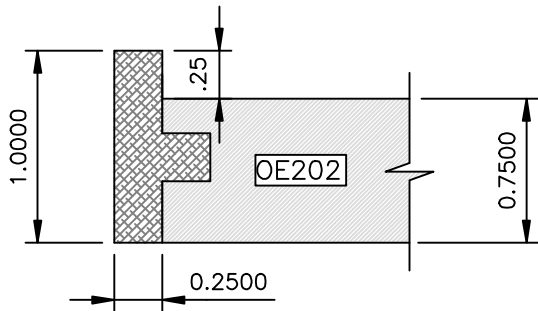

Only available in MDF panels

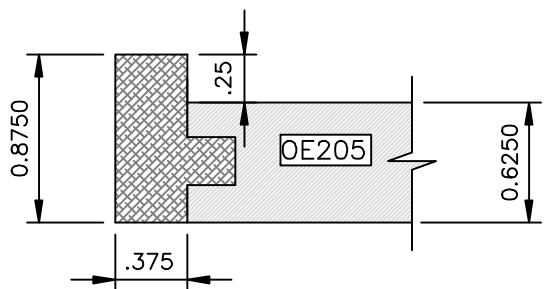
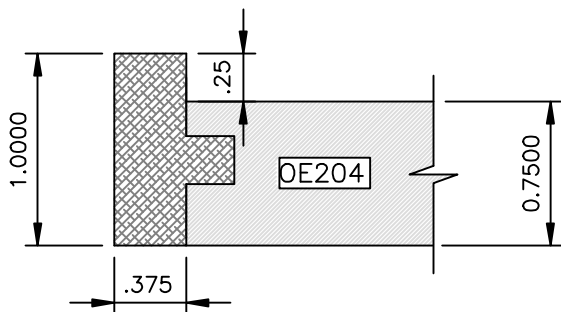

Only available in MDF panels

MICRO RAIL SLAB DOOR PROFILES

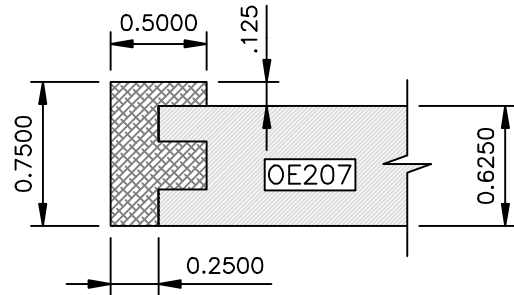
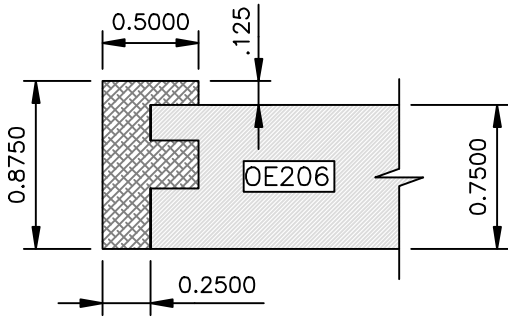

Only available in MDF panels

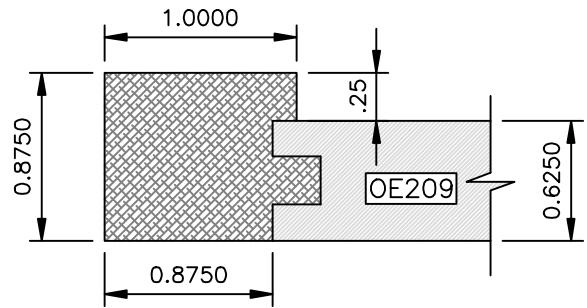
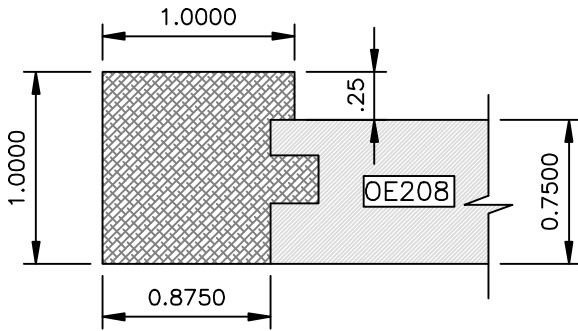

Only available in MDF panels

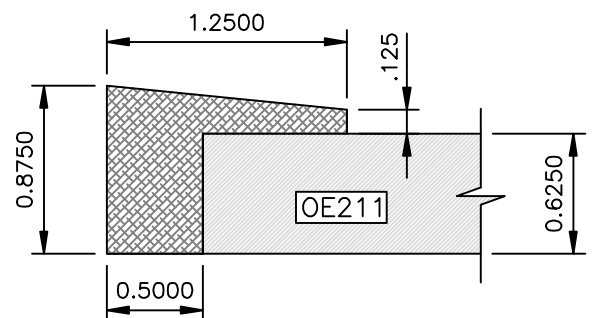
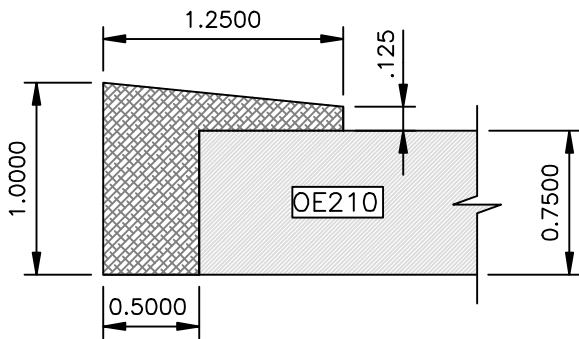

Only available in MDF panels

MICRO RAIL SLAB DOOR PROFILES

Go West!

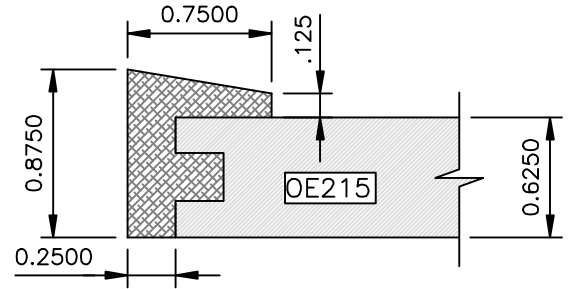
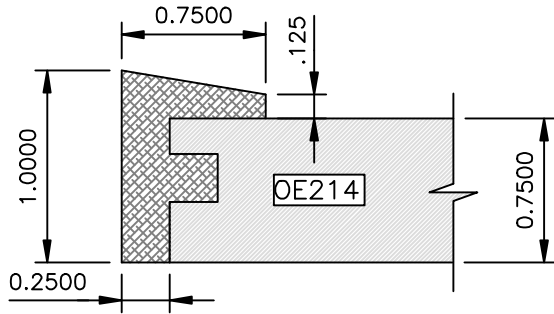

Only available in MDF panels

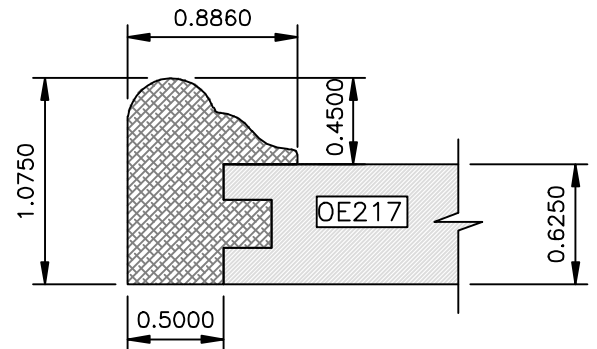
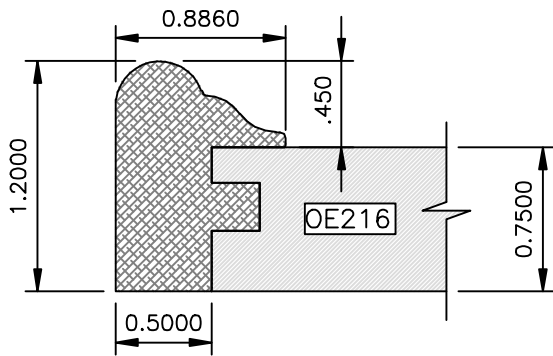

Only available in MDF panels

MICRO RAIL SLAB DOOR PROFILES

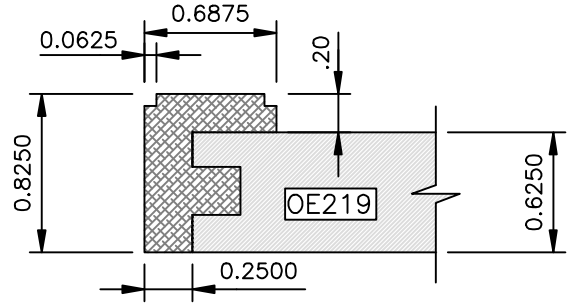
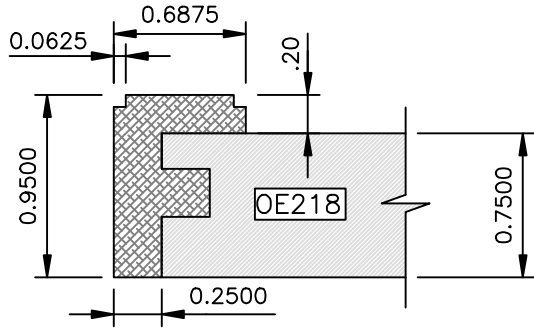

Only available in MDF panels

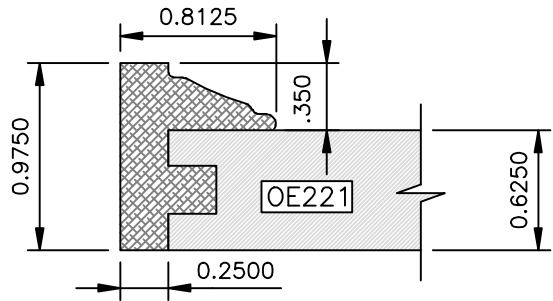
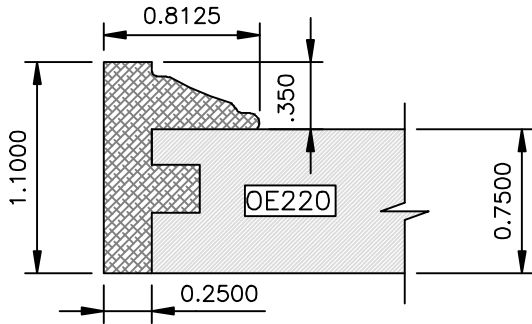

Only available in MDF panels

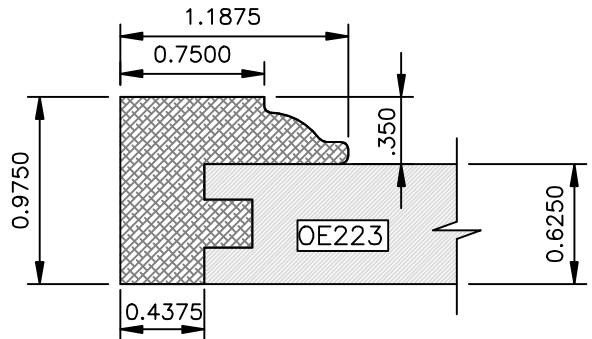
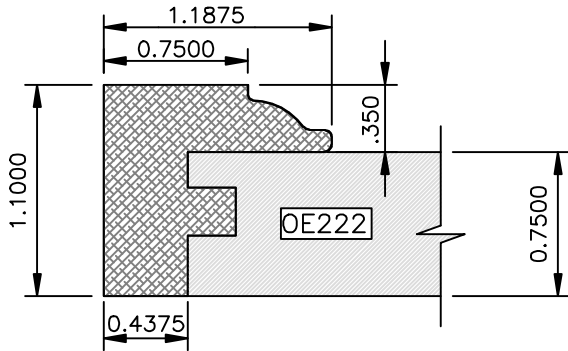

Only available in MDF panels

Hinge Options

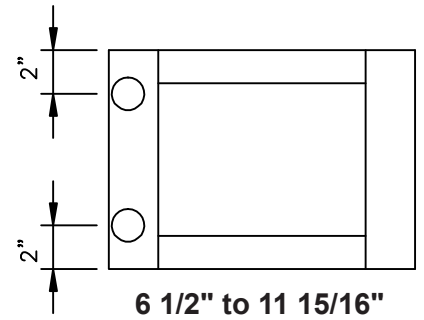
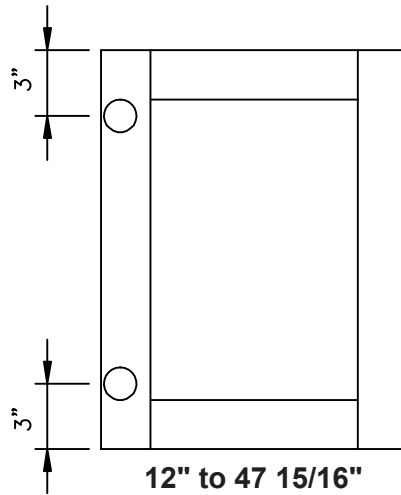
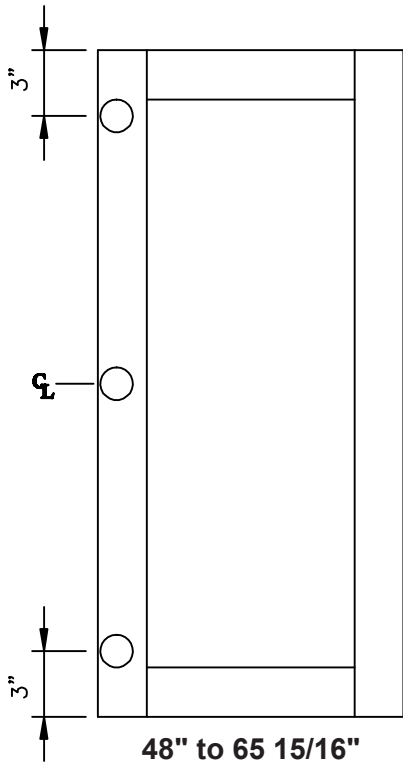

All doors 66" and over receive four hinge bores.

Standard Hinge Boring

Cup Blum (BH) and European (EH): Standard distance from edge is 3mm, 1/2" deep. Hinge placement as shown above. If a custom distance from edge is needed, please inform a customer care representative.

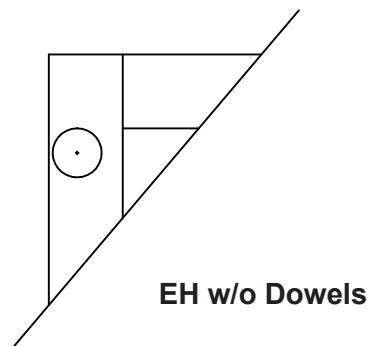
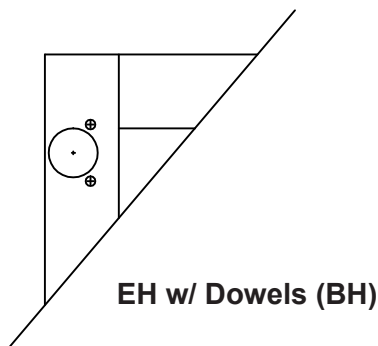

Fingerpull Options

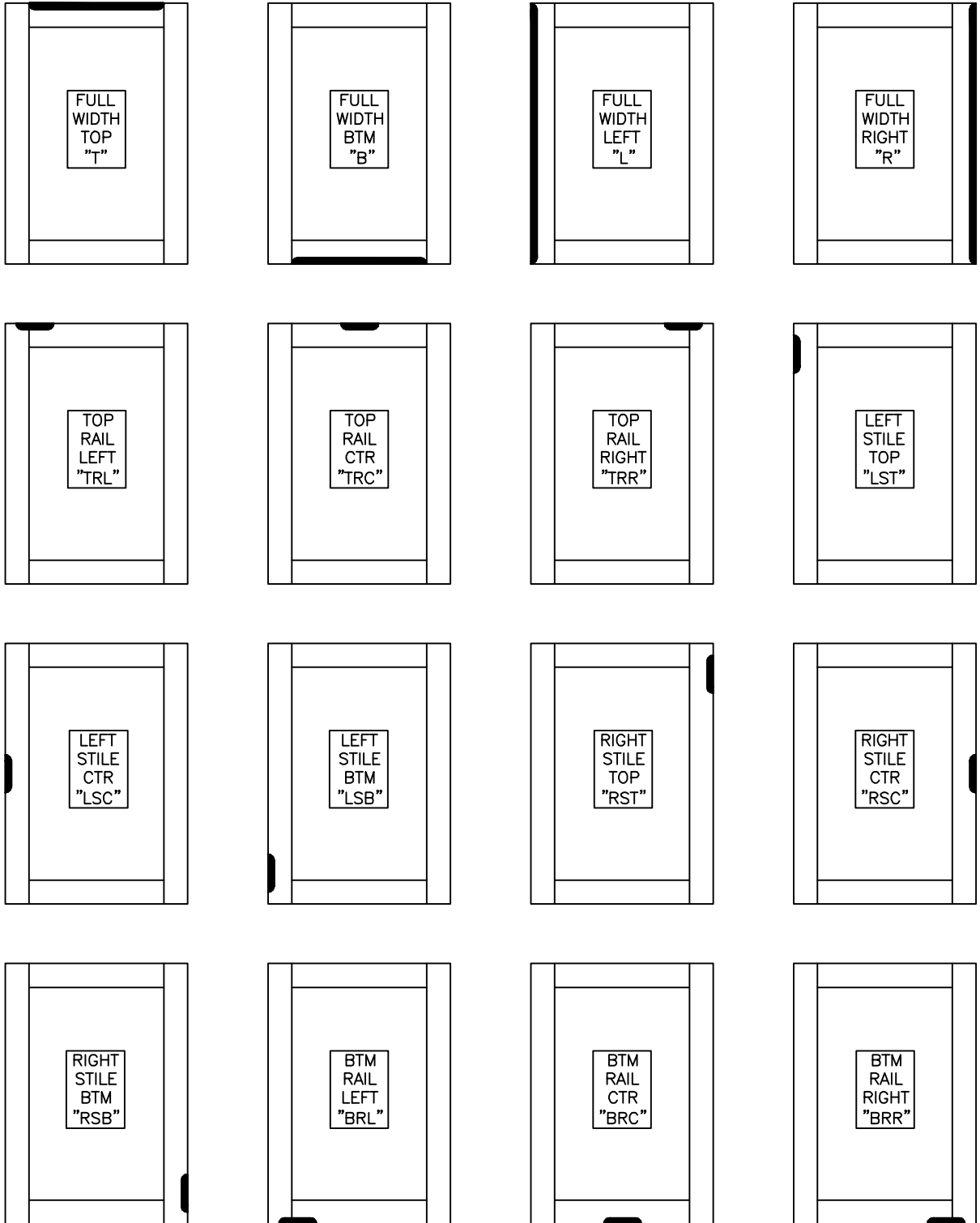

Minimum Door Height and Width for fingerpulls is 6 ½" x 6 ½".

Fingerpull Options

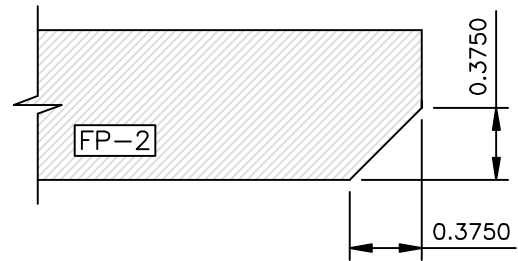
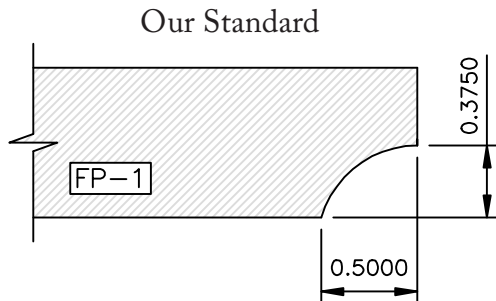

Please use abbreviations below and enter in the special notes column on order form to specify placement of 4" fingerpulls.

All pulls are viewed from the face of doors and drawer fronts.

	Right	Center	Left
Top Rail	TRR	TRC	TRL
Bottom Rail	BRR	BRC	BRL
	Top	Center	Bottom
Right Stile	RST	RSC	RSB
Left Stile	LST	LSC	LSB

Please use abbreviations below and enter in the special notes column on order form to specify placement of full length fingerpulls.

All pulls are viewed from the face of doors and drawer fronts.

Top	T
Bottom	B
Right	R
Left	L

Minimum Door Height and Width for fingerpulls is 6 ½" x 6 ½".

Accent Plugs, Nails and Clavos

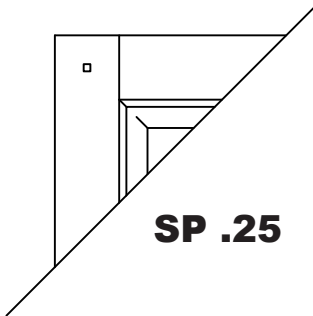

SP .25

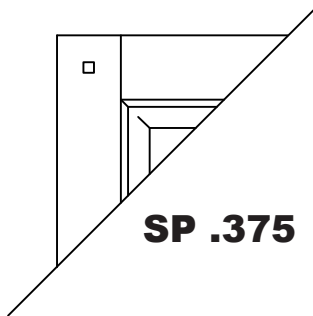

SP .375

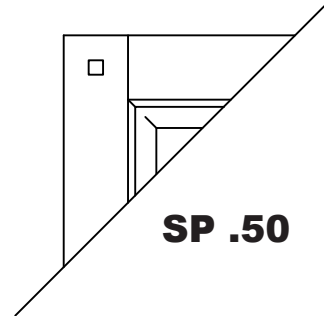

SP .50

Above is an example of plug, nail, and clavos placement. We are always ready to customize for any need that may arise. All plugs are sanded flush, unless otherwise specified.

Custom Edge Options

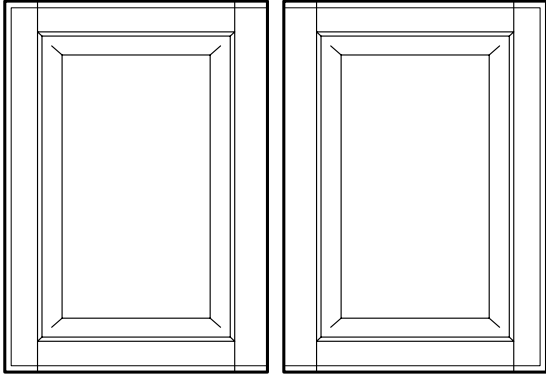

Westwind gives you the option to leave one edge of the door square while edging the other three. When ordering pair doors, the edge that is to be left square must be specified: Left (NELS) or Right (NERS). These codes should be used in the special notes column on the order form.

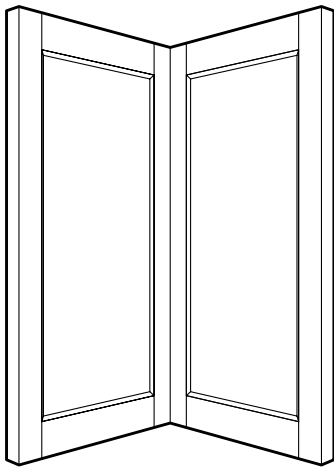

Lazy Susan Butt Joint

On Lazy Susan Butt Doors, we recommend that one door have a $\frac{3}{4}$ " wider stile than the specified frame size to make them look symmetrical when they are fastened together.

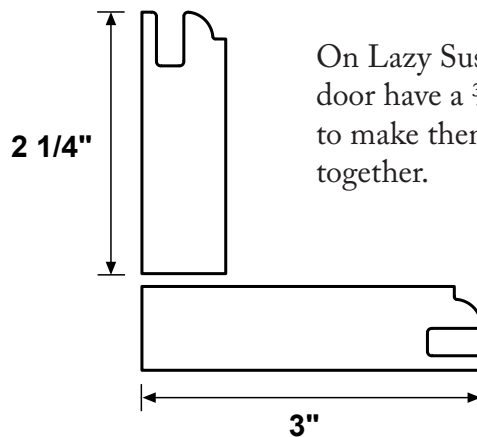

DOVETAIL DRAWER BOXES

Go West!

SOLID WOOD DRAWER BOXES

Our standard solid wood drawers have 5/8" thick sides. Drawers are fully assembled and ready to install. Dovetails are sanded smooth and finished after assembly.
Min height 2", Max height 15", Max width 52"

Wood Species (Sides):

Hard White Maple, Superior Grade Euro-Beech, Color Grade Euro-Beech, Alder & Cherry

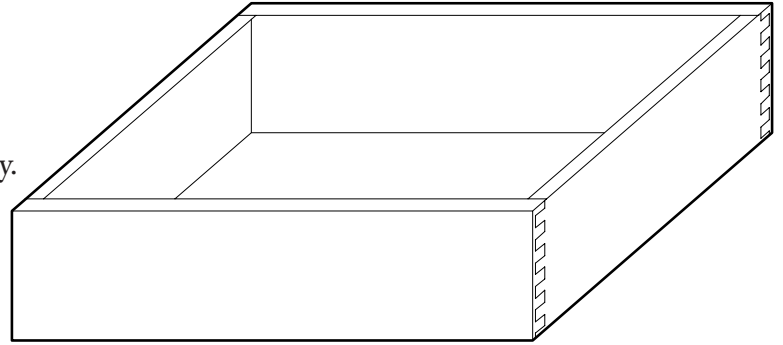

Dovetail Drawer Box

Wood Species (Bottoms): Maple, Beech & Melamine

** Please note: If your species is not listed, please call the office for availability*

PLYWOOD DRAWER BOXES

Two Options of 15mm (5/8" nominal) Baltic Birch plywood are available.

Wood Species (Sides): Factory Finished Baltic Birch Plywood, Pre-Finished Baltic Birch Plywood

Wood Species (Bottoms): Birch

ROLLOUTS

Several different roll out options are available:

Standard Scoop, Show Front, Narrow Scoop, Ear Drawers, 5/8" Bottom Lip, Straight Tapered Drawer, Angled Tapered Drawer & Curved Tapered Drawer

SPECIALTY DRAWERS

We have an array of specialty drawers to accommodate most any drawer box needs.

Several different specialty drawer options are available:

Sink Drawer U, Sink Drawer R, Sink Drawer L, Corner Drawers, Straight Tapered Drawer, Angled Tapered Drawer & Curved Tapered Drawer

LASER ENGRAVED LOGO

Custom laser engraving of your logo is available on any of our solid wood & plywood drawer materials.

** Please note: Logos should be sent in JPEG format and in black and white - no color*

FILE DRAWERS

We offer file drawer options for both standard and legal-size paper. Aligned with either front to back, or side to side 1" aluminum rails. Minimum drawer height is 10 1/4".

Several different file drawer options are available — see next page.

Standard Letter (SLTC)

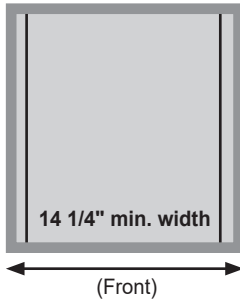

Standard Letter Right Aligned (SLTR)

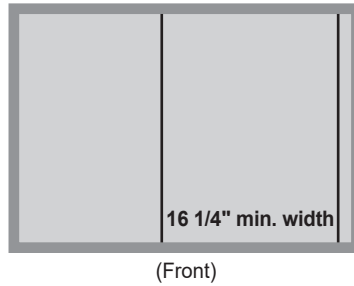

Standard Letter Left Aligned (SLTL)

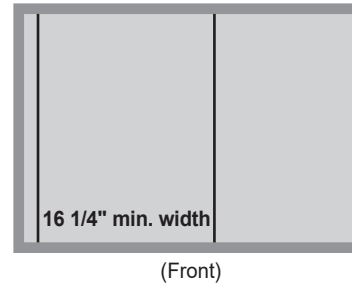

Standard Legal (SLGC)

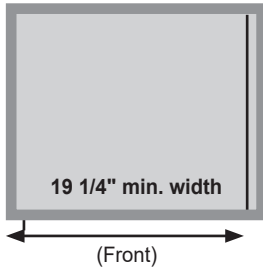

Standard Legal Left Aligned (SLGL)

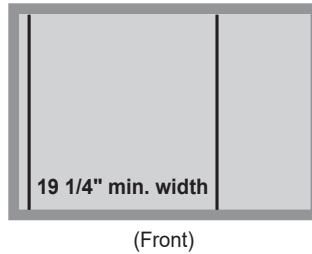

Standard Legal Right Aligned (SLGR)

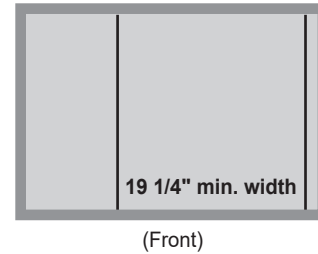

Standard Letter & Legal (SLLC)

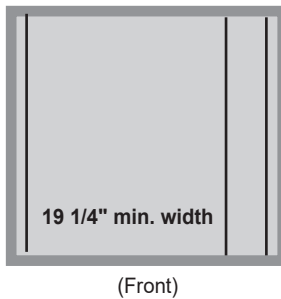

Standard Letter & Legal Left Aligned (SLLL)

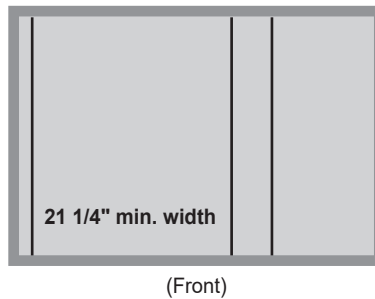

Standard Letter & Legal Right Aligned (SLLR)

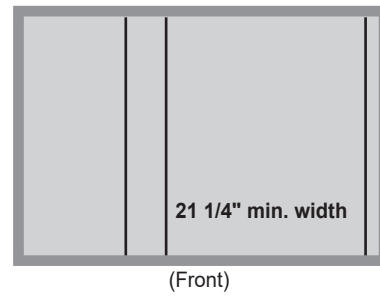

Lateral Letter (LLT)

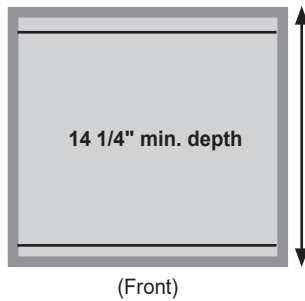

Lateral Legal (LLG)

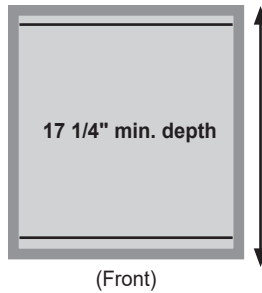

Lateral Letter and Legal (LLL)

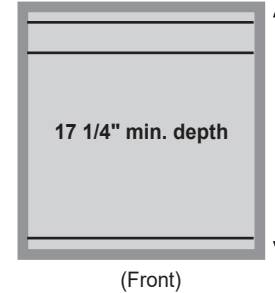

Double Row of SLT (SL2)

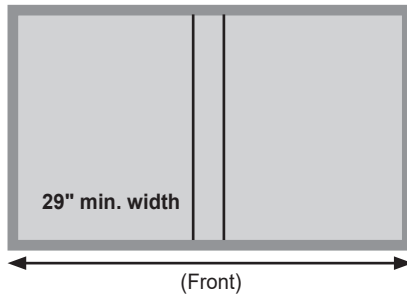

Double Row of Standard Letter/Legal (SLL2)

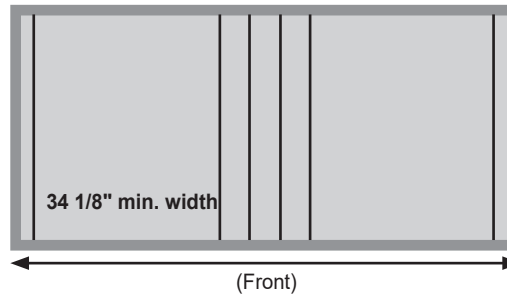

WESTWIND

33645 United Ave. Pueblo, CO 81001, U.S.A.
 Customer Service: **866.754.2275**
 24 Hour Order Fax: **866.754.3955**
 Order E-mail: **sales@westwindwood.net**

ORDER FORM for Doors and Drawer Fronts

Quote Only

Date:

Job Name:

PO #:

Westwind Wood Office Use Only

Order Date:

Completion Date:

Job #:

Please Acknowledge Order By: Fax E-mail Mail

Company Name:		Contact Person:	
Mailing Address:		Phone #:	Fax #:
City/State/Zip:		E-mail:	
Shipping Address:			

Finish Detail	Vibrated <input type="checkbox"/> No Vibrate <input type="checkbox"/>	Five Piece Drawer Front Grain	Vertical <input type="checkbox"/>
---------------	---	-------------------------------	-----------------------------------

Wood Species: _____ Grade: Paint Select Natural Rustic Heritage

Door Style:	Custom Frame Size:	12						
Frame Profile:	Applied Moulding: AP _____	13						
Panel Profile:	Accent Plugs:	14						
Edge Profile:	Radius Corners:	15						
Panel Bead Profile: BP _____	Inches On Center:	16						
Hinge Bore:	Custom Edge Distance: _____ mm	17						
BH <input type="checkbox"/> GH <input type="checkbox"/> EH <input type="checkbox"/> KH <input type="checkbox"/>		18						
Glass Doors: FOXP <input type="checkbox"/> Rout Only <input type="checkbox"/>		19						
FOXP Moulding: Yes <input type="checkbox"/> No <input type="checkbox"/>		20						
Finger Pulls: 4" <input type="checkbox"/> FL <input type="checkbox"/>		21						
Item Codes	DR = Doors DF = Drawer Front - Slab	22						
Panels = PN GL = Glass 5D = Drawer Front - 5 pc.		23						
Item Code	Qty.	Exact Width	Exact Height	Special Instructions				24
1								25
2								26
3								27
4								28
5								29
6								30
7								31
8								32
9								33
10								34
11								35

Special Job Instructions:

Use Best Shipping Method
 Preferred Shipping Method: Parcel
 Our Truck Truckline Will Call

WESTWIND

33645 United Ave. Pueblo, CO 81001, U.S.A.
 Customer Service: **866.754.2275**
 24 Hour Order Fax: **866.754.3955**
 Order E-mail: **sales@westwindwood.net**

ORDER FORM for Doors and Drawer Fronts

Quote Only

Date:

Job Name:

PO #:

Westwind Wood Office Use Only

Order Date:

Completion Date:

Job #:

Please Acknowledge Order By: Fax E-mail Mail

Company Name:		Contact Person:	
Mailing Address:		Phone #:	Fax #:
City/State/Zip:		E-mail:	
Shipping Address:			

Finish Detail	Vibrated <input type="checkbox"/> No Vibrate <input type="checkbox"/>	Five Piece Drawer Front Grain	Vertical <input type="checkbox"/>
---------------	---	-------------------------------	-----------------------------------

Wood Species: _____ Grade: Paint Select Natural Rustic Heritage

Door Style:	Custom Frame Size:	12						
Frame Profile:	Applied Moulding: AP _____	13						
Panel Profile:	Accent Plugs:	14						
Edge Profile:	Radius Corners:	15						
Panel Bead Profile: BP _____	Inches On Center:	16						
Hinge Bore:	Custom Edge Distance: _____ mm	17						
BH <input type="checkbox"/> GH <input type="checkbox"/> EH <input type="checkbox"/> KH <input type="checkbox"/>		18						
Glass Doors: FOXP <input type="checkbox"/> Rout Only <input type="checkbox"/>		19						
FOXP Moulding: Yes <input type="checkbox"/> No <input type="checkbox"/>		20						
Finger Pulls: 4" <input type="checkbox"/> FL <input type="checkbox"/>		21						
Item Codes	DR = Doors DF = Drawer Front - Slab	22						
Panels = PN GL = Glass 5D = Drawer Front - 5 pc.		23						
Item Code	Qty.	Exact Width	Exact Height	Special Instructions				24
1								25
2								26
3								27
4								28
5								29
6								30
7								31
8								32
9								33
10								34
11								35

Special Job Instructions:	Use Best Shipping Method <input type="checkbox"/>
	Preferred Shipping Method: Parcel <input type="checkbox"/>
	Our Truck <input type="checkbox"/> Truckline <input type="checkbox"/> Will Call <input type="checkbox"/>

WESTWIND

33645 United Ave. Pueblo, CO 81001, U.S.A.
 Customer Service: **866.754.2275**
 24 Hour Order Fax: **866.754.3955**
 Order E-mail: **sales@westwindwood.net**

ORDER FORM for Drawer Boxes

Quote Only

Date:

Job Name:

PO #:

Westwind Wood Office Use Only

Order Date:

Completion Date:

Job #:

Please Acknowledge Order By: Fax E-mail Mail

Company Name:		Contact Person:	
Mailing Address:		Phone #:	Fax #:
City/State/Zip:		E-mail:	
Shipping Address:			

Include Blum Drawer Slides <input type="checkbox"/>	Wood Species:	$\frac{5}{8}$ " Sides: <input type="checkbox"/>	Please indicate desired options in the special instructions column on this order form. - Scoop - Pullout Tabs - Exposed Front - Radius Corners - Etc.
		$\frac{1}{2}$ " Sides (20% Up-charge) <input type="checkbox"/>	
		$\frac{3}{4}$ " Sides (20% Up-charge) <input type="checkbox"/>	
All drawer boxes will be assembled and finished unless marked otherwise. Unassembled <input type="checkbox"/> Unfinished <input type="checkbox"/>	Wood Species:	$\frac{1}{4}$ " Bottoms: <input type="checkbox"/>	
		$\frac{1}{2}$ " Bottoms (20% Up-charge) <input type="checkbox"/>	
	Upset Bottoms: $\frac{1}{2}$ " <input type="checkbox"/>	$\frac{1}{4}$ " <input type="checkbox"/>	
	1 $\frac{3}{4}$ " Notch & Bore <input type="checkbox"/> Custom Notch Width:		
	Undermount Clips:		

Qty.	Exact Width	Exact Depth	Exact Height	Special Instructions	Qty.	Exact Width	Exact Depth	Exact Height	Special Instructions
1					18				
2					19				
3					20				
4					21				
5					22				
6					23				
7					24				
8					25				
9					26				
10					27				
11					28				
12					29				
13					30				
14					31				
15					32				
16					33				
17					34				

Special Job Instructions:

Use Best Shipping Method
 Preferred Shipping Method: Parcel
 Our Truck Truckline Will Call

WESTWIND

33645 United Ave. Pueblo, CO 81001, U.S.A.
 Customer Service: **866.754.2275**
 24 Hour Order Fax: **866.754.3955**
 Order E-mail: **sales@westwindwood.net**

ORDER FORM for Drawer Boxes

Quote Only

Date:

Job Name:

PO #:

Westwind Wood Office Use Only

Order Date:

Completion Date:

Job #:

Please Acknowledge Order By: Fax E-mail Mail

Company Name:		Contact Person:	
Mailing Address:		Phone #:	Fax #:
City/State/Zip:		E-mail:	
Shipping Address:			

Include Blum Drawer Slides <input type="checkbox"/>	Wood Species:	$\frac{5}{8}$ " Sides: <input type="checkbox"/>	Please indicate desired options in the special instructions column on this order form. - Scoop - Pullout Tabs - Exposed Front - Radius Corners - Etc.
		$\frac{1}{2}$ " Sides (20% Up-charge) <input type="checkbox"/>	
		$\frac{3}{4}$ " Sides (20% Up-charge) <input type="checkbox"/>	
All drawer boxes will be assembled and finished unless marked otherwise. Unassembled <input type="checkbox"/> Unfinished <input type="checkbox"/>	Wood Species:	$\frac{1}{4}$ " Bottoms: <input type="checkbox"/>	
		$\frac{1}{2}$ " Bottoms (20% Up-charge) <input type="checkbox"/>	
	Upset Bottoms: $\frac{1}{2}$ " <input type="checkbox"/>	$\frac{1}{4}$ " <input type="checkbox"/>	
	1 $\frac{3}{4}$ " Notch & Bore <input type="checkbox"/> Custom Notch Width:		
	Undermount Clips:		

Qty.	Exact Width	Exact Depth	Exact Height	Special Instructions	Qty.	Exact Width	Exact Depth	Exact Height	Special Instructions
1					18				
2					19				
3					20				
4					21				
5					22				
6					23				
7					24				
8					25				
9					26				
10					27				
11					28				
12					29				
13					30				
14					31				
15					32				
16					33				
17					34				

Special Job Instructions:

Use Best Shipping Method
 Preferred Shipping Method: Parcel
 Our Truck Truckline Will Call

Molding pricing can be most easily found on our online ordering system. Visit www.Westwindwood.net for more details.

8 Linear Feet is the minimum order quantity for any line item.

Molding has a minimum price of \$25 per line item (When ordering low cost per foot material you may find it to your advantage to order say 16LF or 24LF instead of 8 LF if it comes out to the same \$25 total price.)

We want our customers to be aware there is a volume discount built into our molding pricing.

Quantity	Discount
Over 99 Linear Feet	1%
Over 249 Linear Feet	3%
Over 499 Linear Feet	4%
Over 999 Linear Feet	5%

When purchasing molding by the Linear Foot please be aware that there will often be splits and imperfections due to both the natural wood characteristics and the molding process, in the extreme ends of each piece. Usually those imperfections will be contained in the outermost 2 inches at either end of the board; however on some occasions, those imperfections will extend further. However, they will never exceed 12 inches. Please keep this in mind when you are ordering. If you need a finished piece of material that is 96" long, do not plan to get 96" usable inches out of an 8' piece of lumber. Our pricing is based on producing molding in the lengths that we receive the raw materials. If you need to get a specific cut length of usable material, we can accommodate but the price will usually increase based on that constraint. In most situations it is optimal for you to order the raw material lengths you require and cut it to length yourself.

You can select the length of material for your molding order. However, please note that 8' and 10' lengths are the most widely available. Depending on the species, there may be other lengths readily available. If you are able, select 'Random' for the molding length. That will minimize possible delays to your order. A specific length will often extend production and delivery time frames.

Our standard list of wood species available for molding is as follows:

- | | | |
|------------------------|--------------------------|------------------------|
| Alder, Rustic | Hard Maple, Rustic | Red Oak |
| Alder, Select | Hard Maple, White | Sapele, Flat Sawn |
| Ash, White | Hickory, Rustic | Soft Maple, Paintgrade |
| Beech, Rustic European | Hickory | Soft Maple, White |
| Beech, European | Mahogany, African Ribbon | Soft Maple, Wormy |
| Birch, Natural Yellow | MDF | Walnut, Premium |
| Birch, White | Pine, Clear | Walnut, Rustic |
| Butternut | Pine, Knotty | White Oak, Quartered |
| Cherry, Rustic | Poplar | White Oak, Rift |
| Cherry | Red Oak, Quartered | White Oak, Rustic |
| Hard Maple, Birds-Eye | Red Oak, Rift | White Oak |
| Hard Maple, Paintgrade | Red Oak, Rustic | |

BASE PROFILES

Go West!

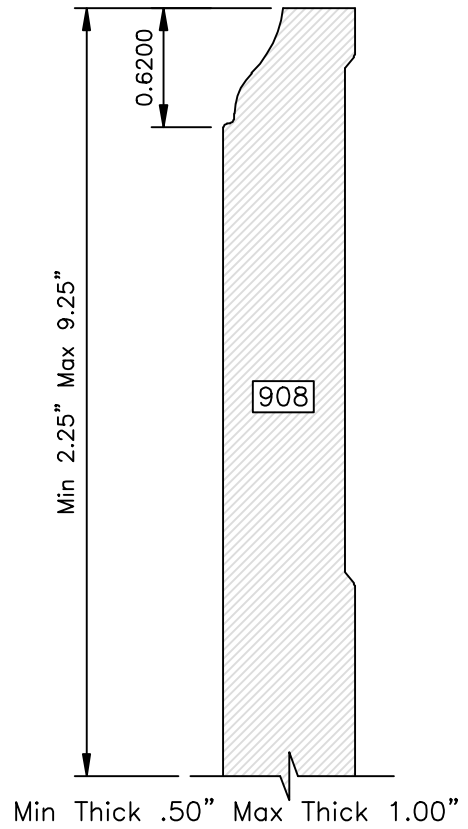
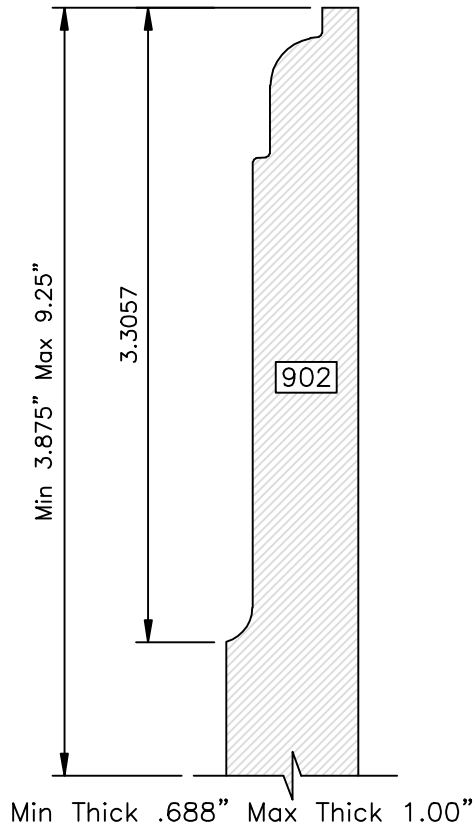

DRAWINGS ARE TO SCALE

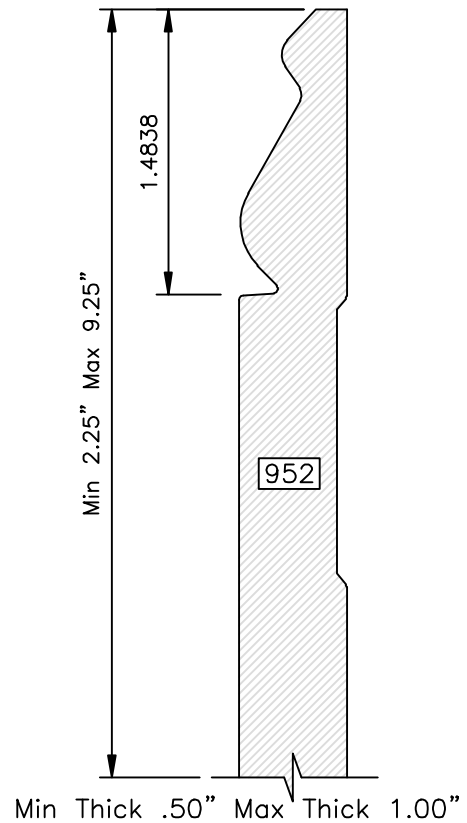
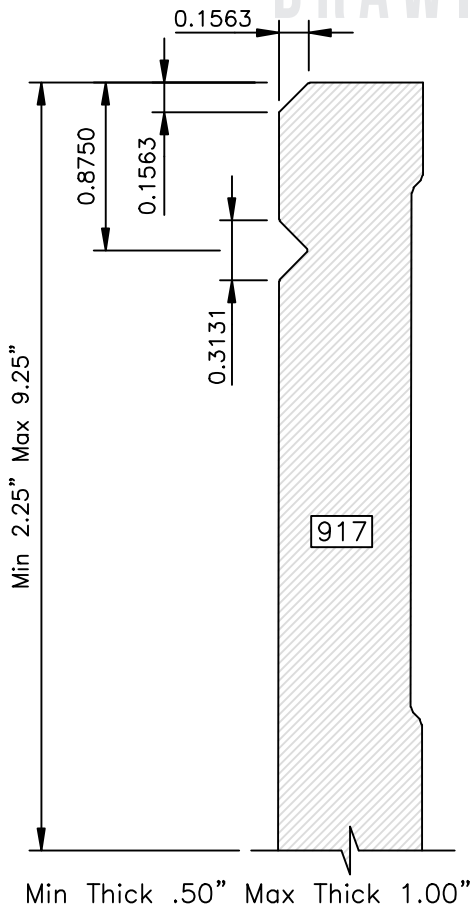

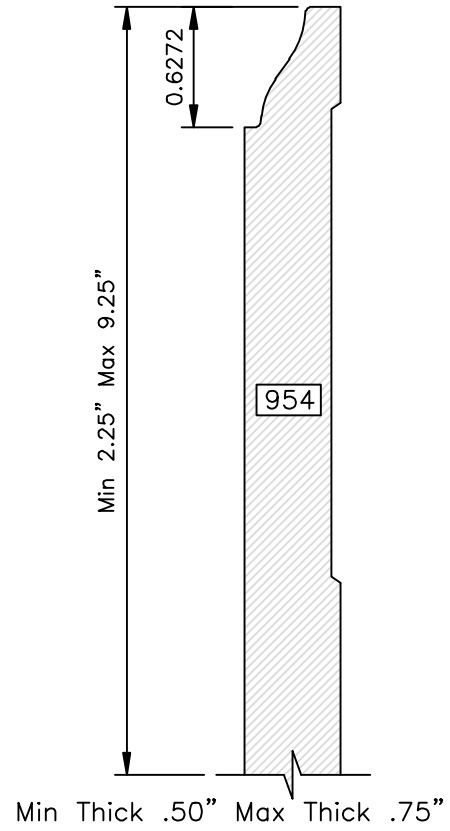
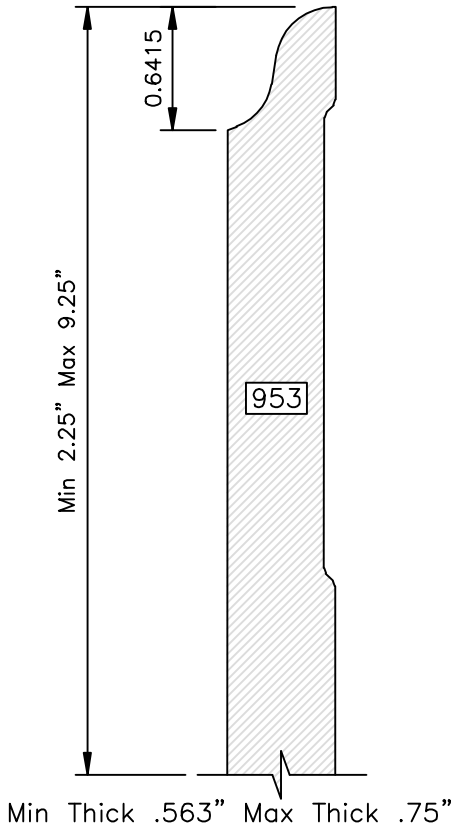

DRAWINGS ARE TO SCALE

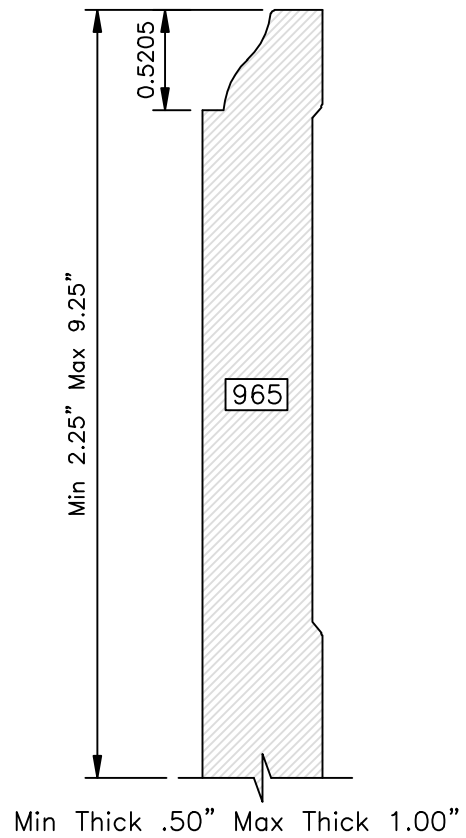
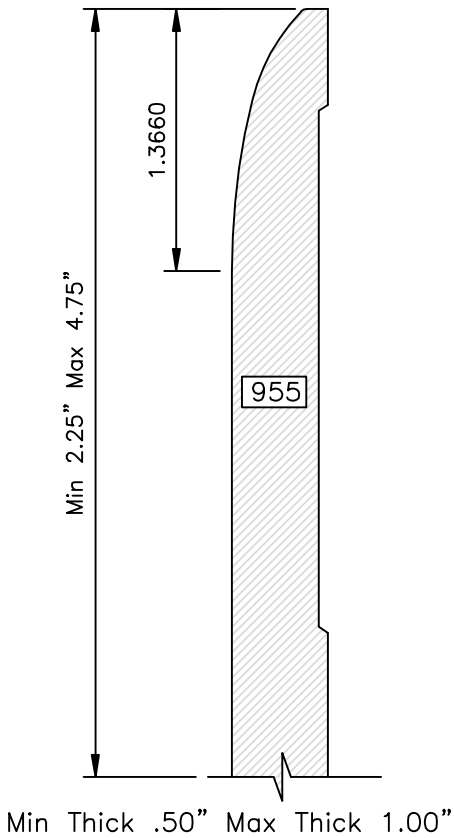

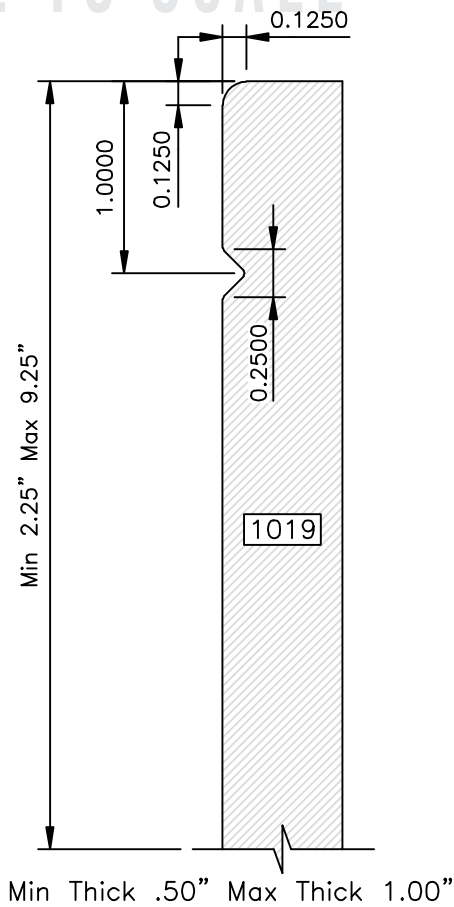
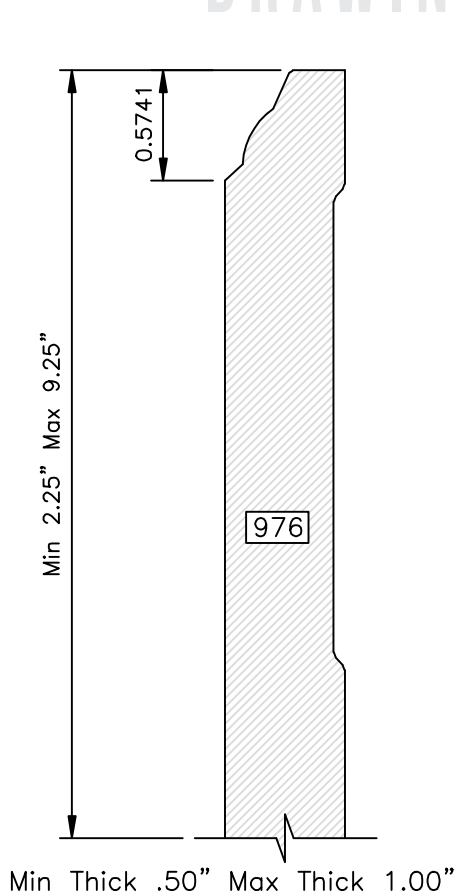
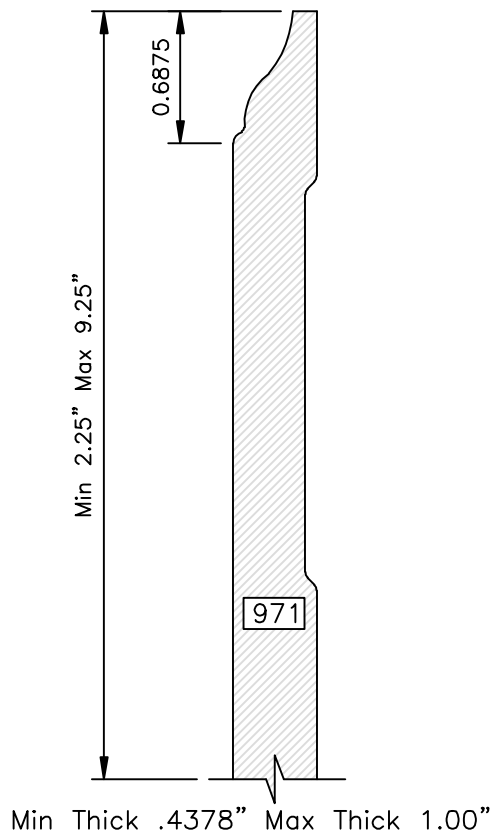
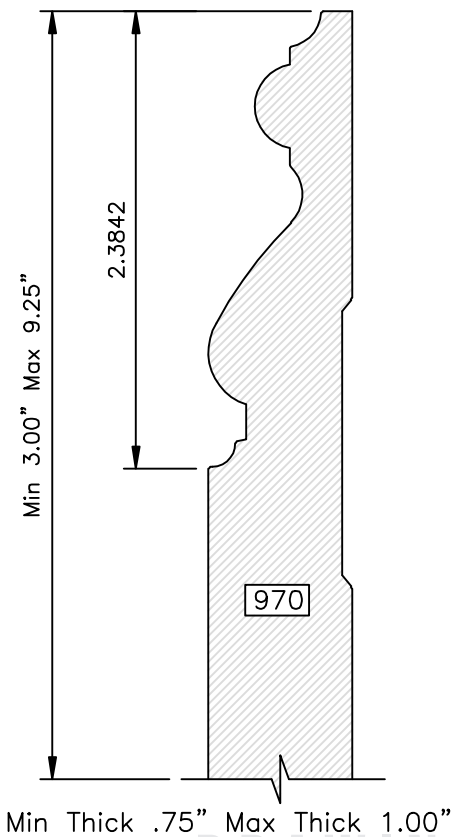

DRAWINGS ARE TO SCALE

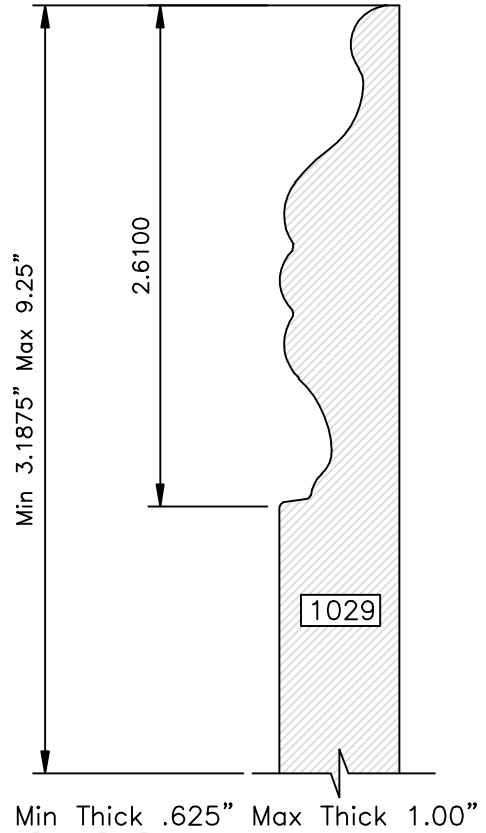
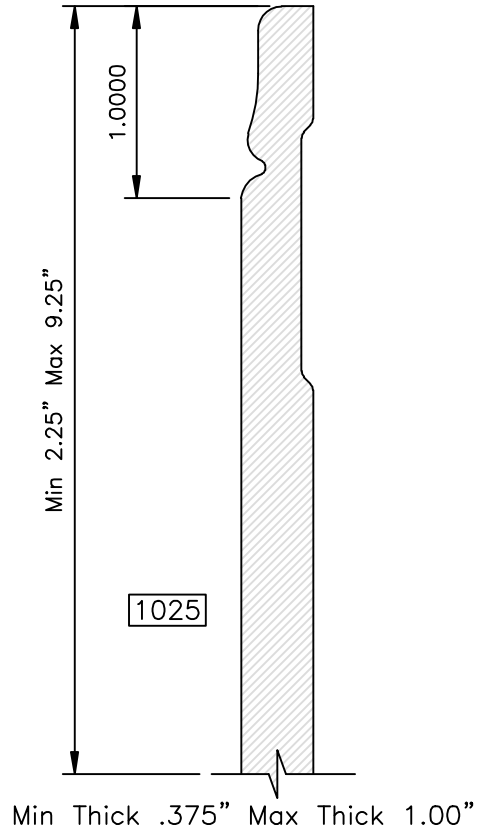

DRAWINGS ARE TO SCALE

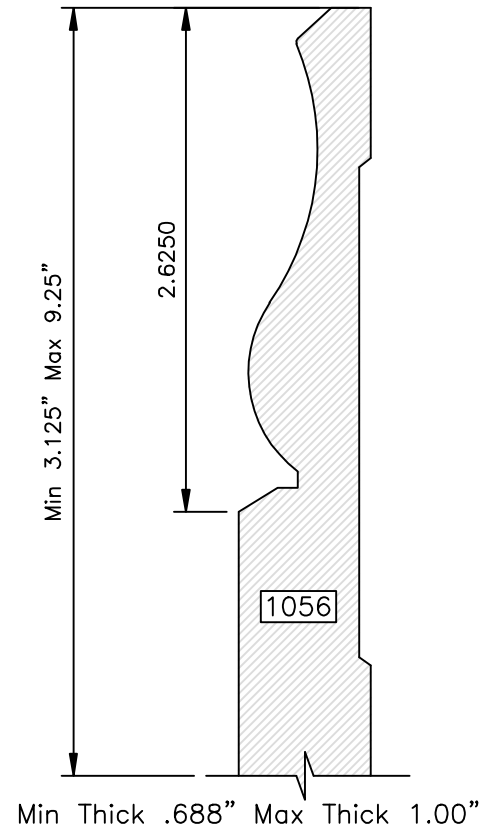
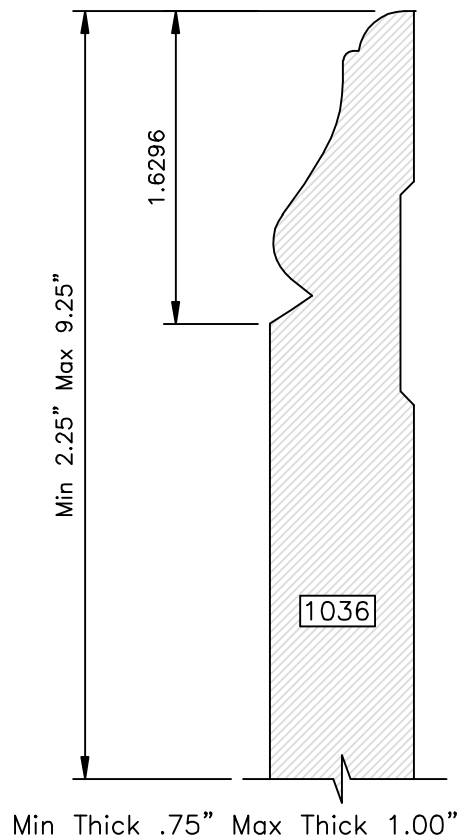

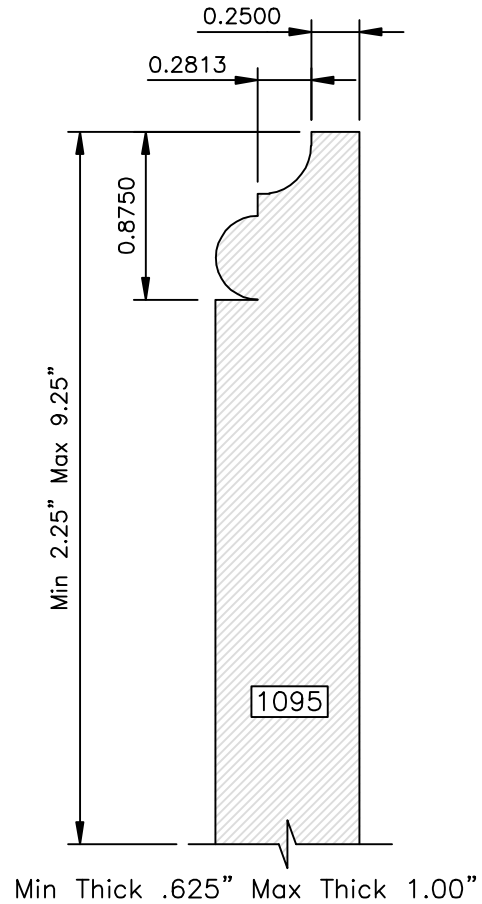
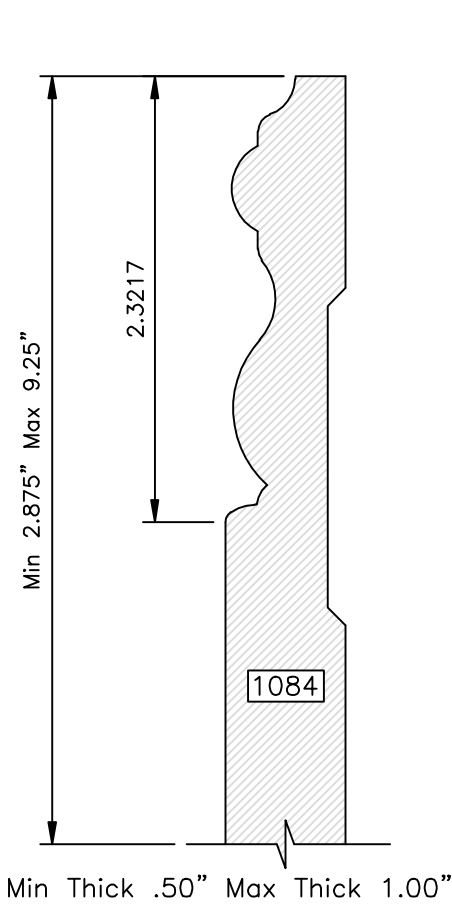

DRAWINGS ARE TO SCALE

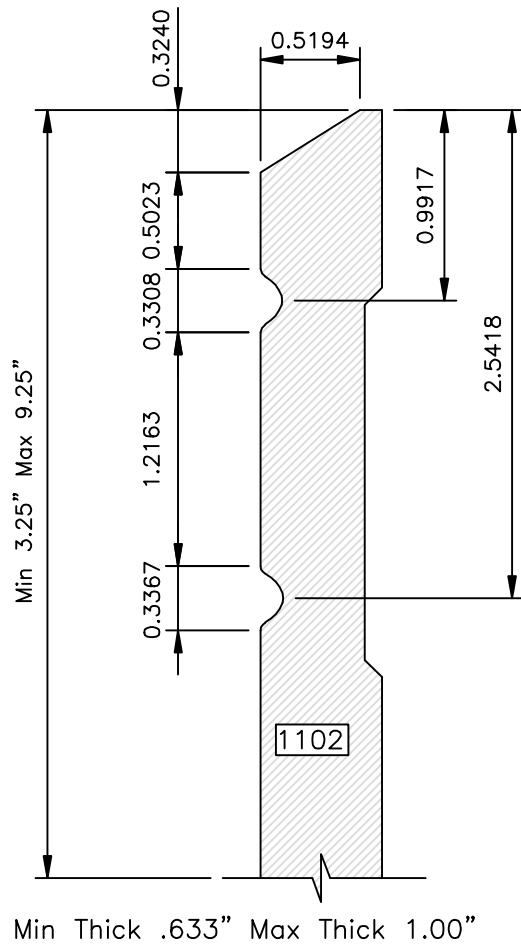
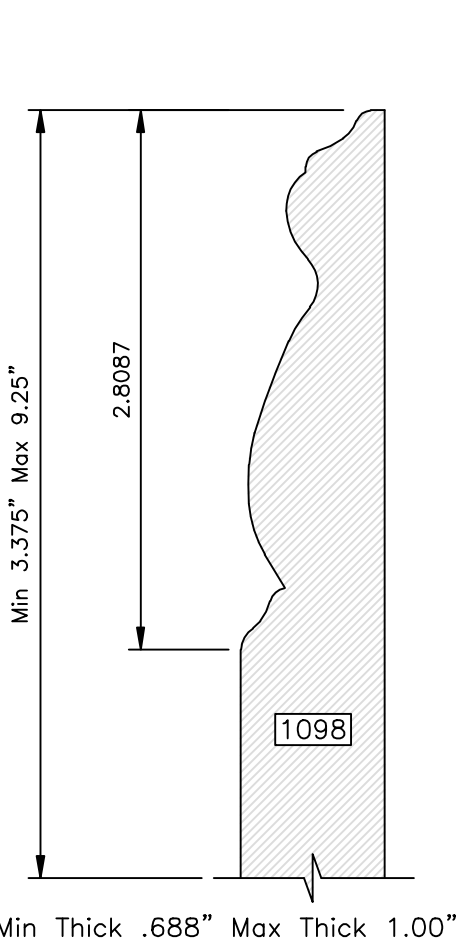

DRAWINGS ARE TO SCALE

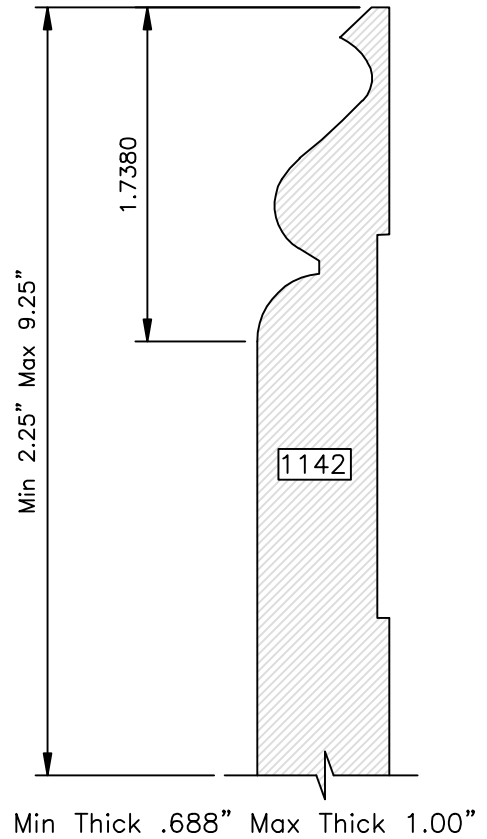
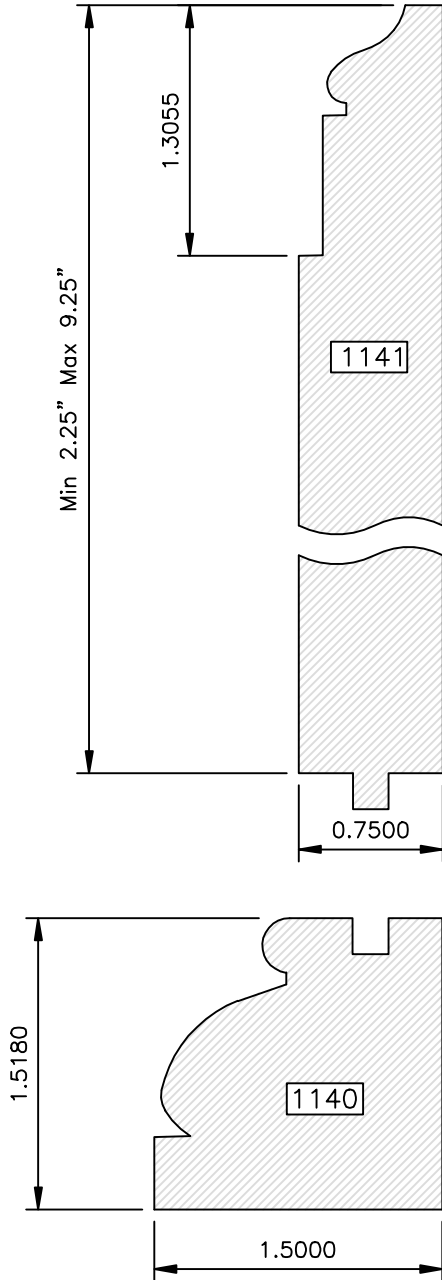

DRAWINGS ARE TO SCALE

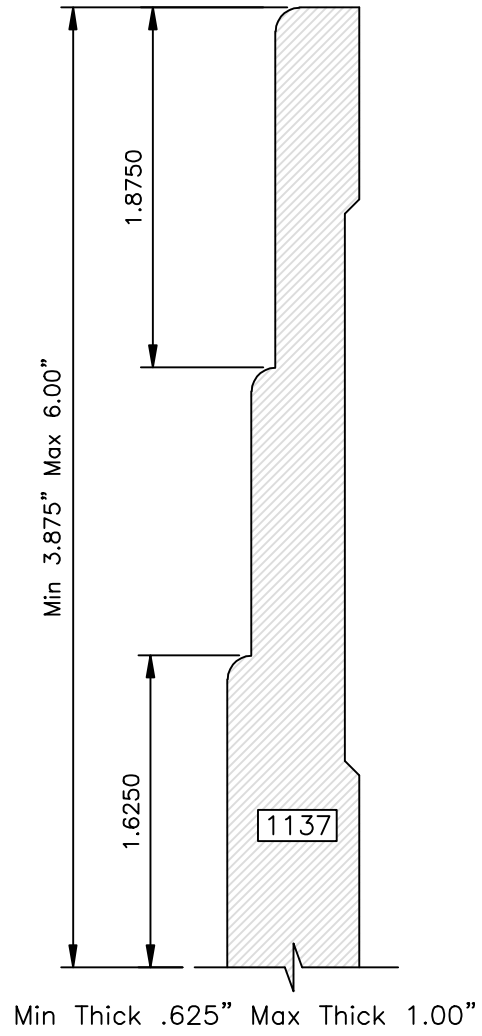
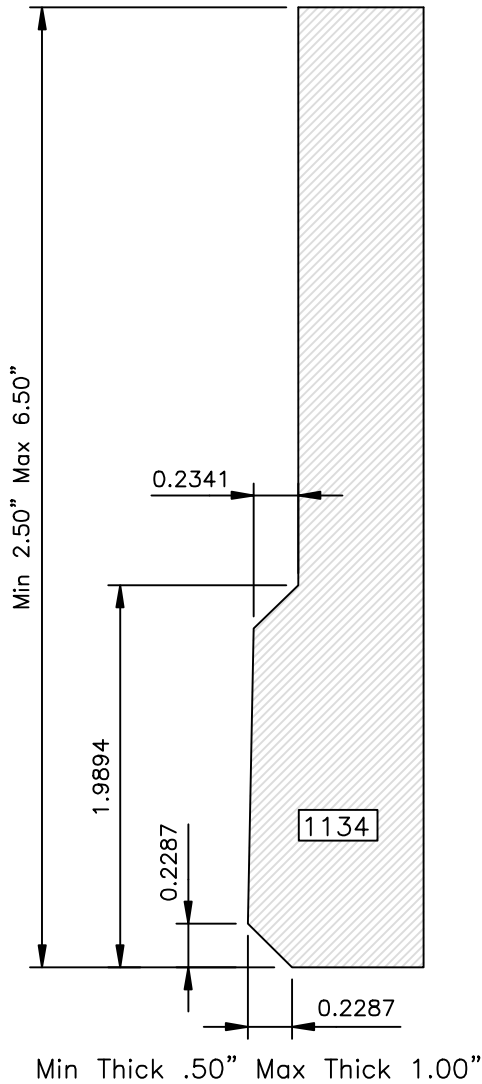

DRAWINGS ARE TO SCALE

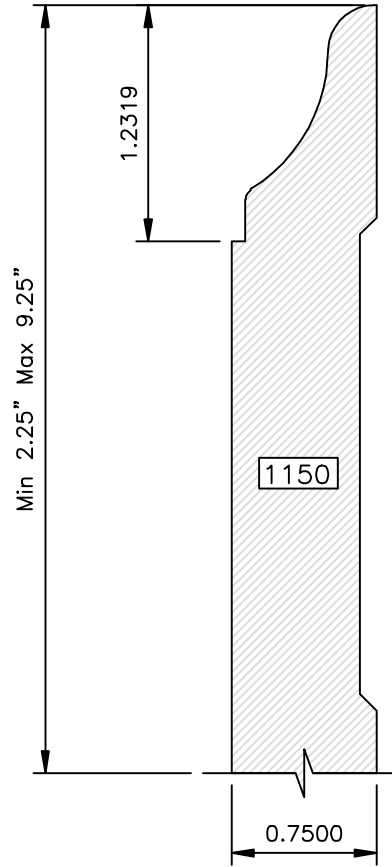
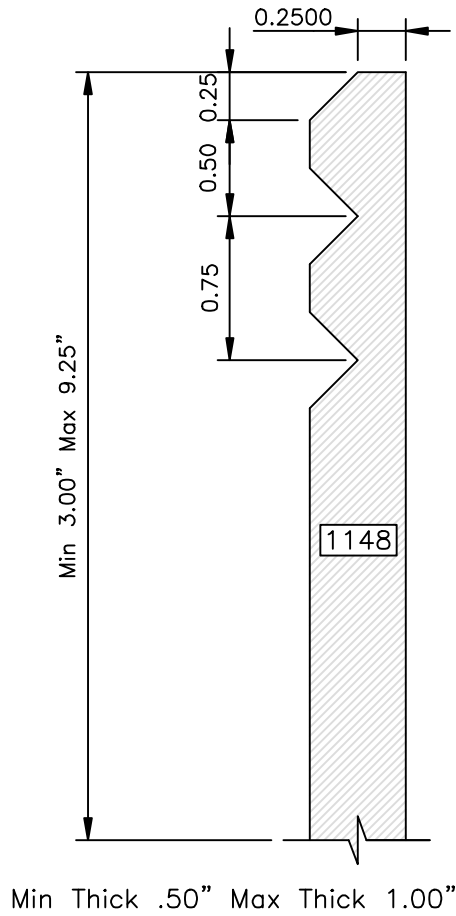

DRAWINGS ARE TO SCALE

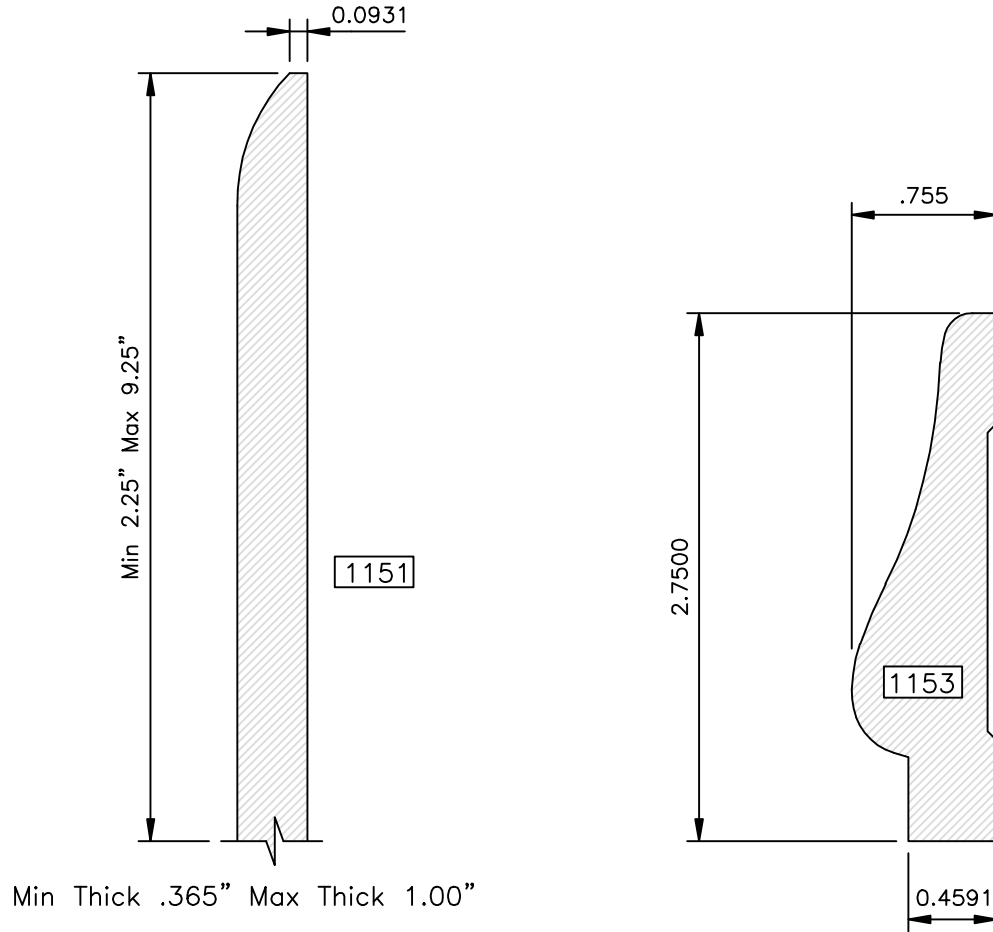

DRAWINGS ARE TO SCALE

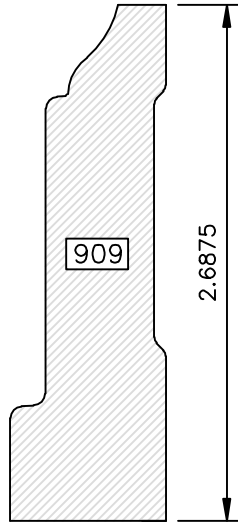

.8125" x 2.6875"

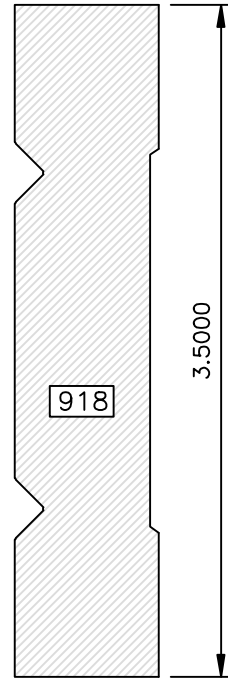

.750" x 3.50"

DRAWINGS ARE TO SCALE

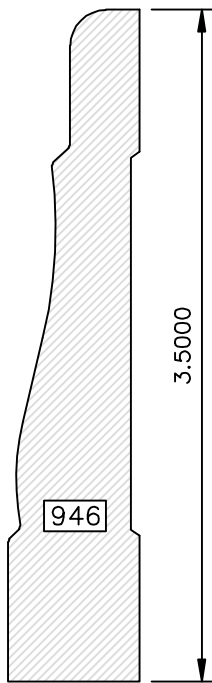

.6875" x 3.50"

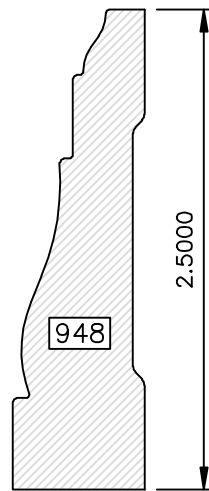

.6875" x 2.50"

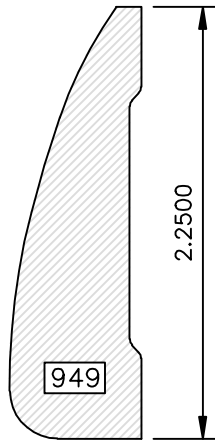

.6874" x 2.25"

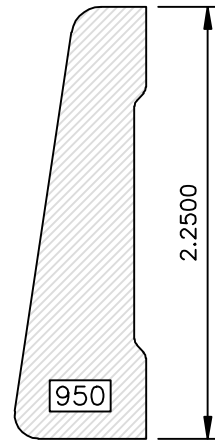

.6861" x 2.25"

DRAWINGS ARE TO SCALE

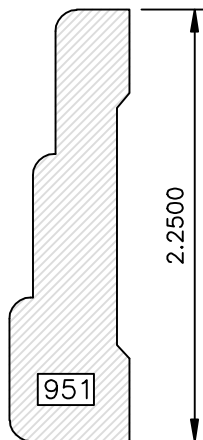

.6252" x 2.25"

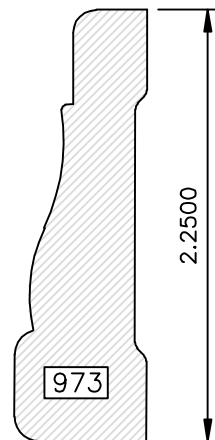

.6873" x 2.25"

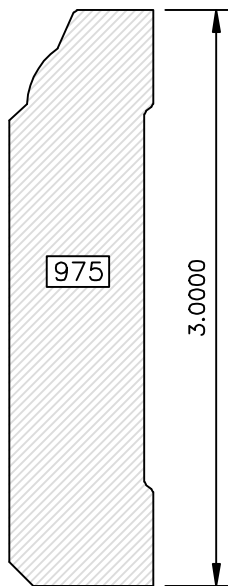

.750" x 3.00"

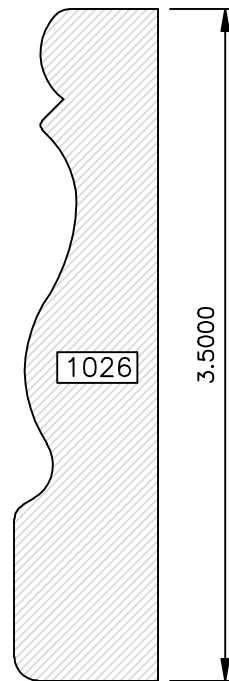

.750" x 3.50"

DRAWINGS ARE TO SCALE

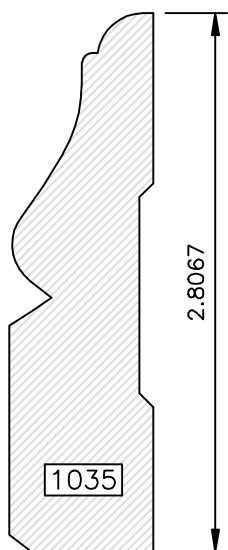

.750" x 2.8067"

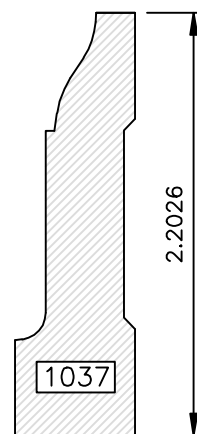

.625" x 2.2026"

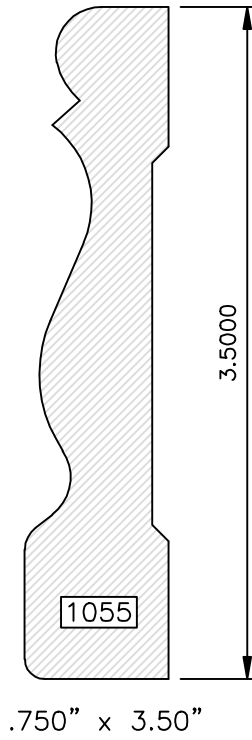
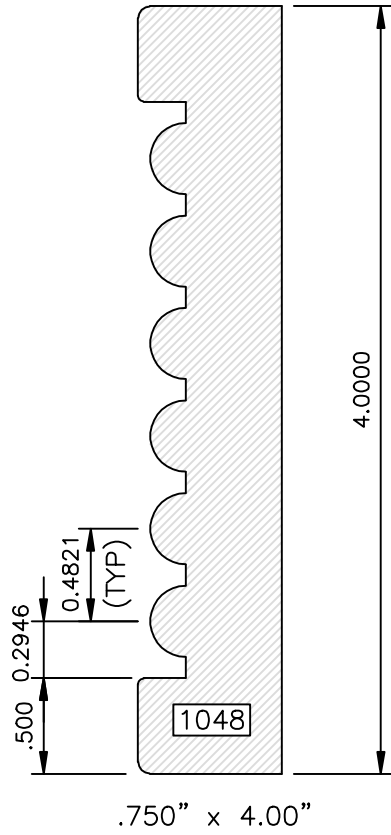

DRAWINGS ARE TO SCALE

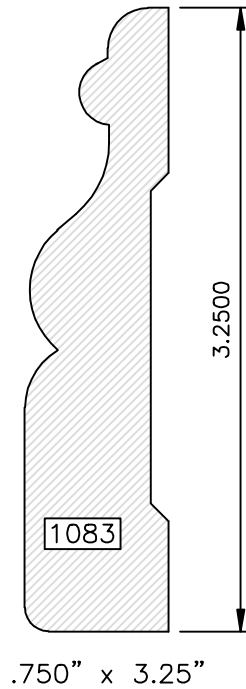
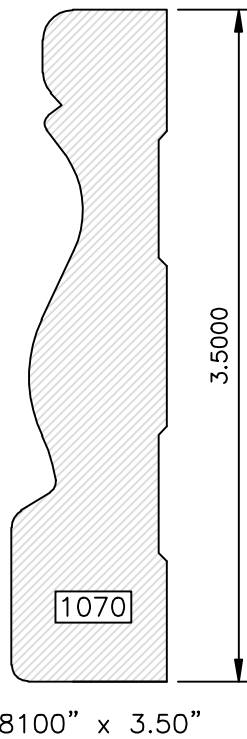

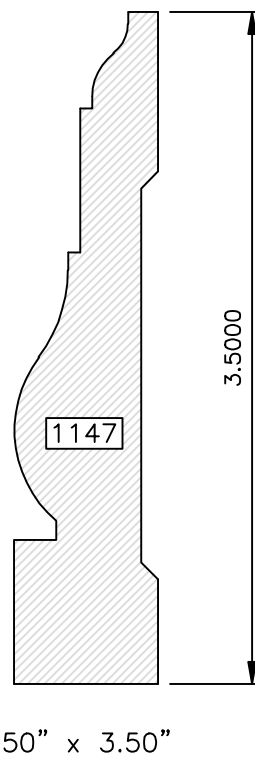
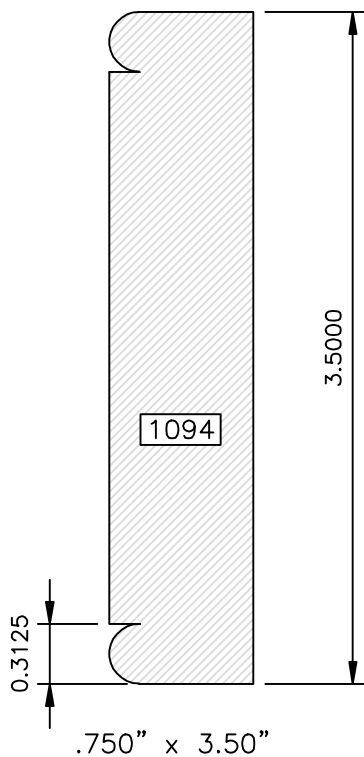

DRAWINGS ARE TO SCALE

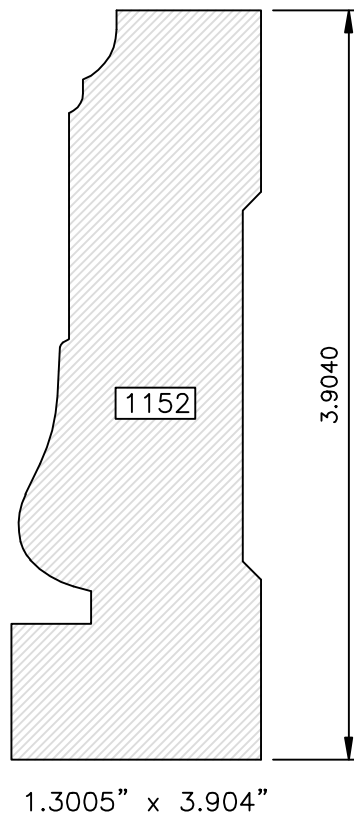
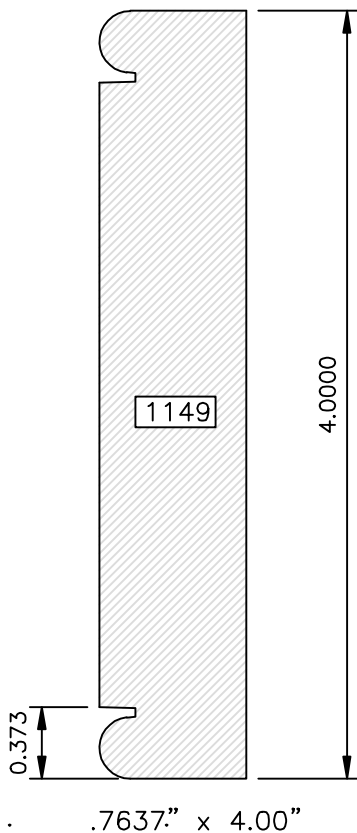



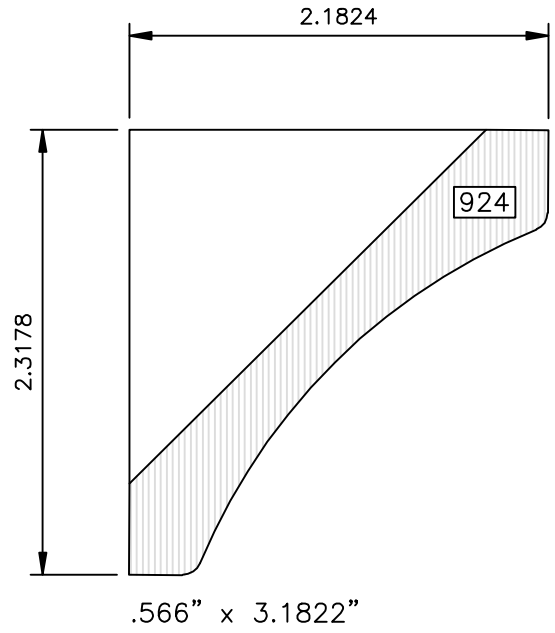
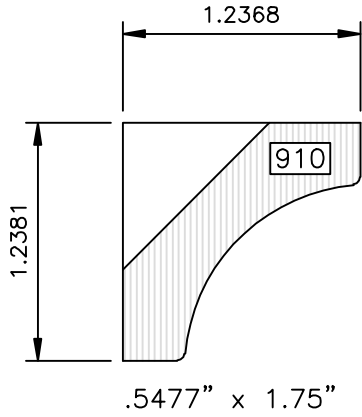

DRAWINGS ARE TO SCALE

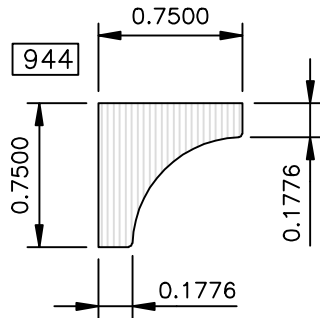
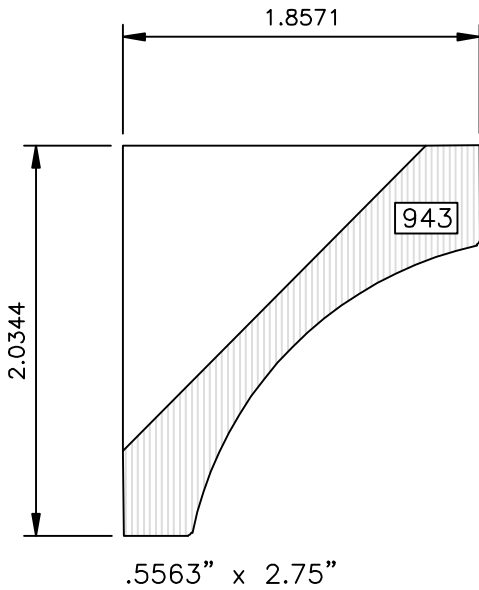

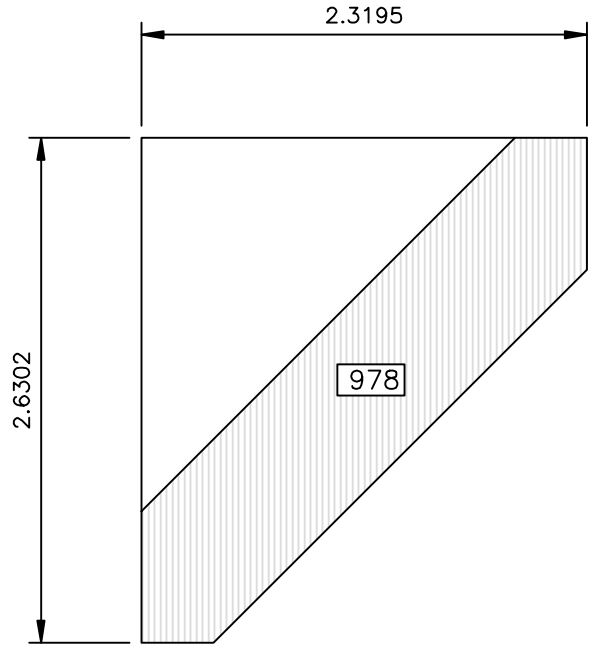
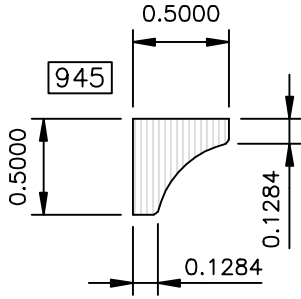

.750" x 3.50"

DRAWINGS ARE TO SCALE

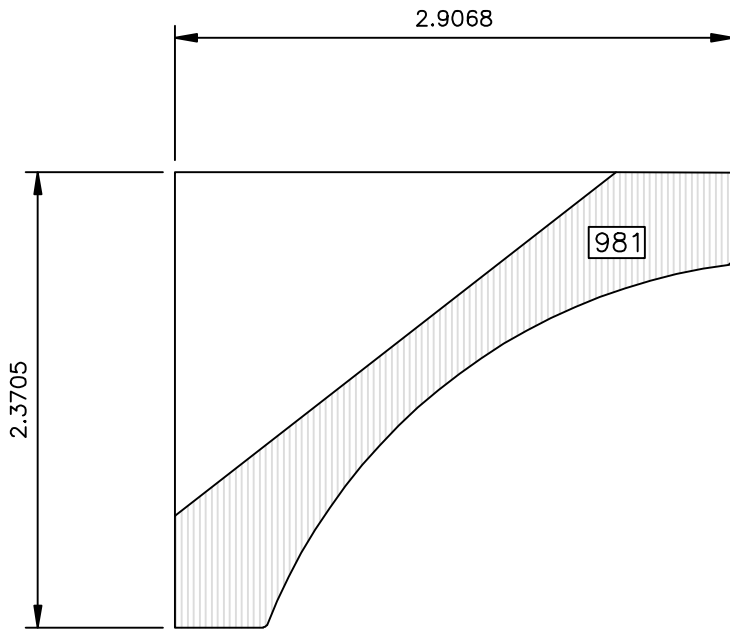

.750" x 3.75"

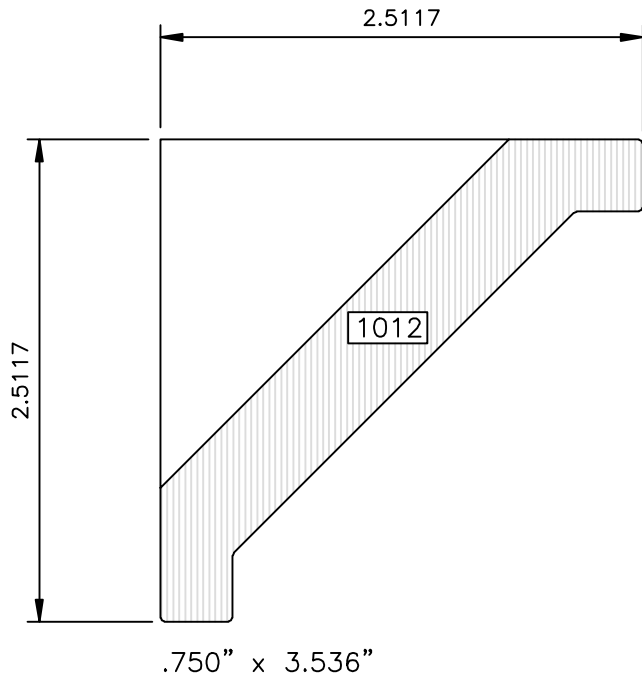

DRAWINGS ARE TO SCALE

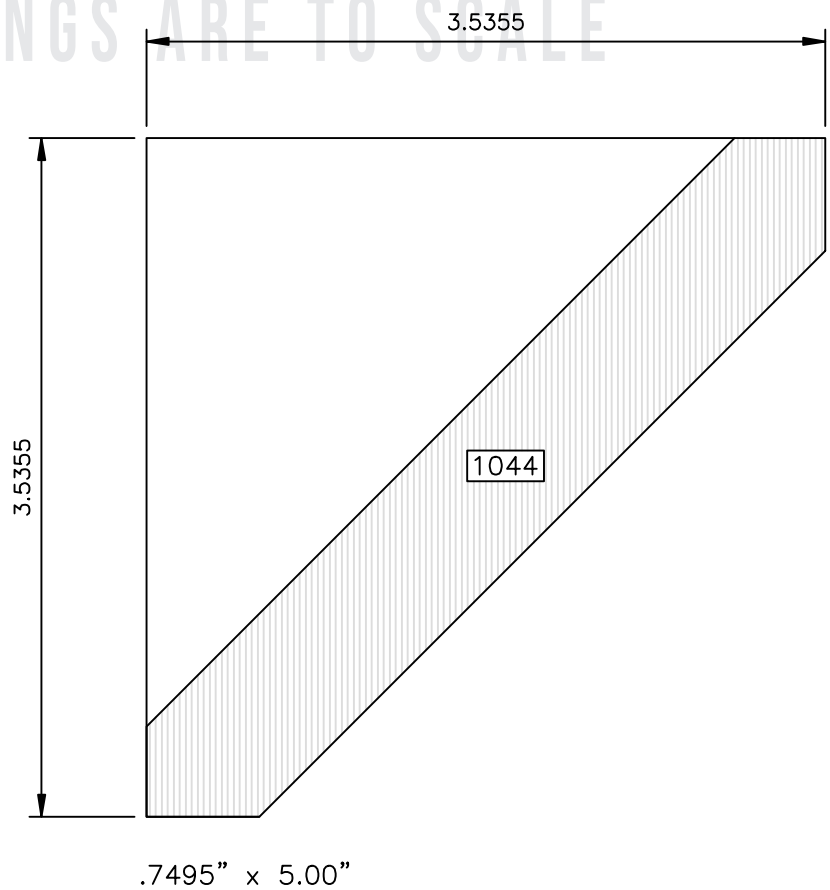

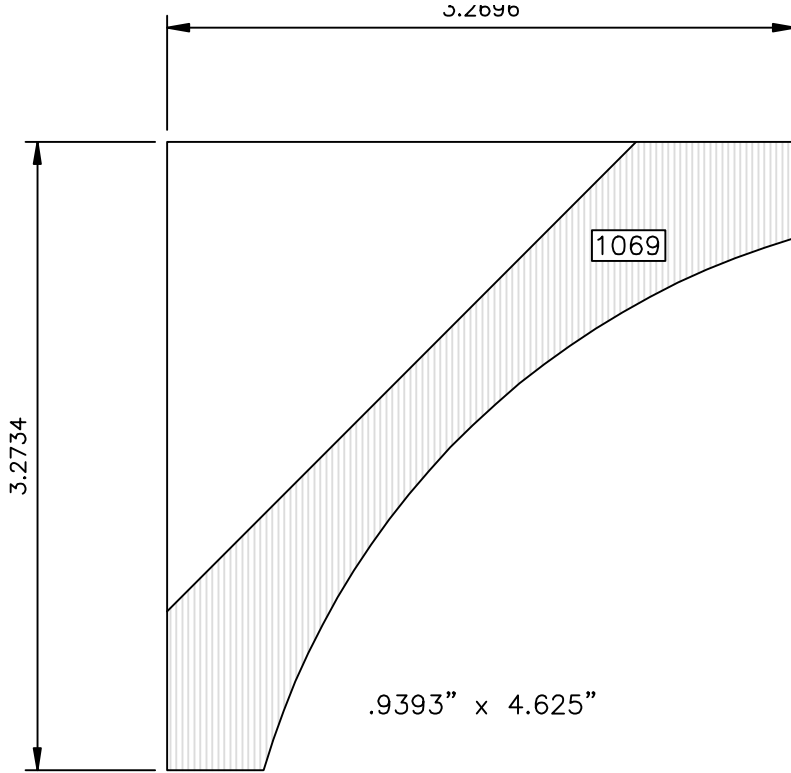

DRAWINGS ARE TO SCALE

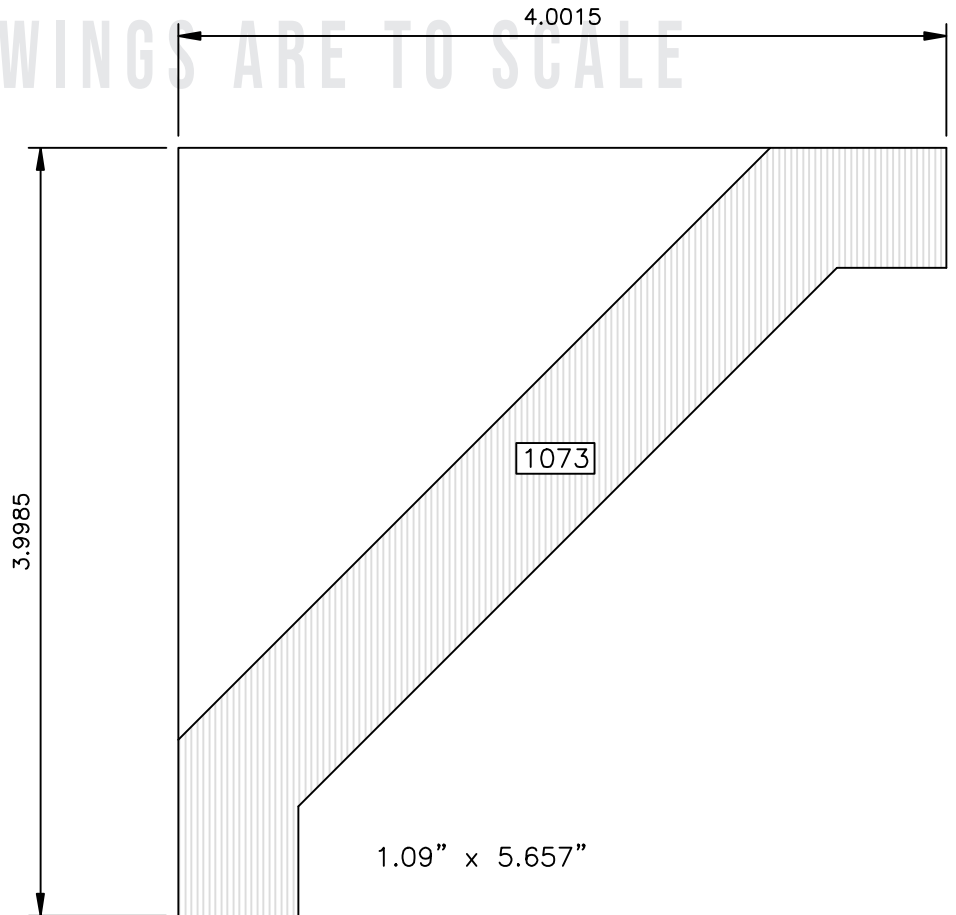

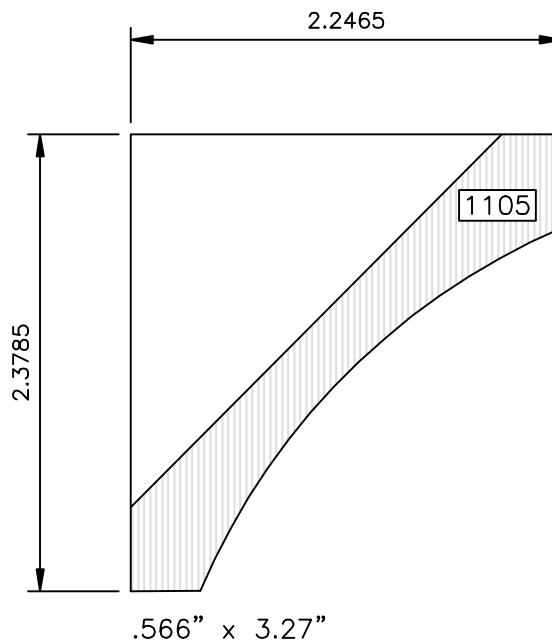
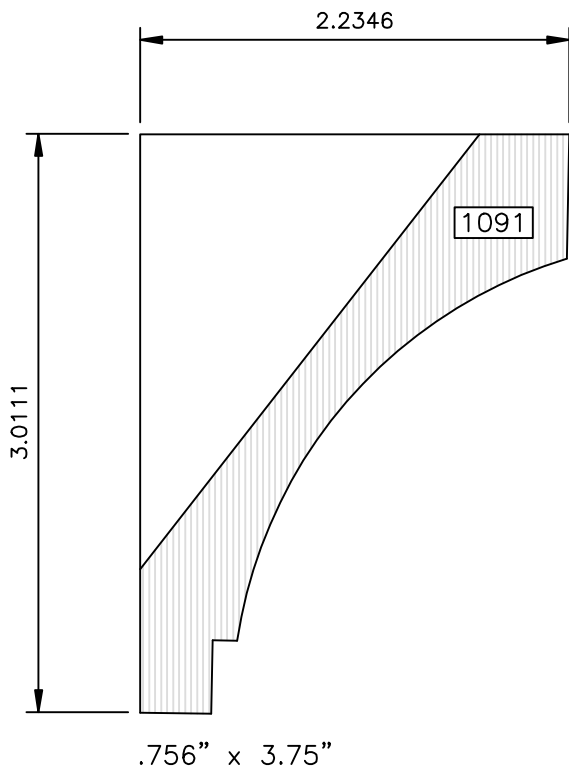

DRAWINGS ARE TO SCALE

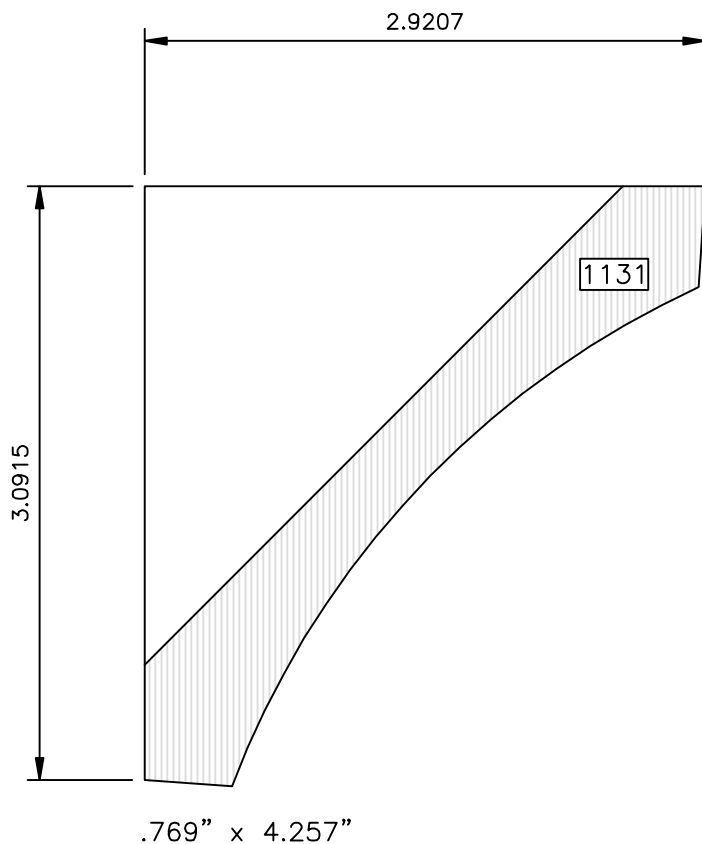
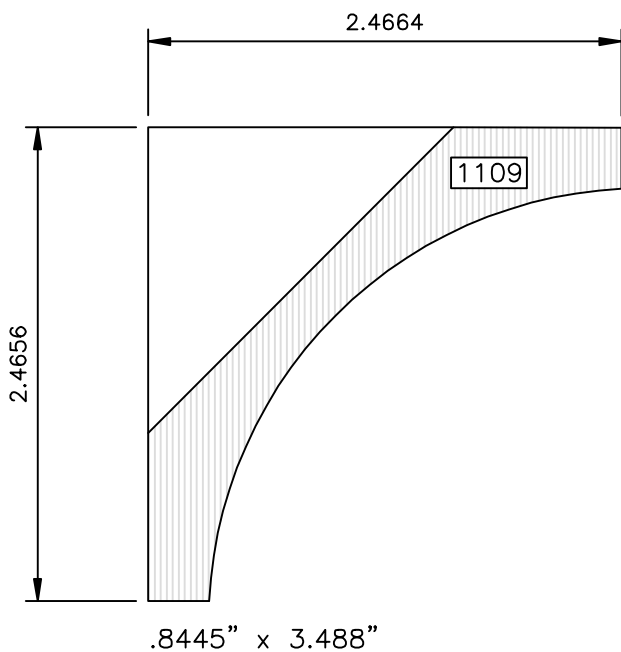

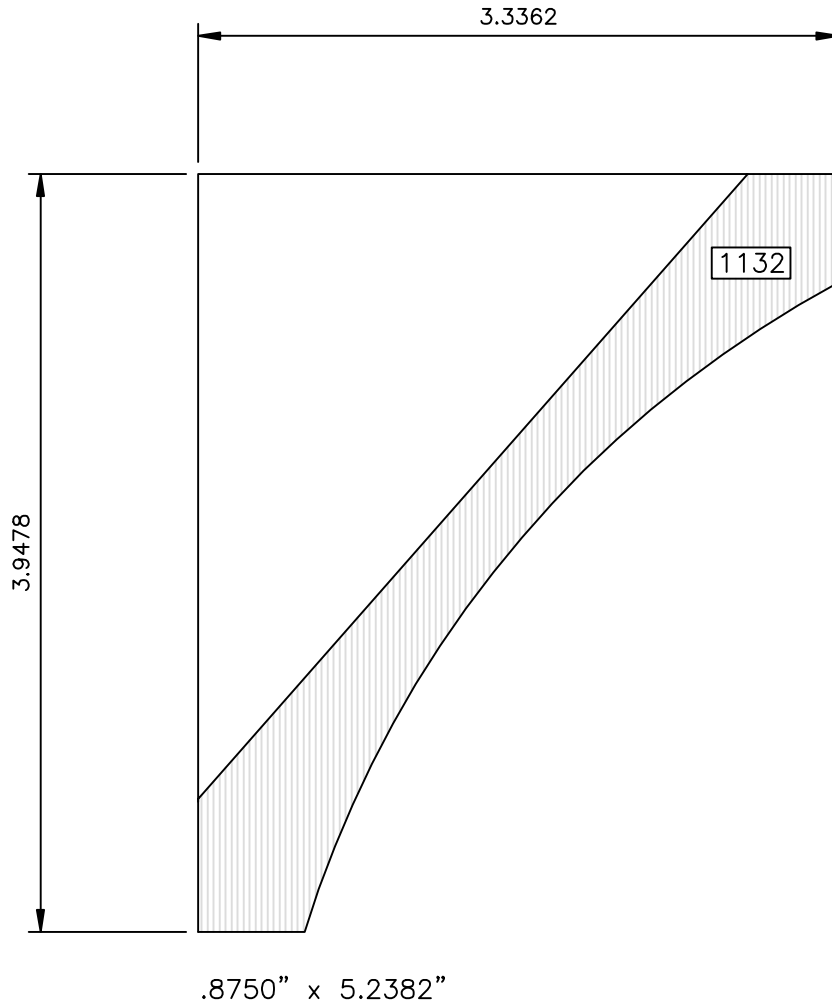

DRAWINGS ARE TO SCALE

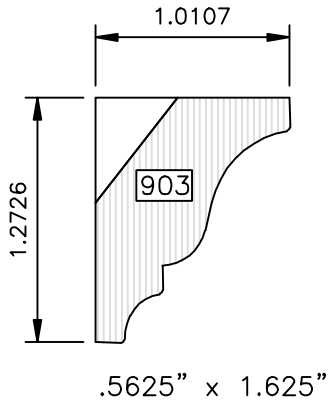

DRAWINGS ARE TO SCALE

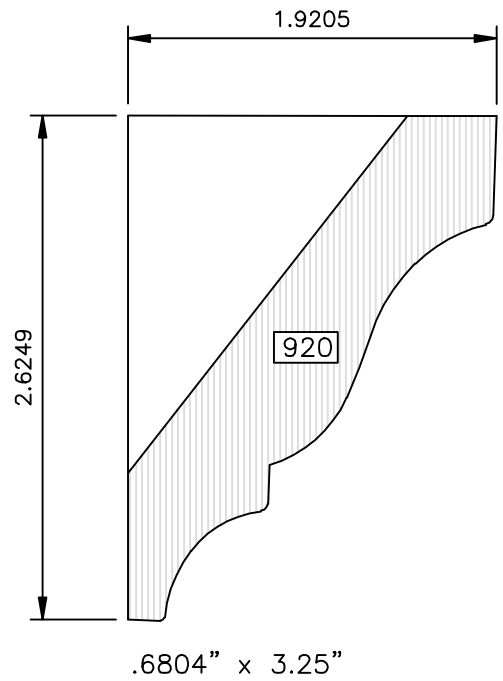
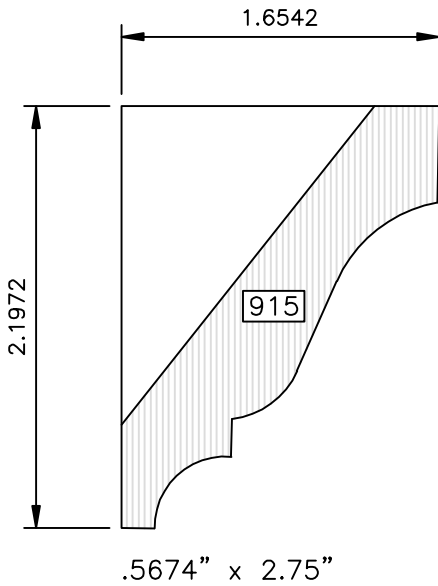

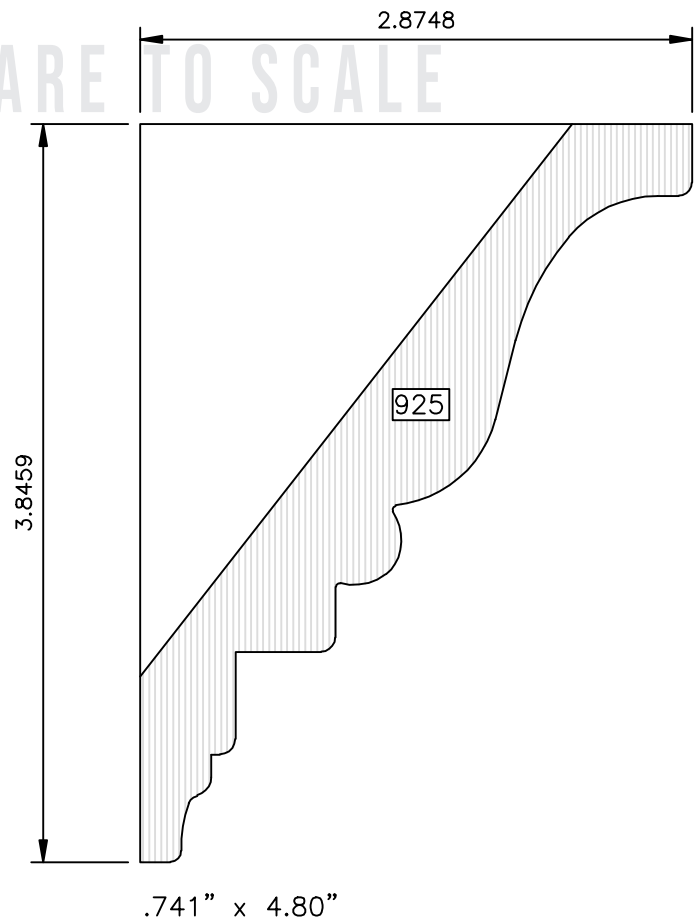
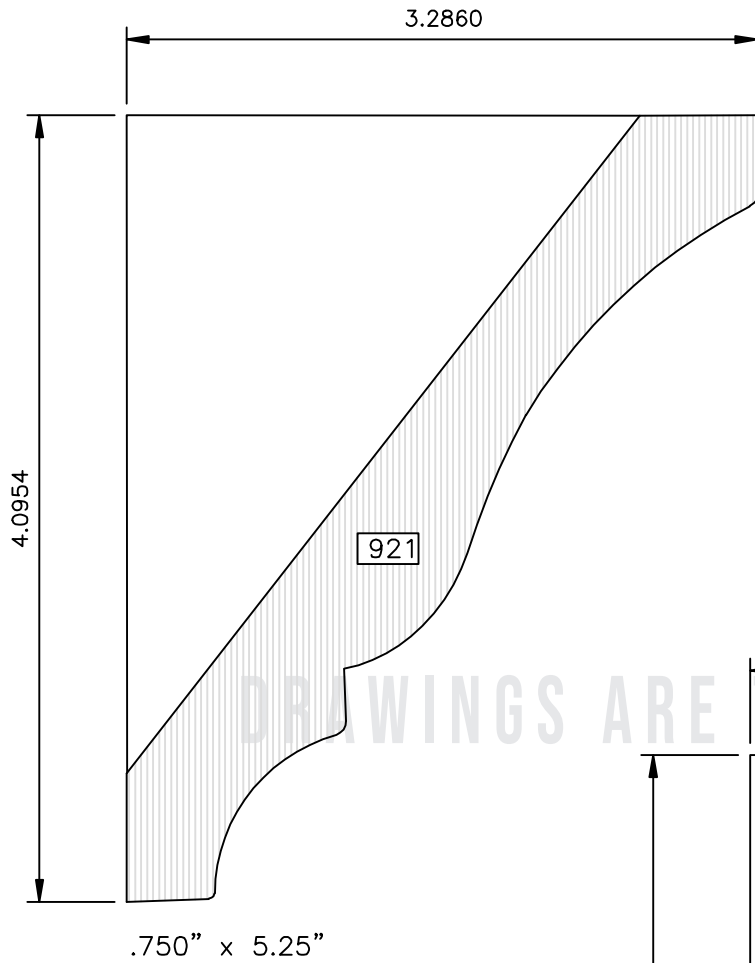

DRAWINGS ARE TO SCALE

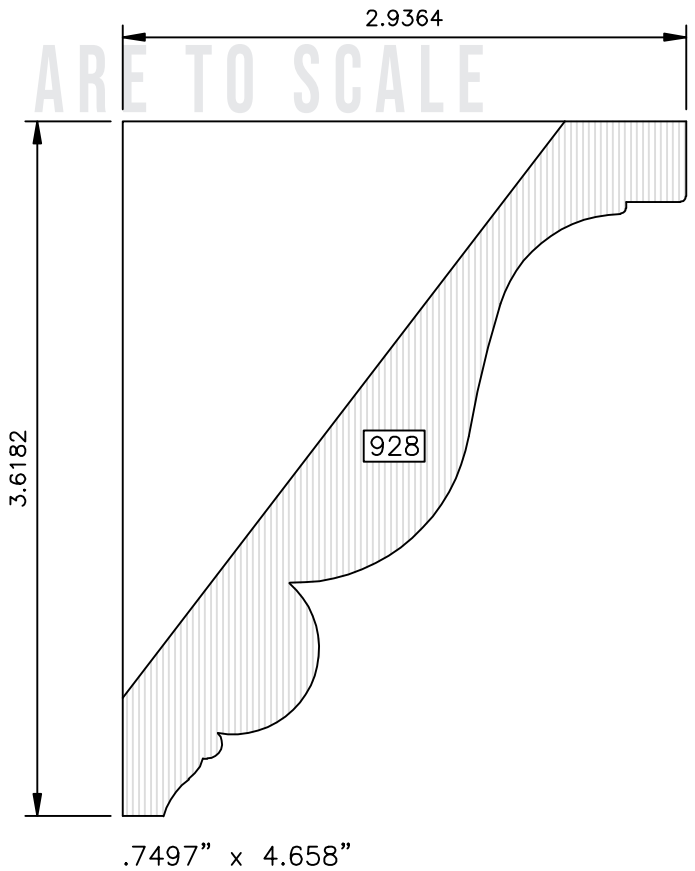
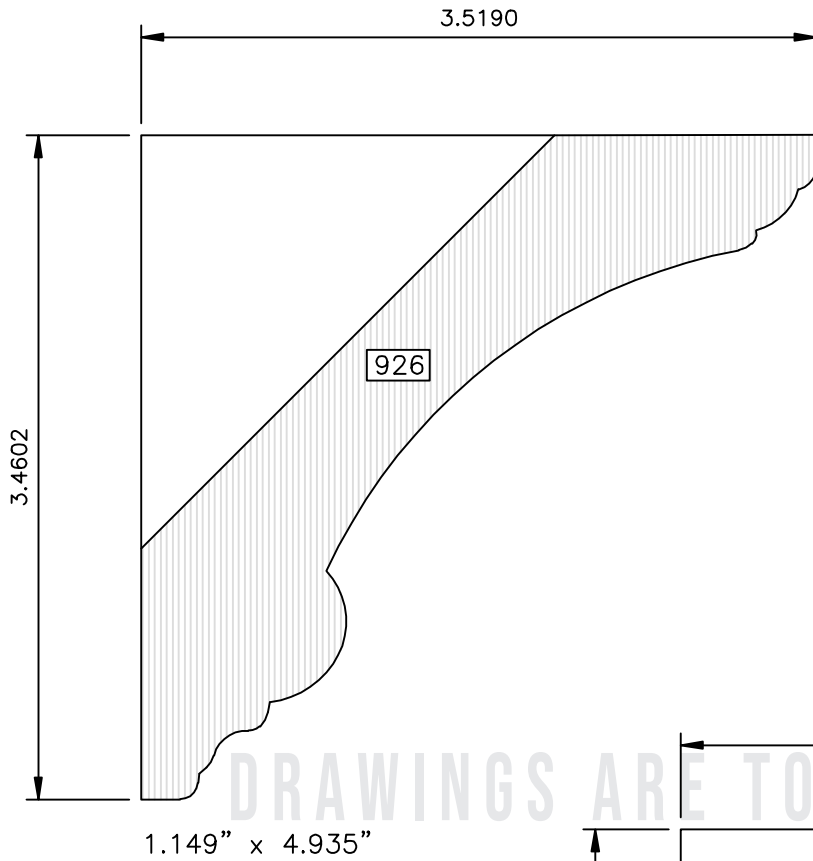

DRAWINGS ARE TO SCALE

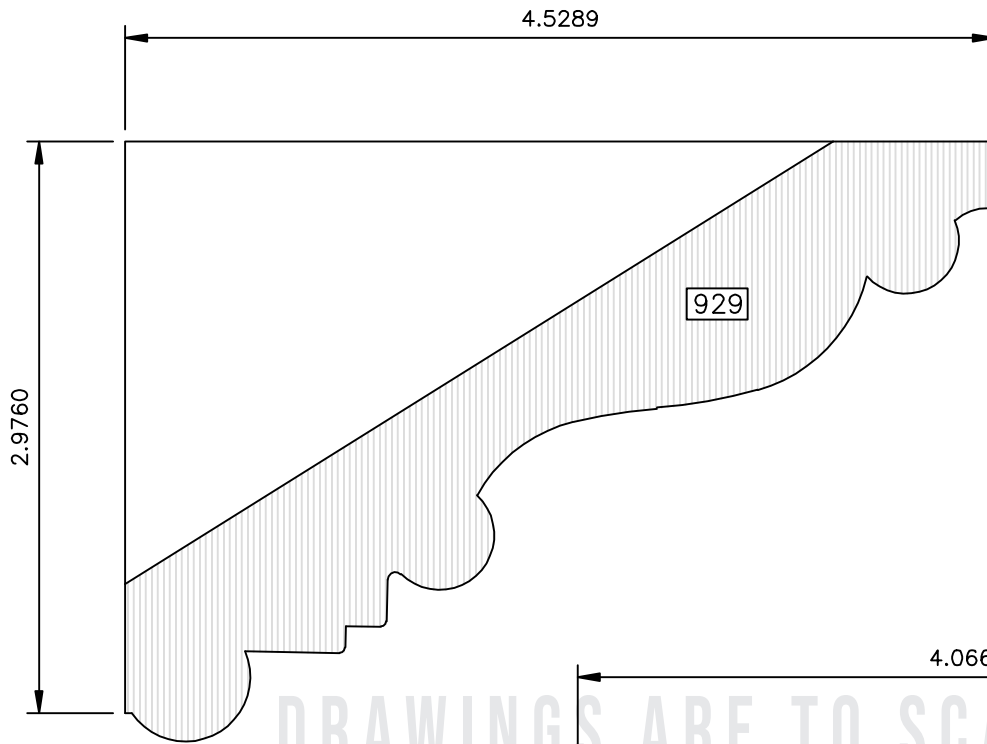

.9375" x 5.4198"

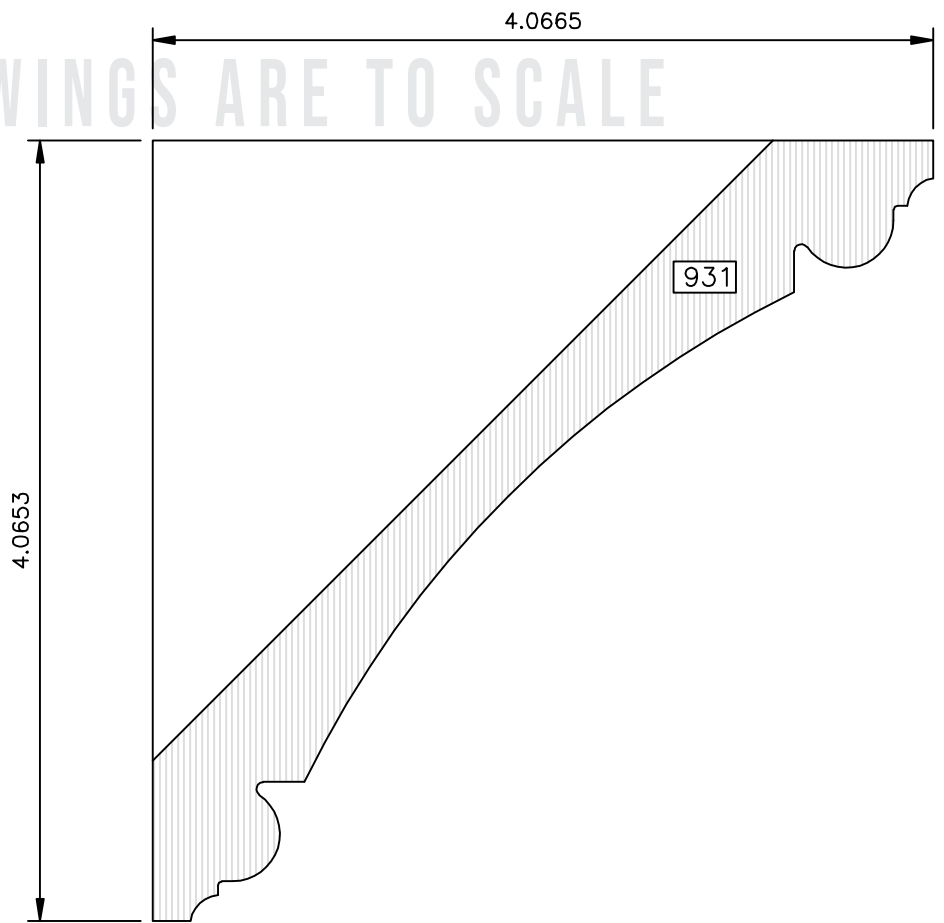

.8125" x 5.75"

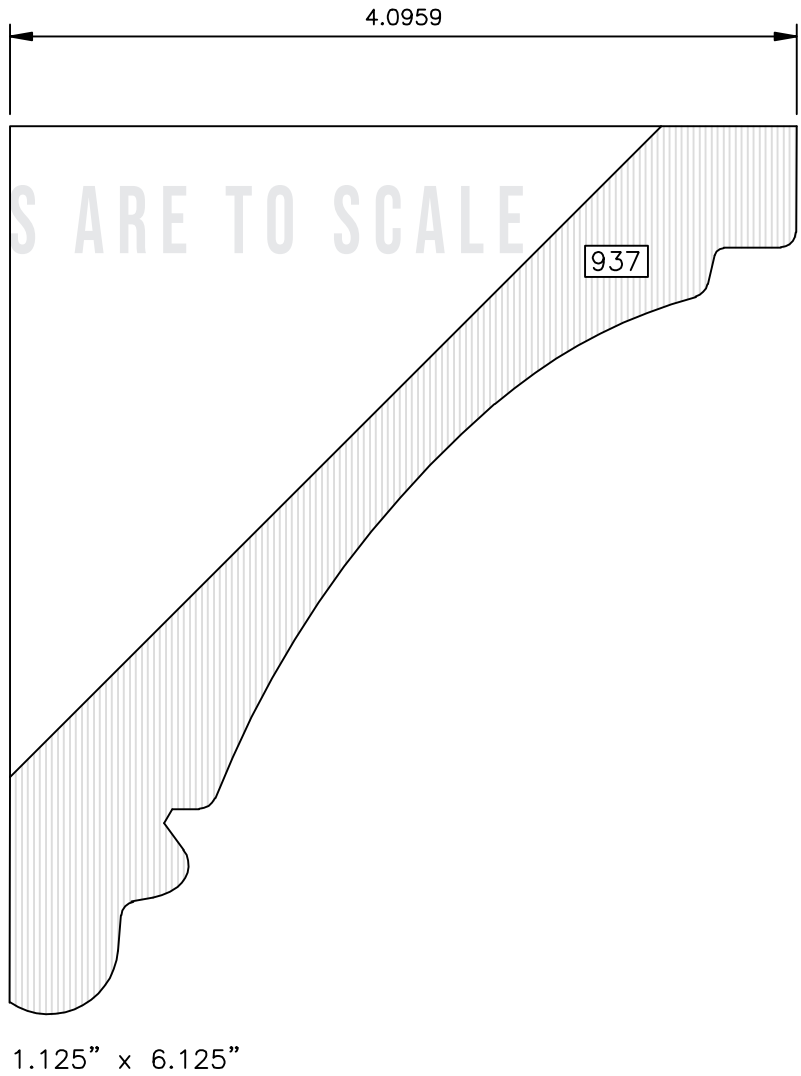
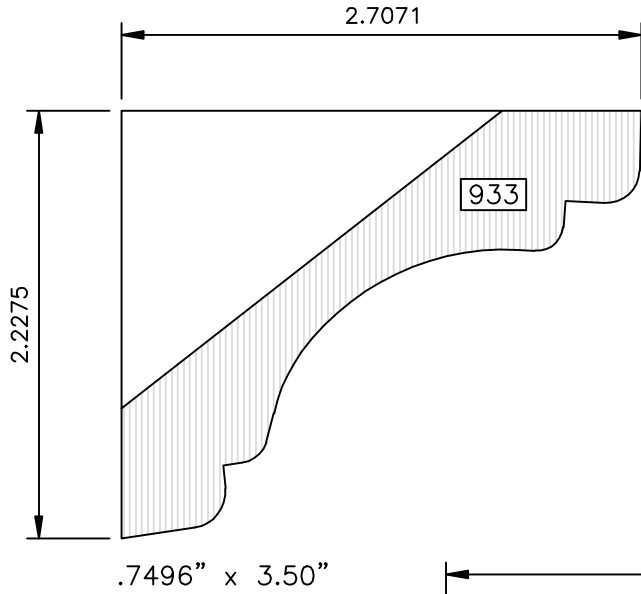

DRAWINGS ARE TO SCALE

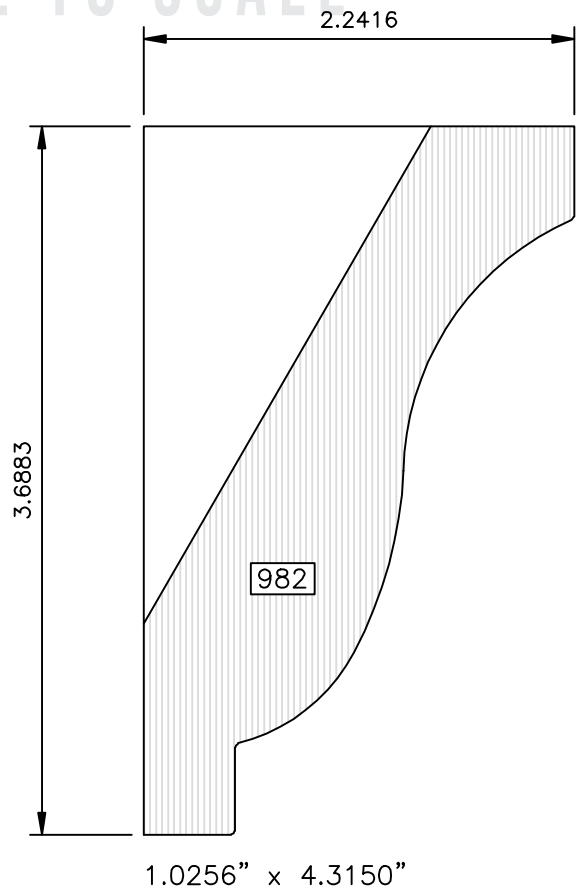
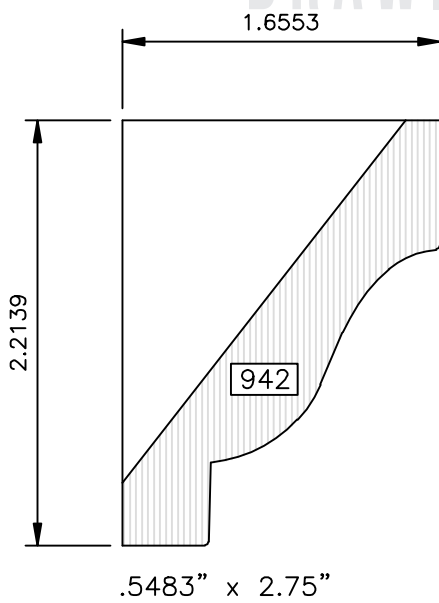
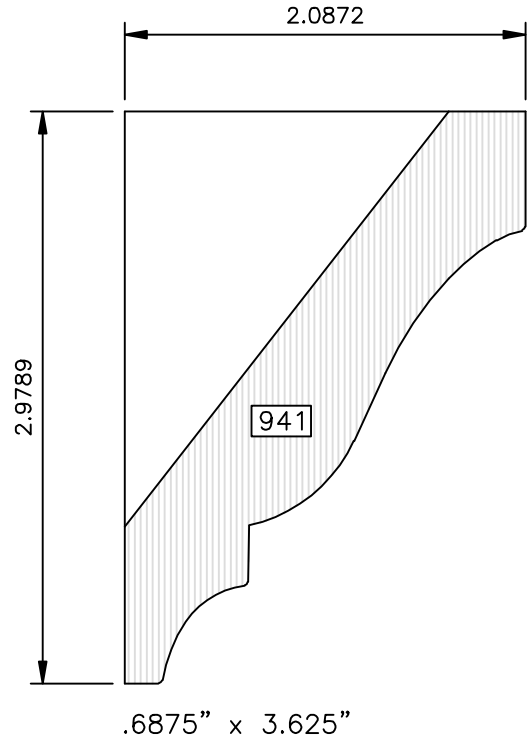
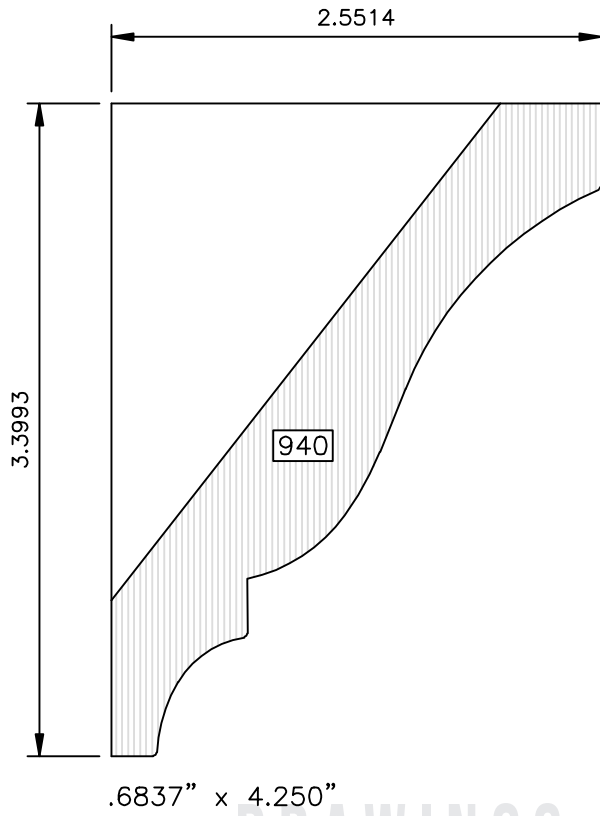

DRAWINGS ARE TO SCALE

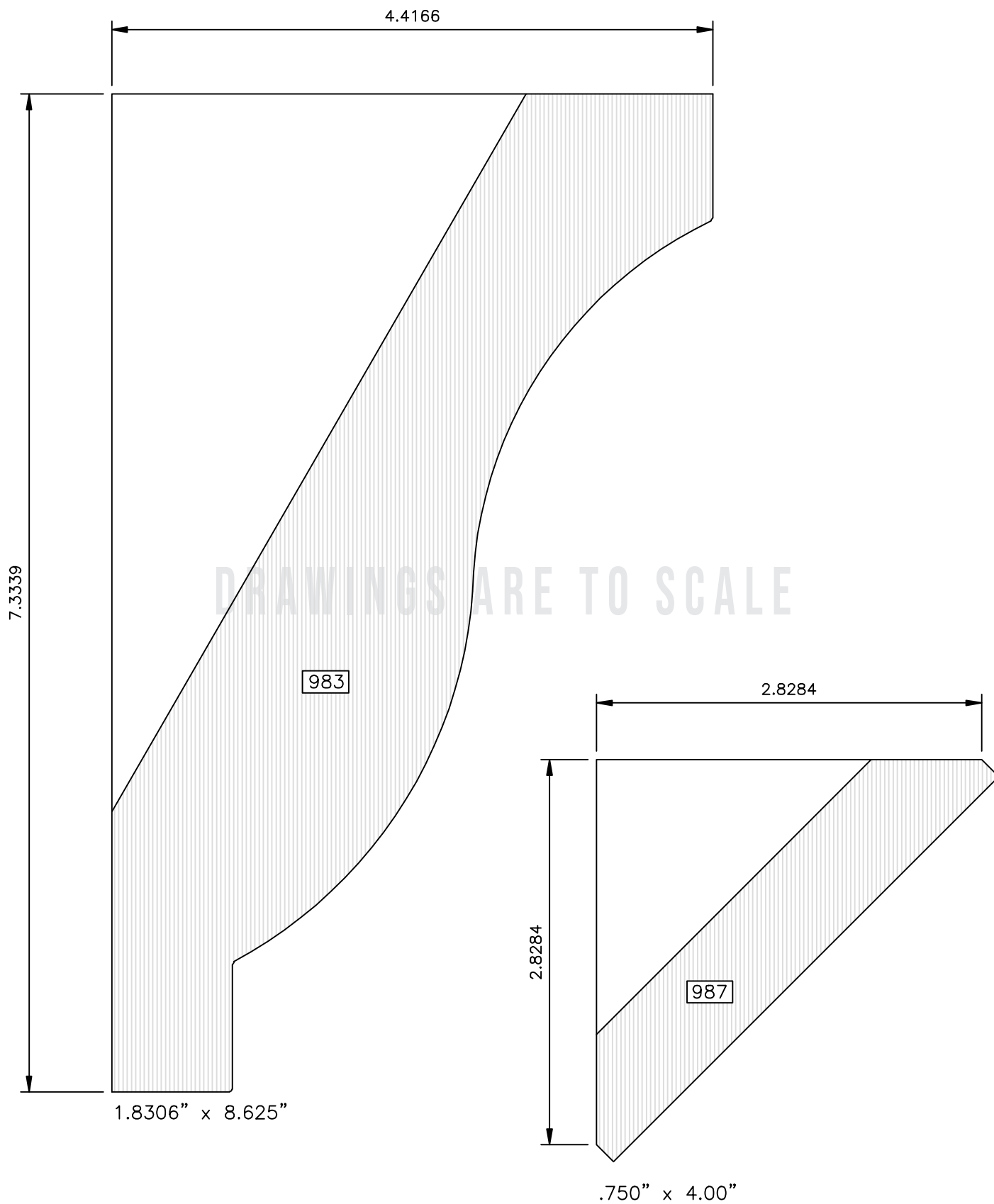

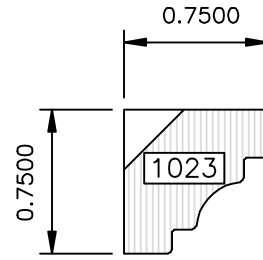
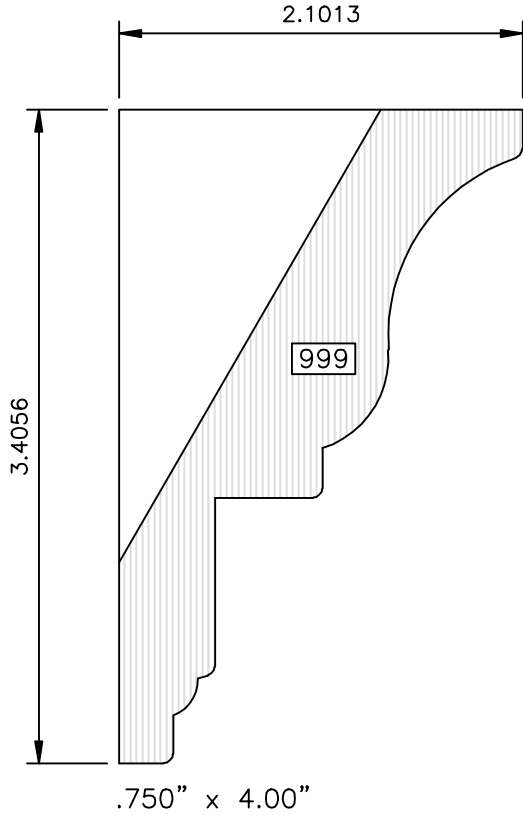

DRAWINGS ARE TO SCALE

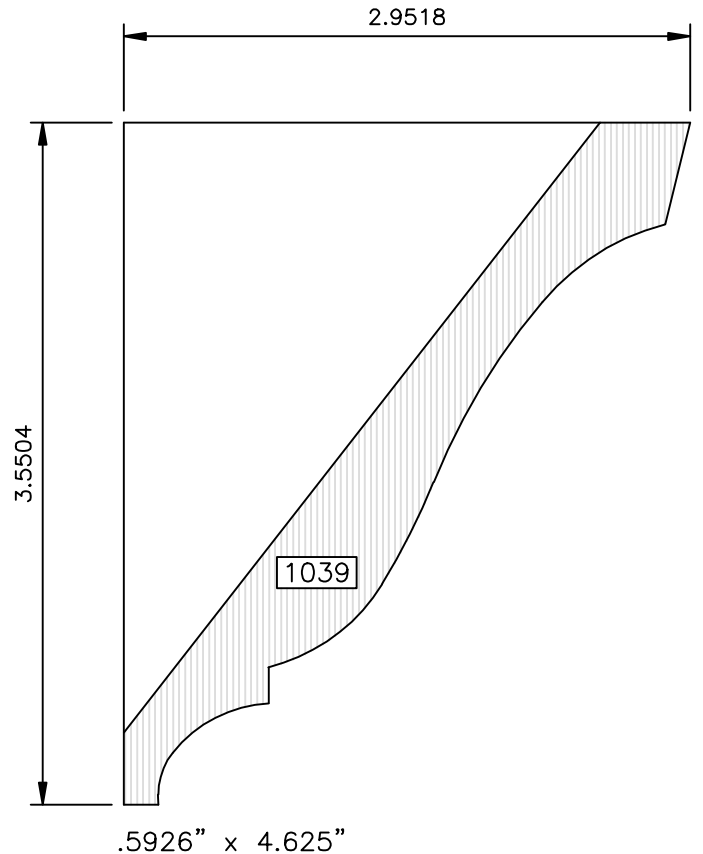
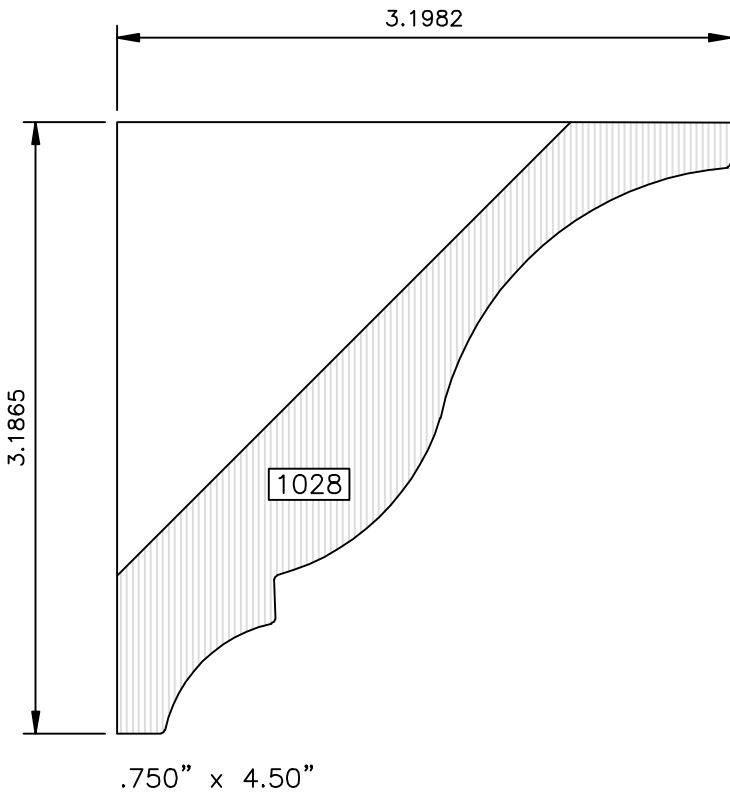

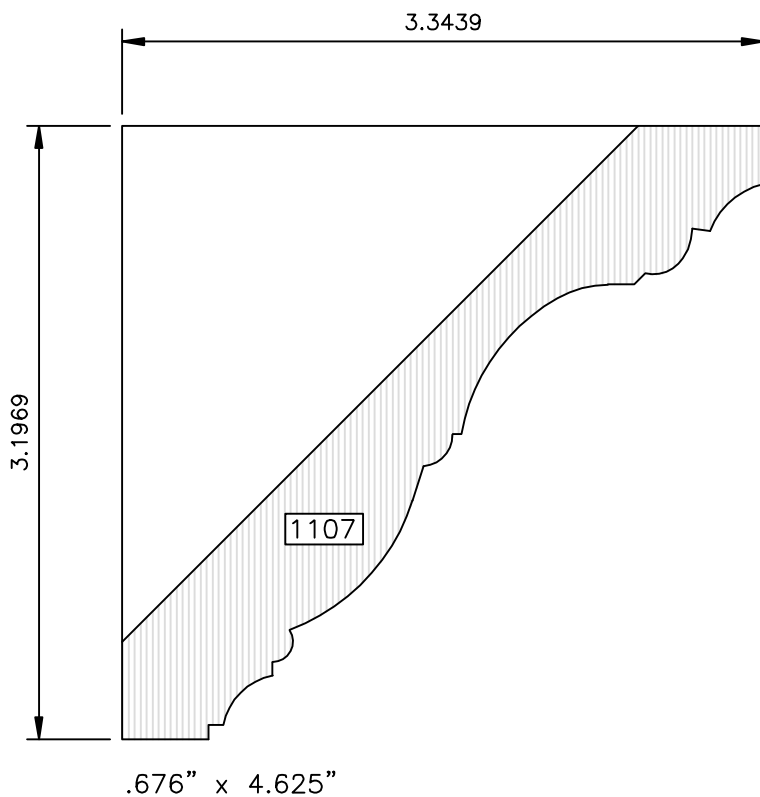
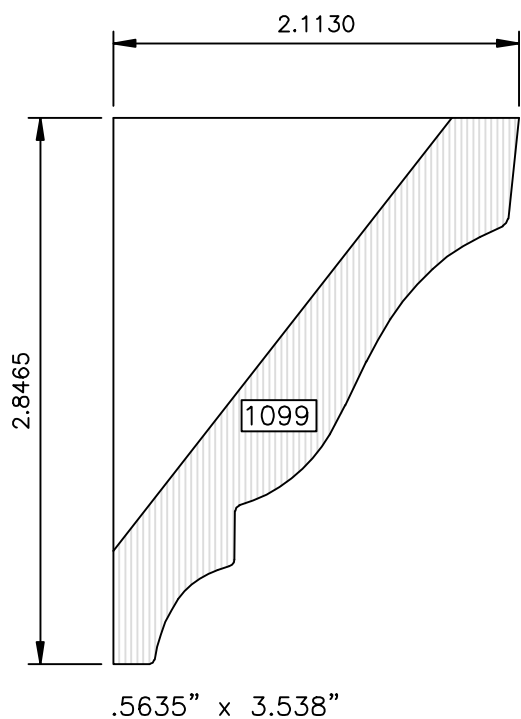

DRAWINGS ARE TO SCALE

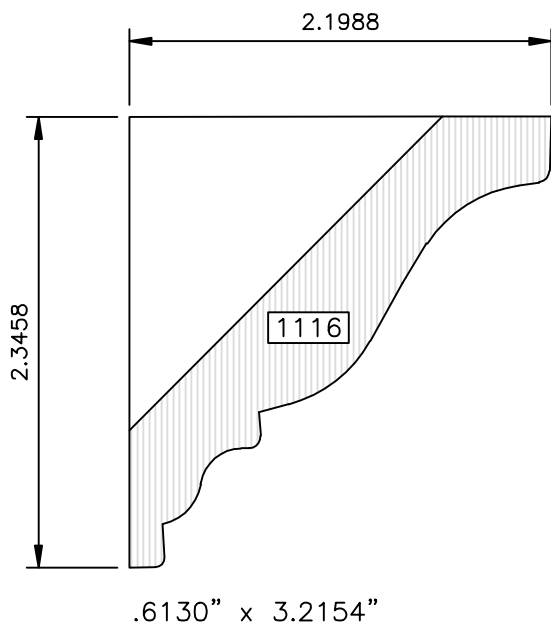

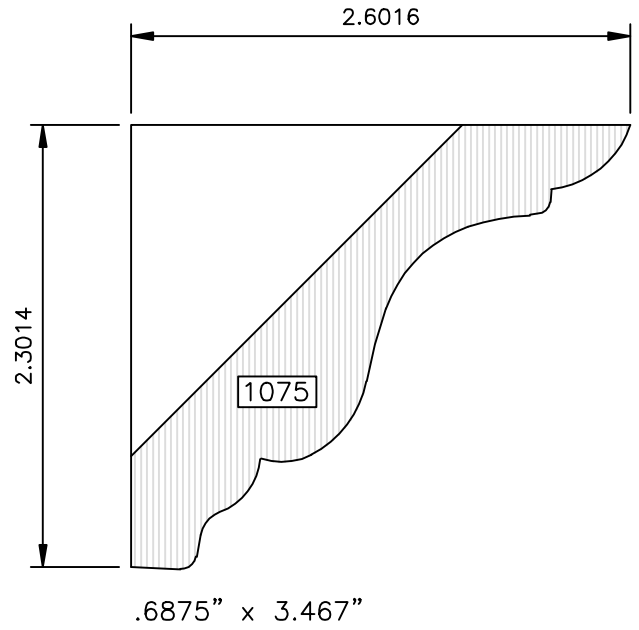
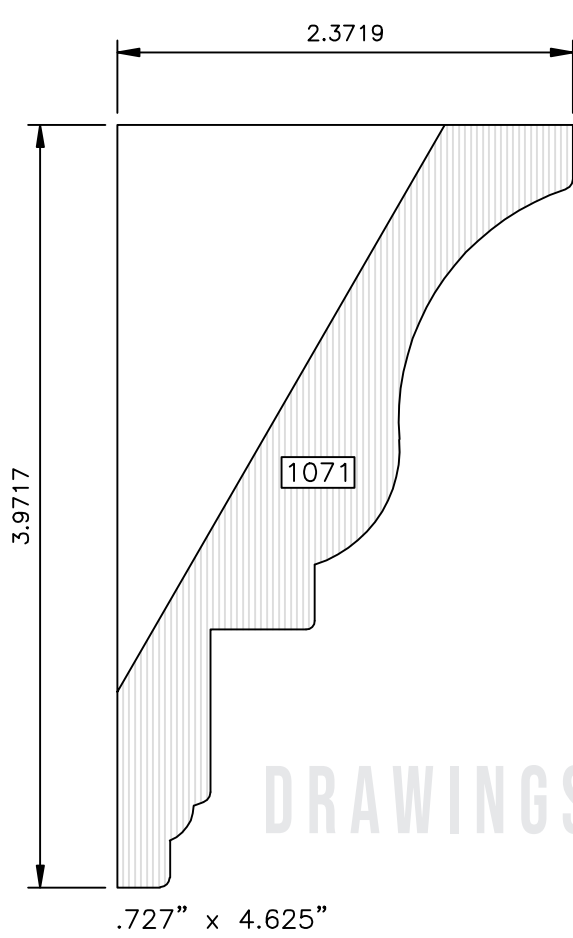

DRAWINGS ARE TO SCALE

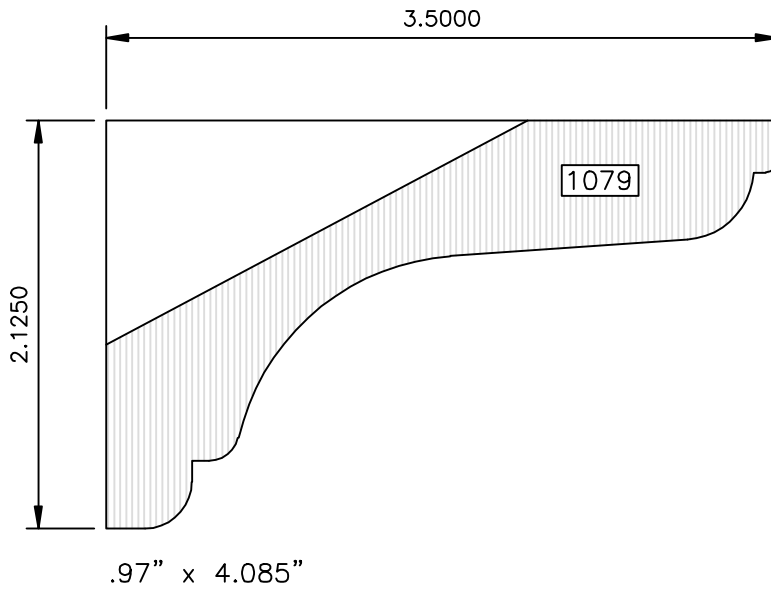

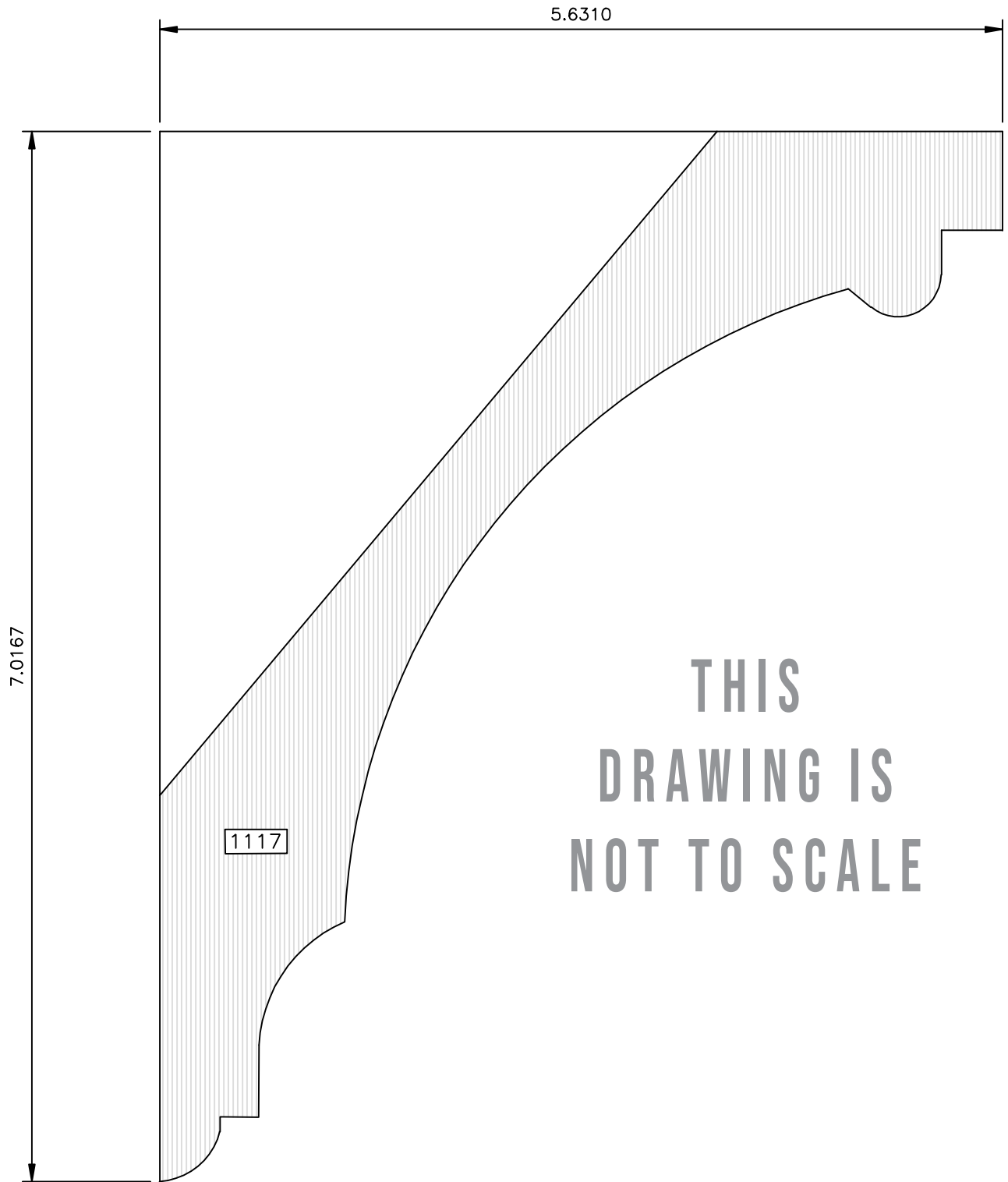

1.8877" x 8.999"

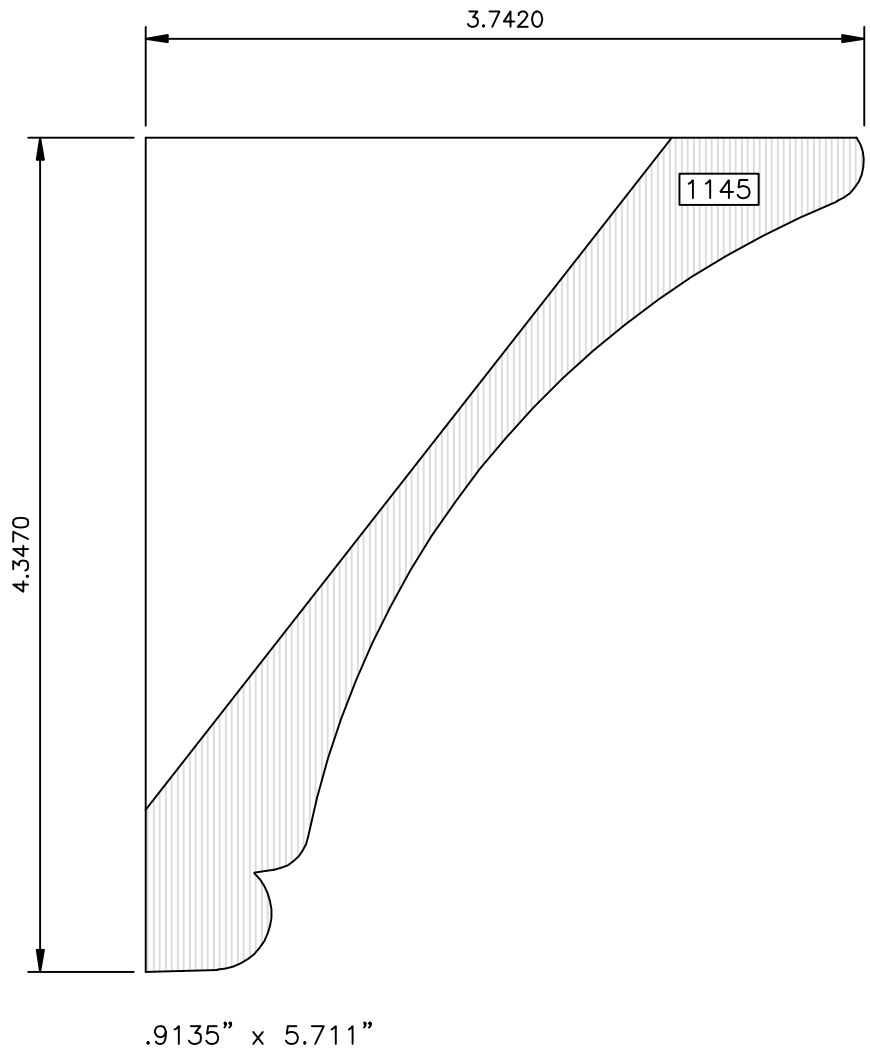
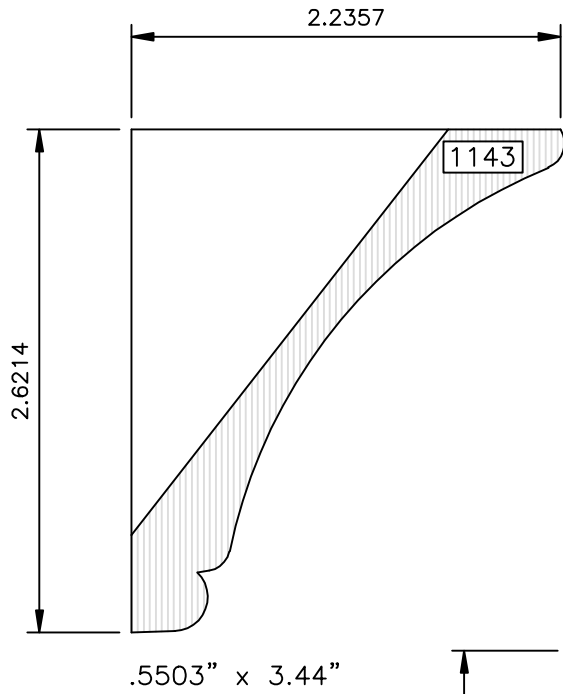

DRAWINGS ARE TO SCALE



DRAWINGS ARE TO SCALE

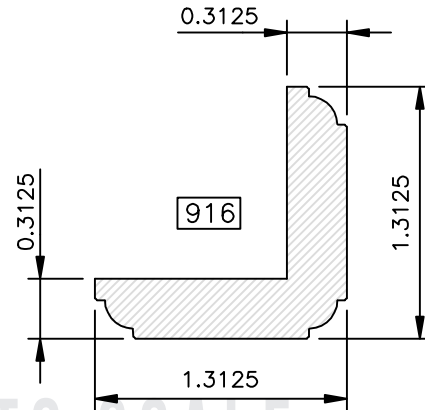
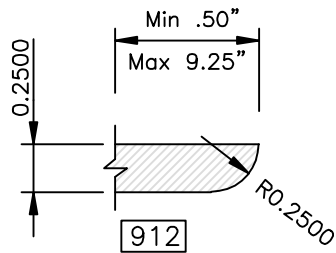
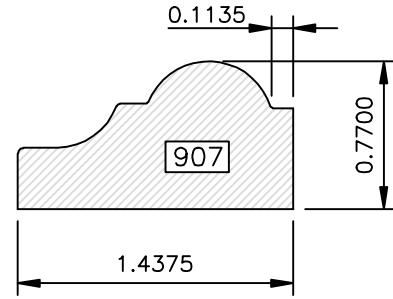
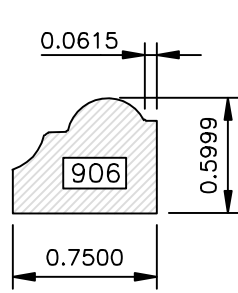

DRAWINGS ARE TO SCALE

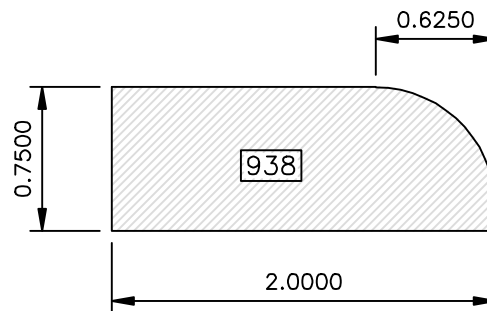
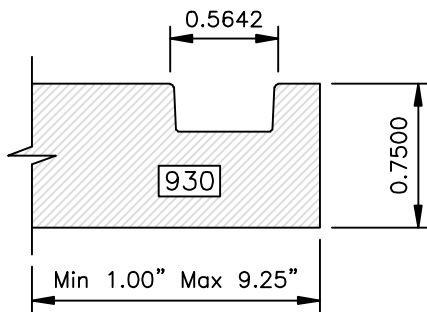
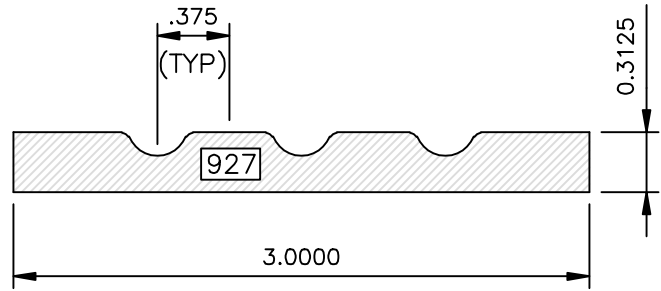
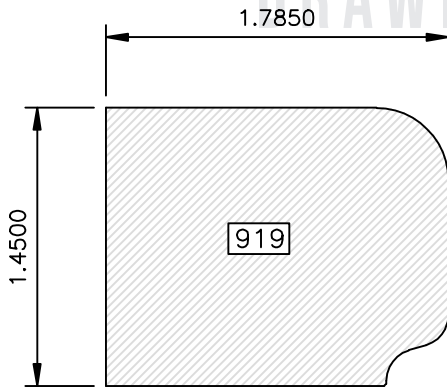

MISCELLANEOUS PROFILES

Go West!

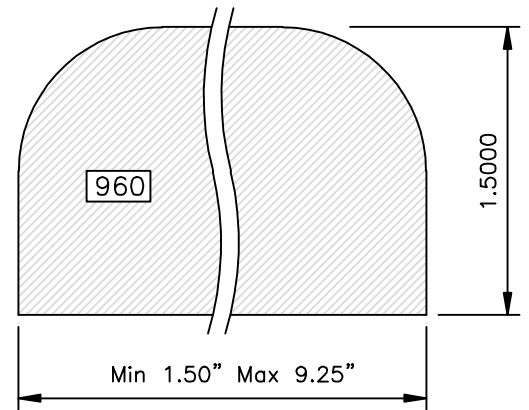
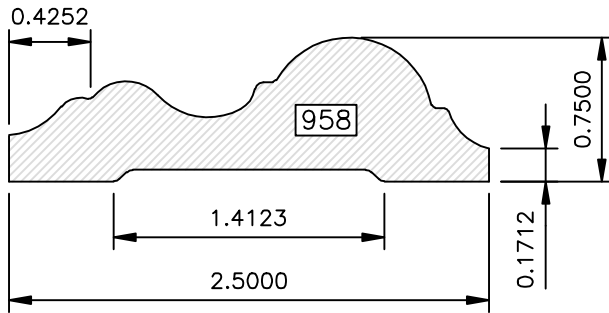
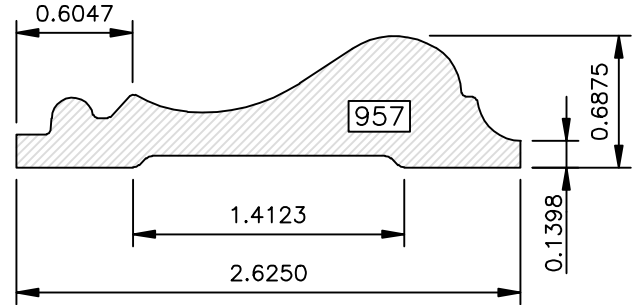
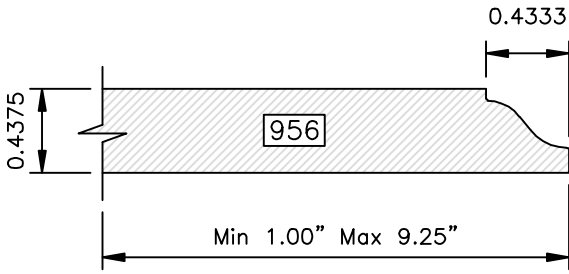

DRAWINGS ARE TO SCALE

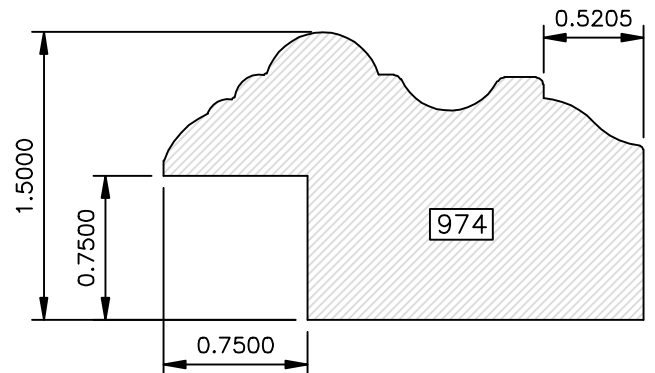
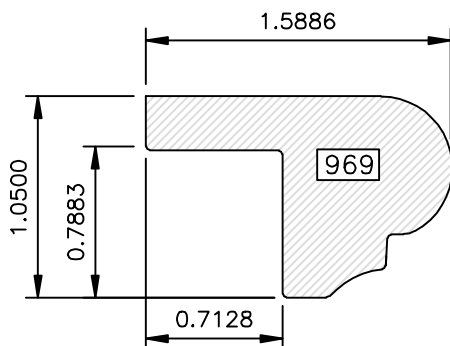
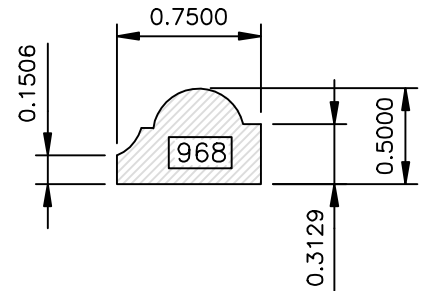
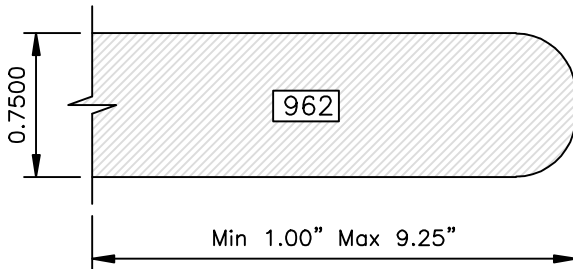

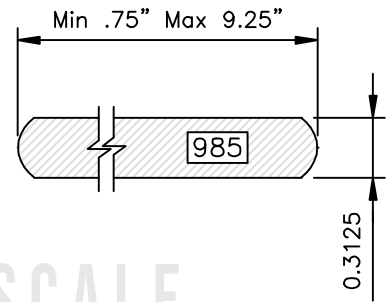
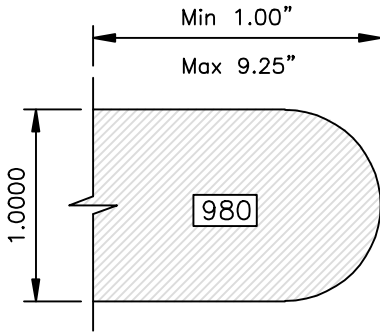
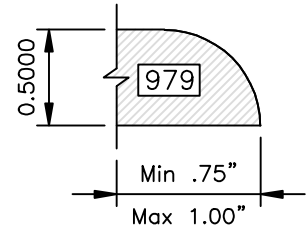
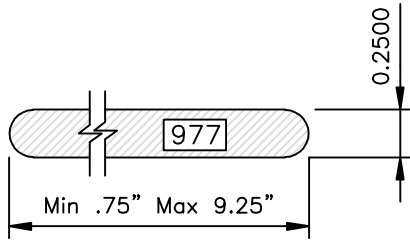

DRAWINGS ARE TO SCALE

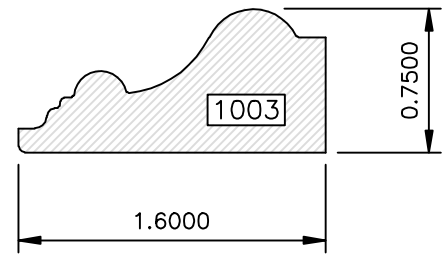
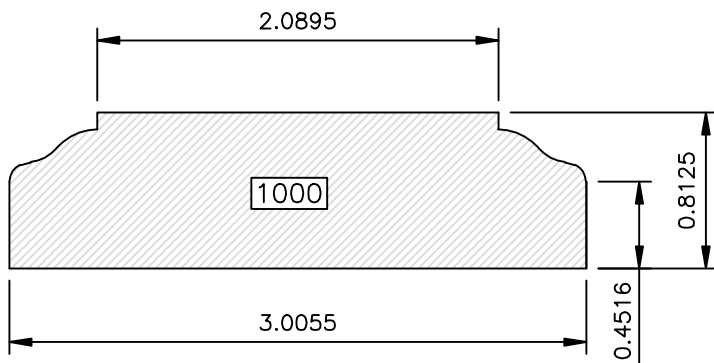
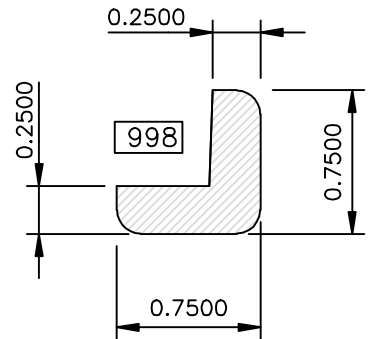
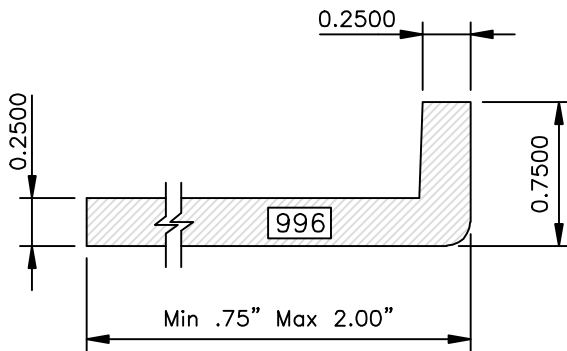

MISCELLANEOUS PROFILES

Go West!

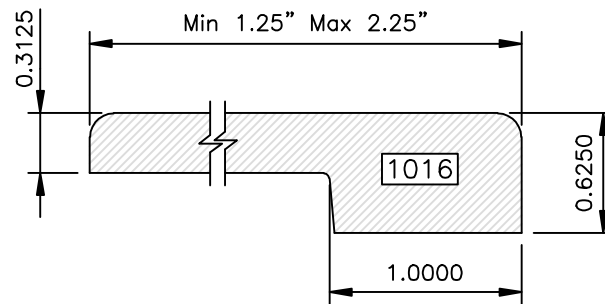
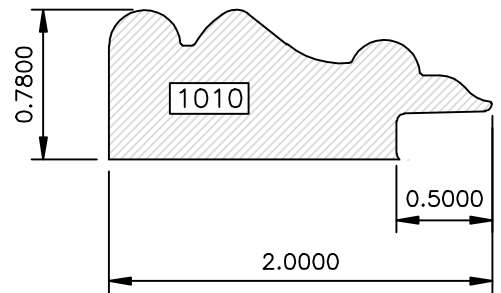
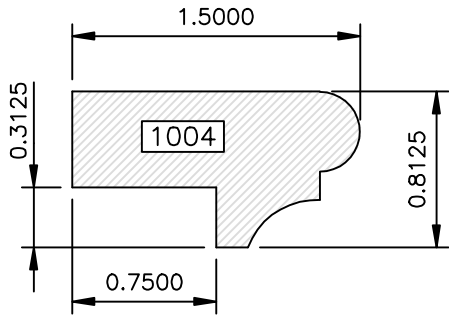

DRAWINGS ARE TO SCALE

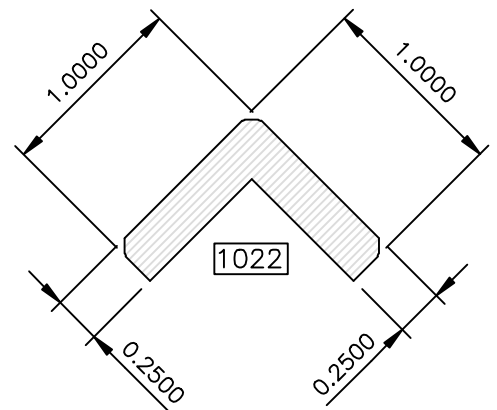
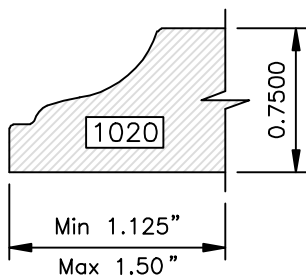
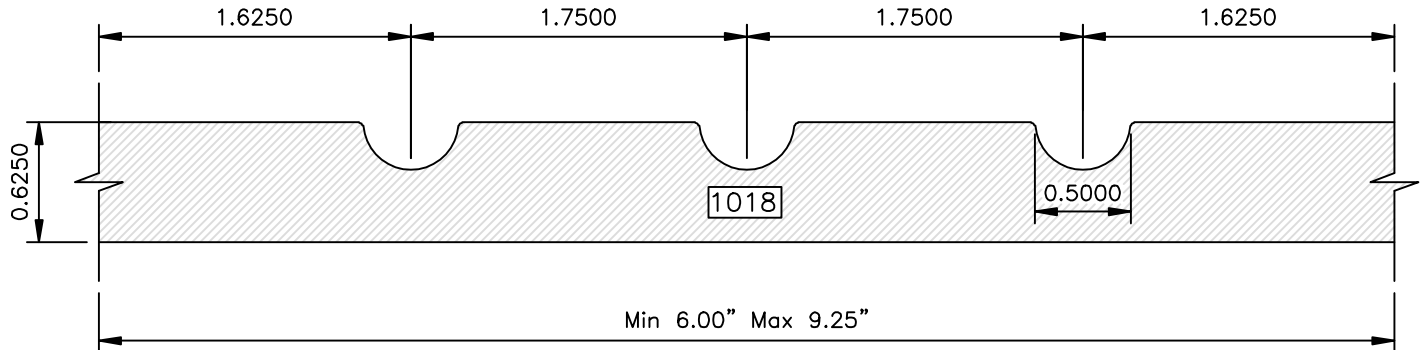

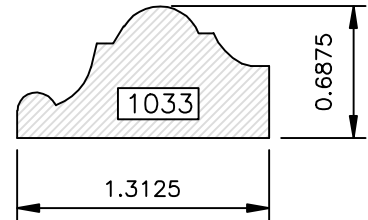
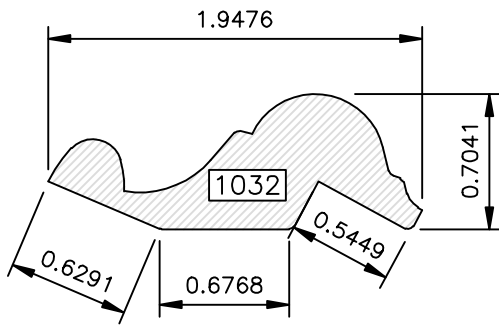
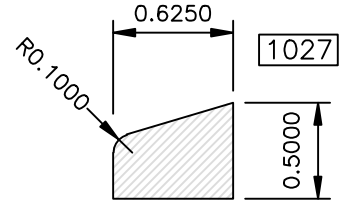
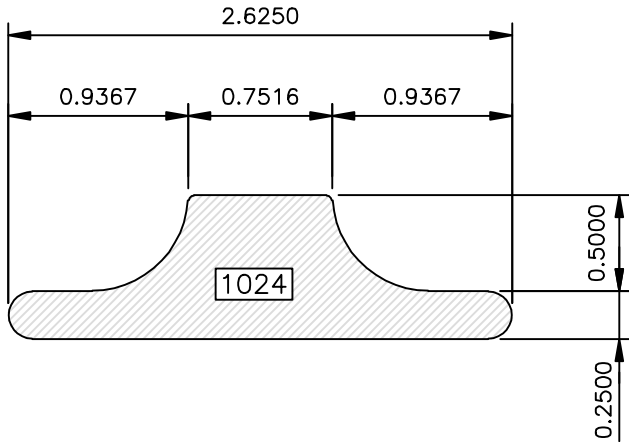

DRAWINGS ARE TO SCALE

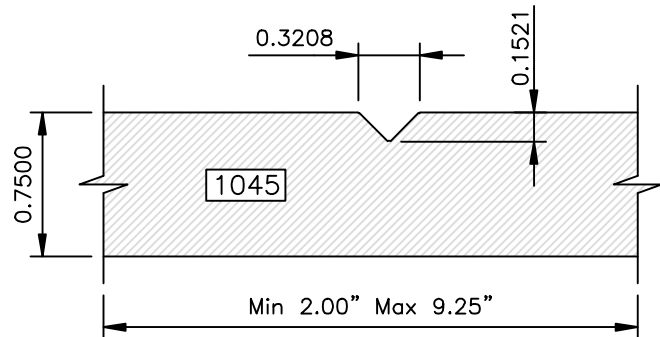
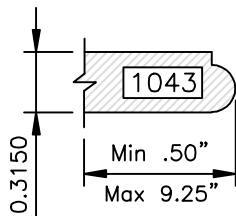
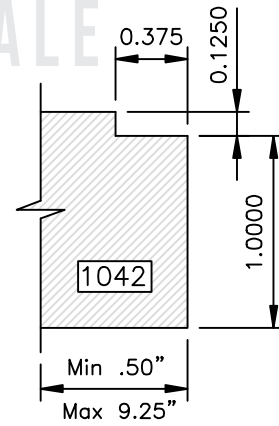
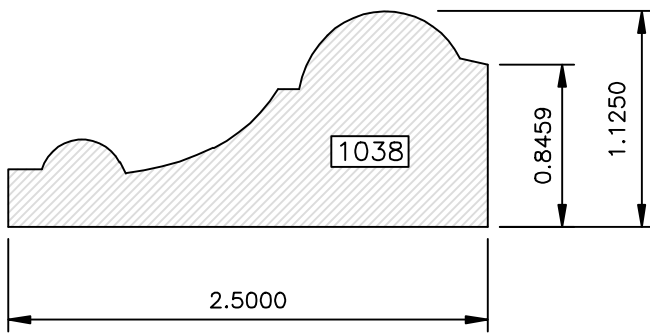

MISCELLANEOUS PROFILES

Go West!

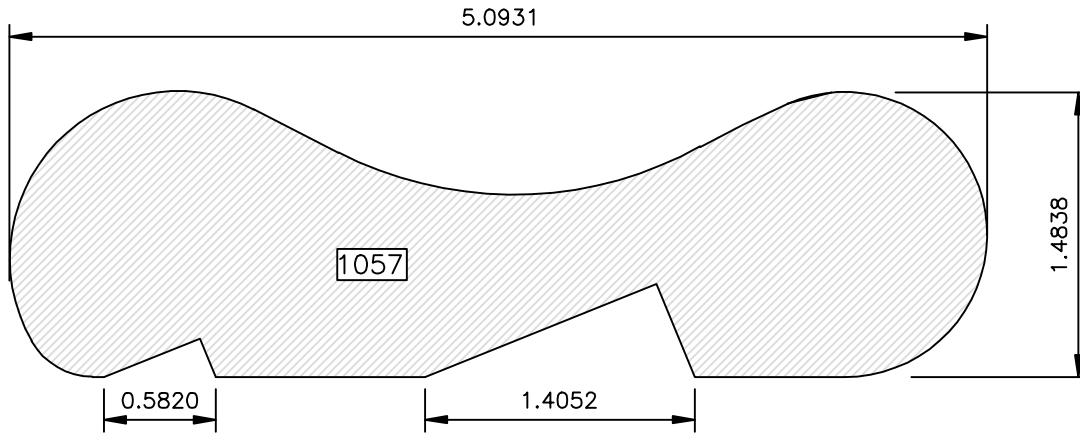
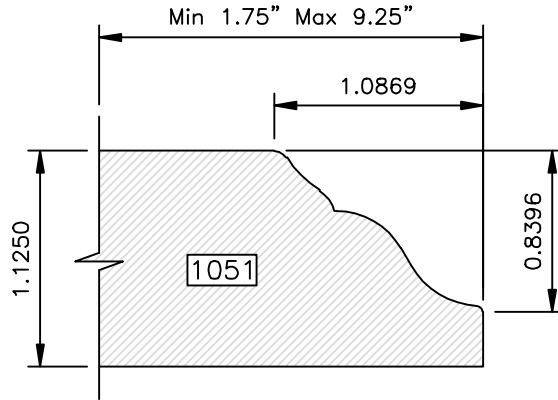

DRAWINGS ARE TO SCALE

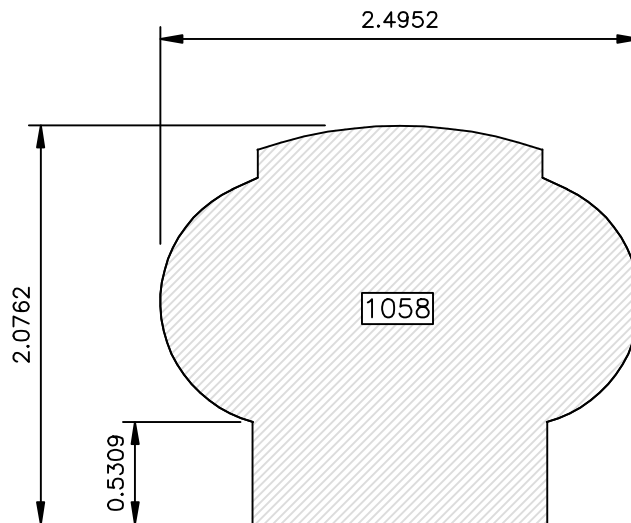

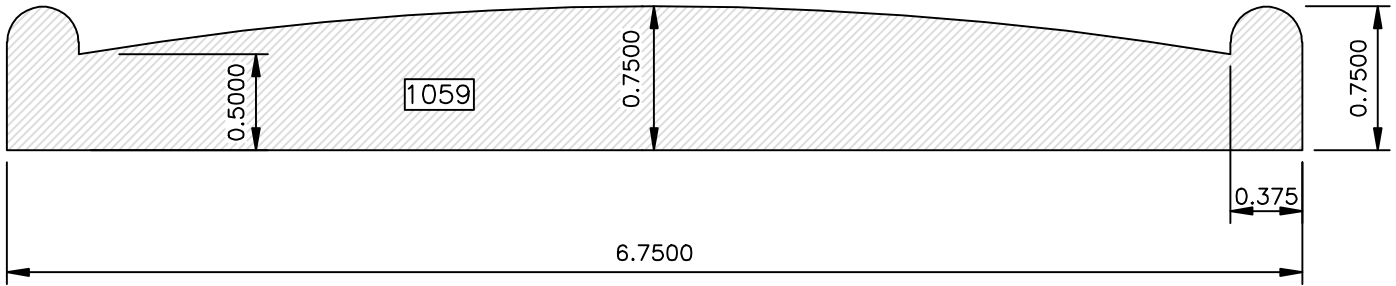

DRAWINGS ARE TO SCALE

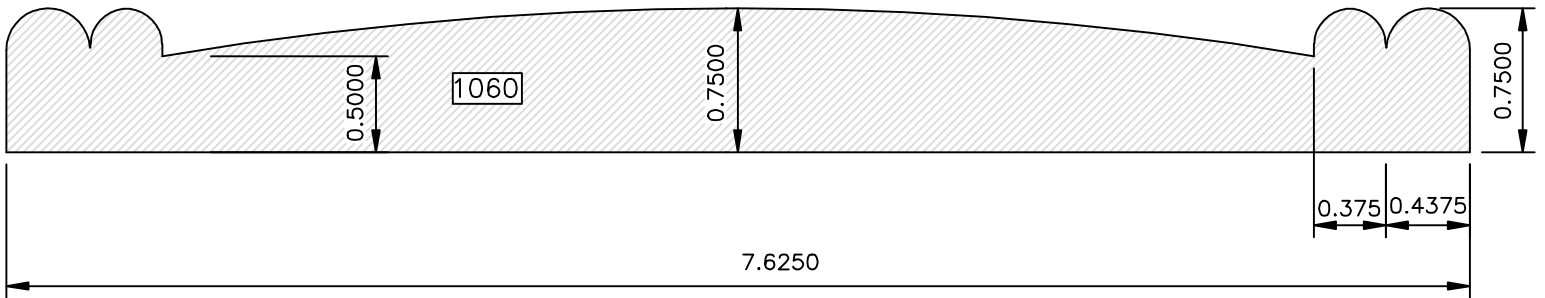

MISCELLANEOUS PROFILES

Go West!

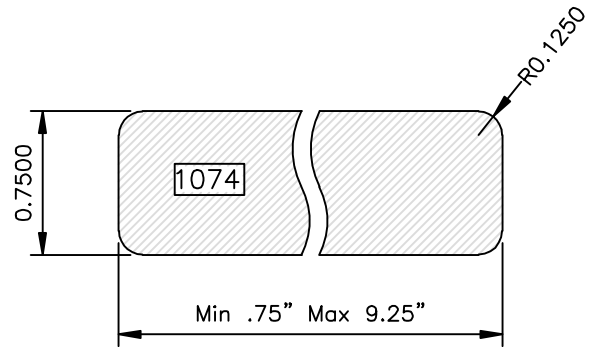
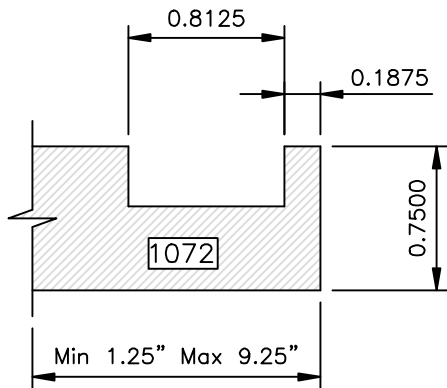
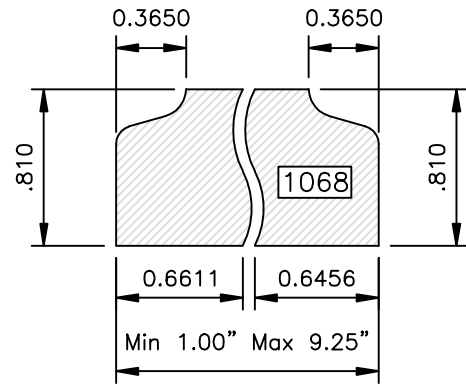
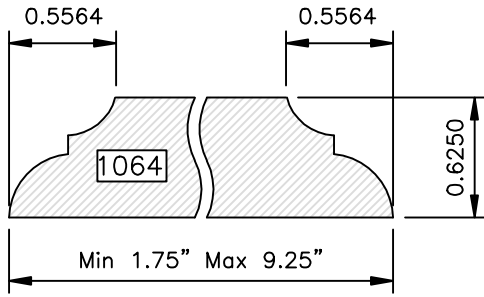

DRAWINGS ARE TO SCALE

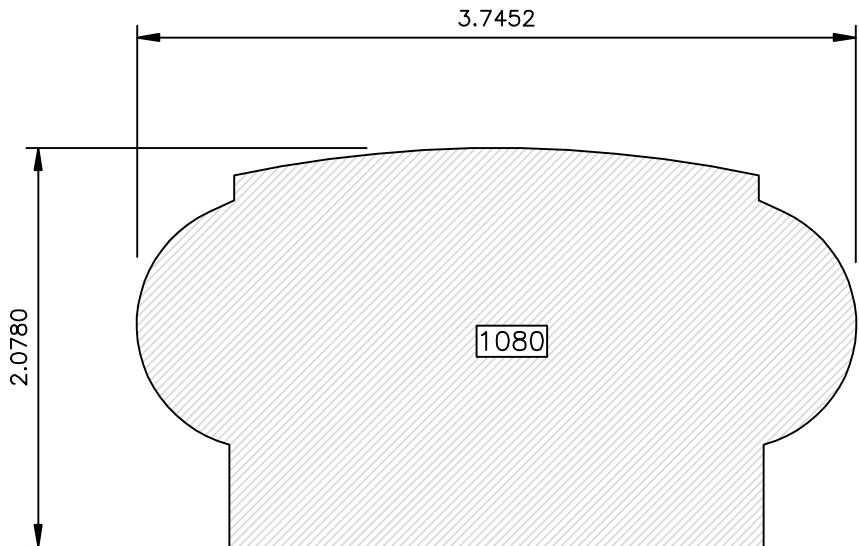
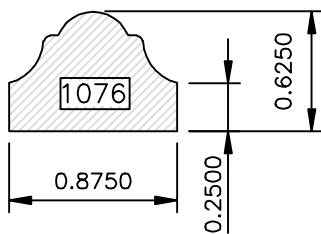

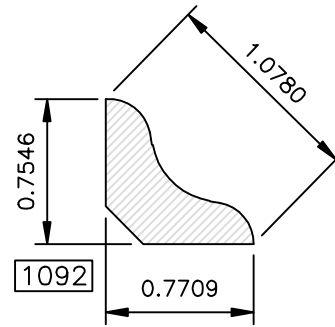
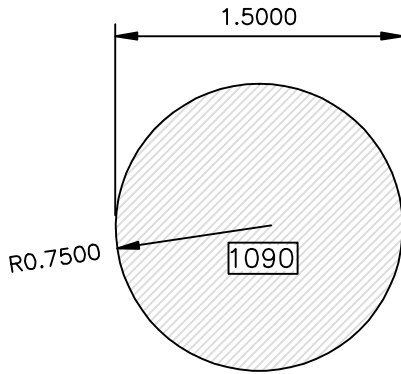
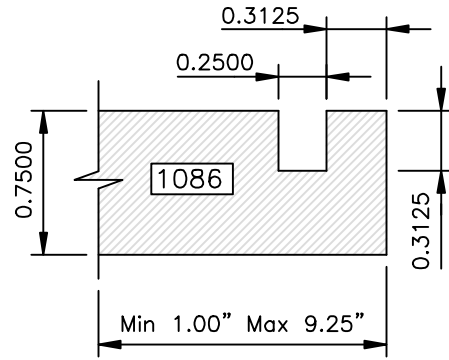
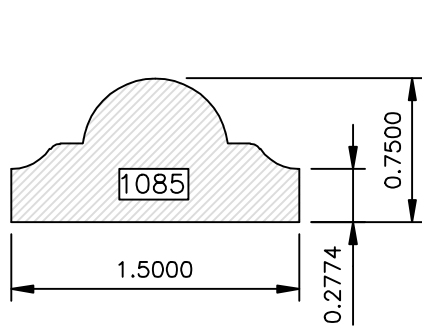

DRAWINGS ARE TO SCALE

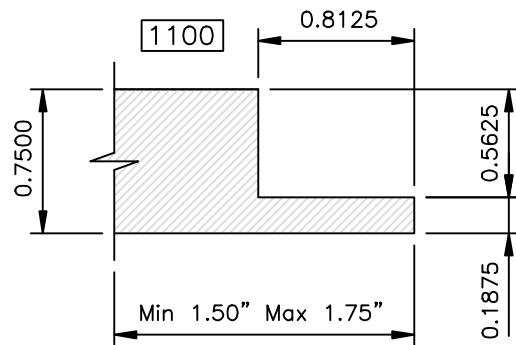
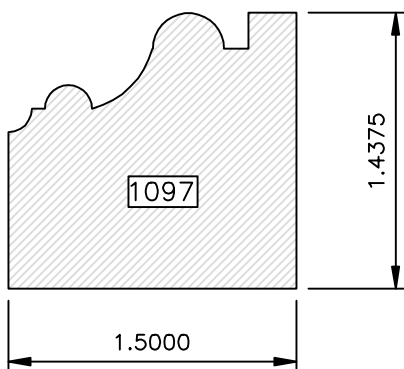
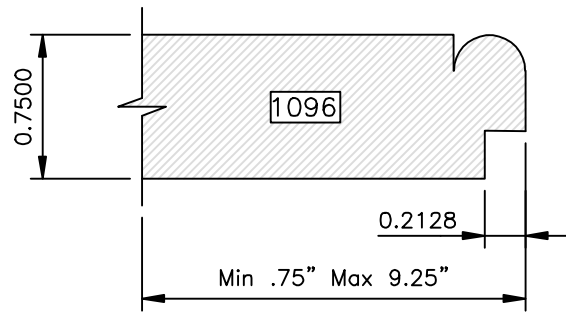
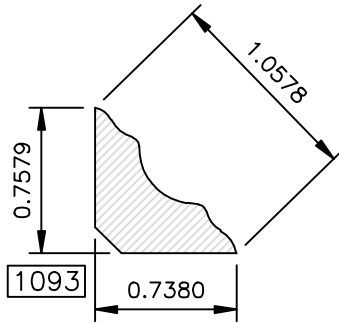

MISCELLANEOUS PROFILES

Go West!

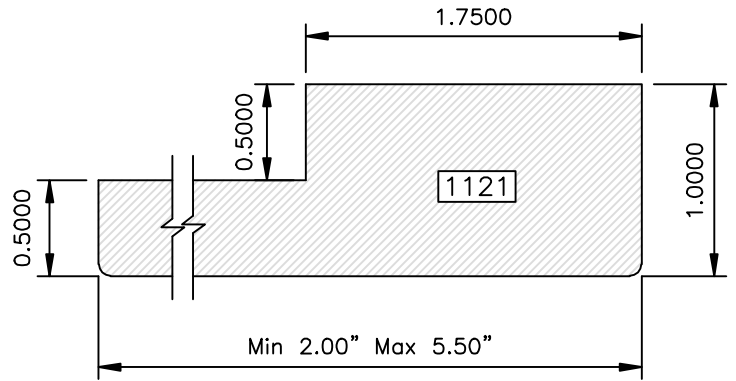
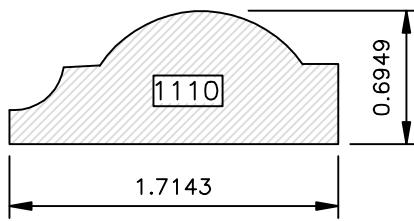
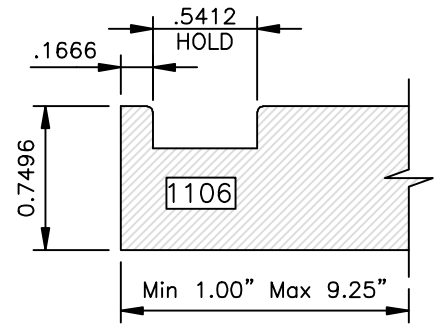
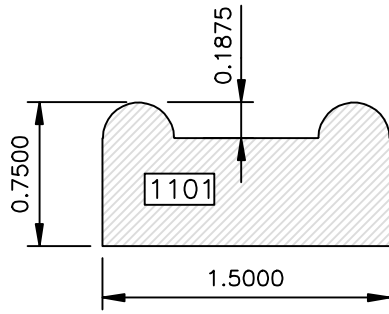

DRAWINGS ARE TO SCALE

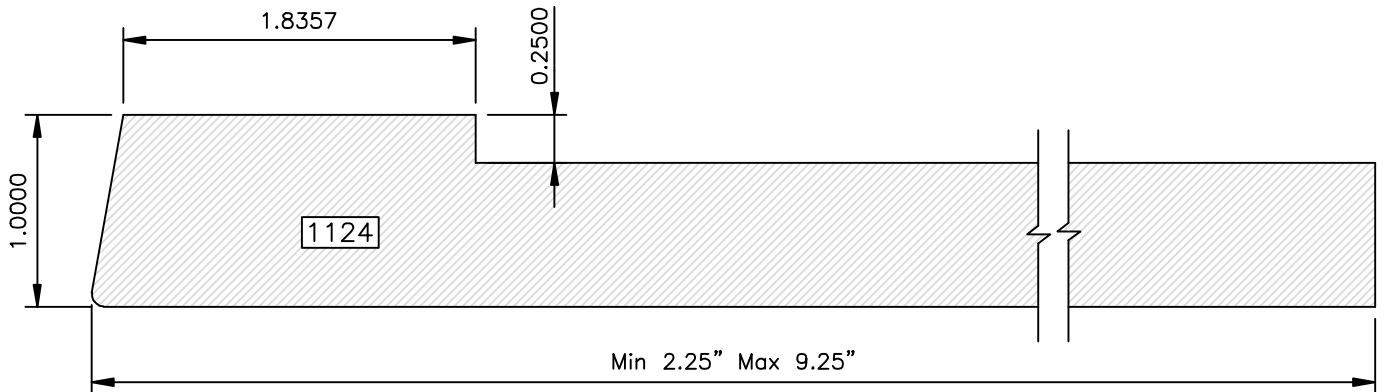
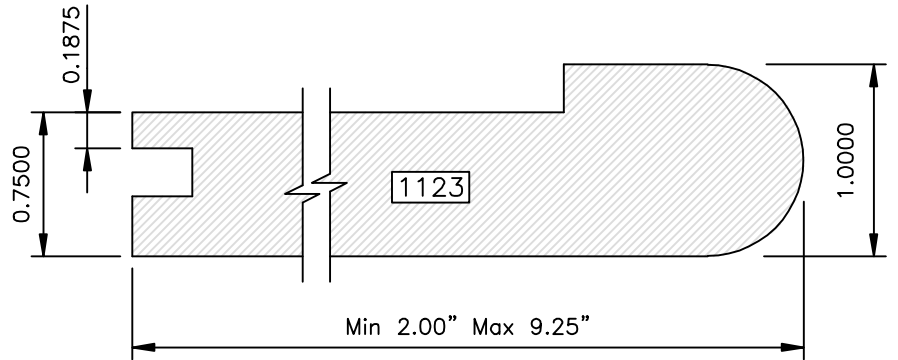
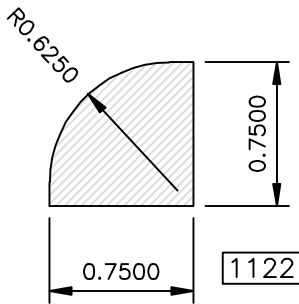

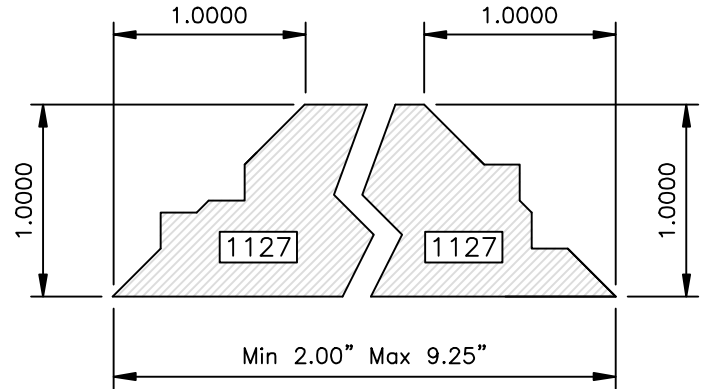
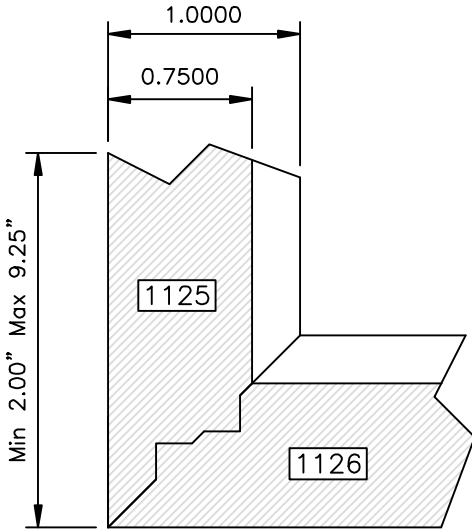

DRAWINGS ARE TO SCALE

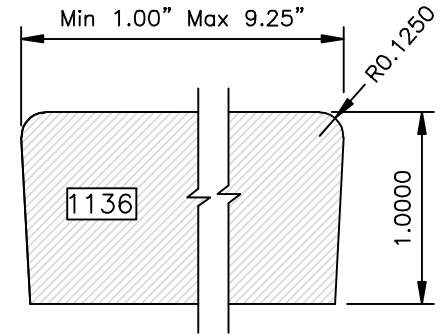
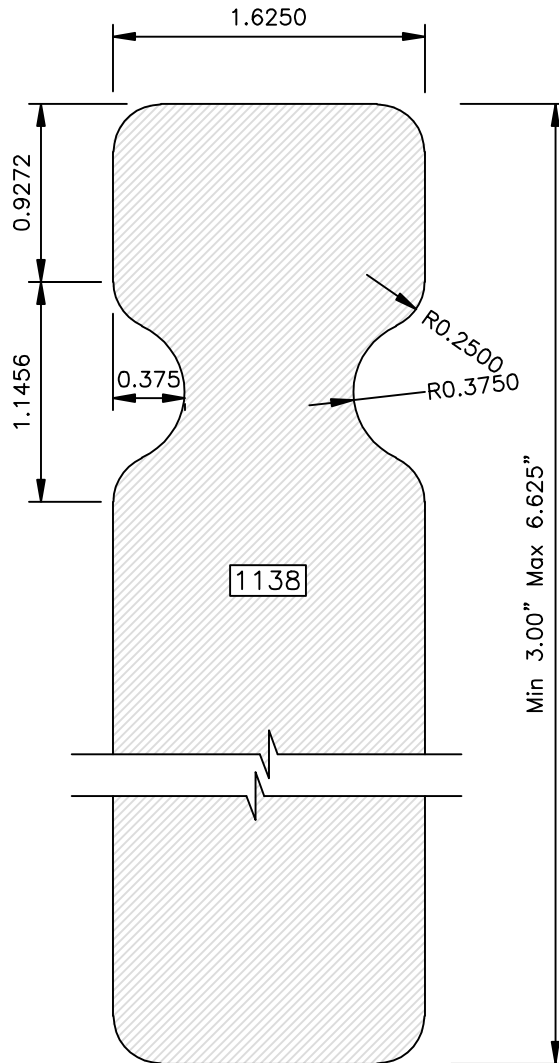
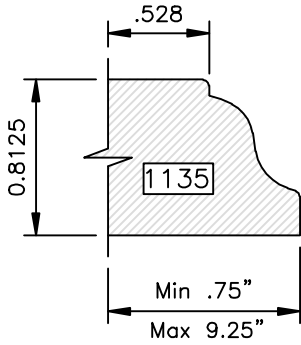

MISCELLANEOUS PROFILES

Go West!

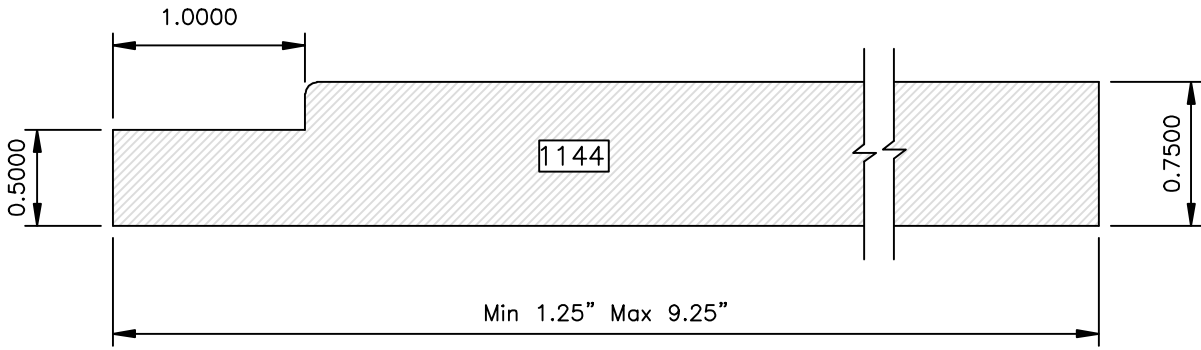

DRAWINGS ARE TO SCALE

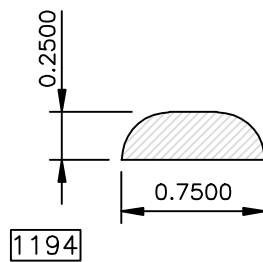
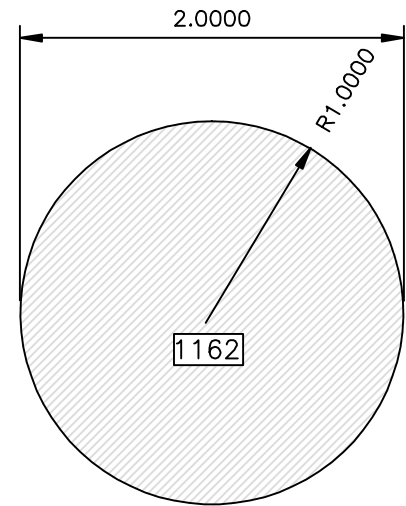
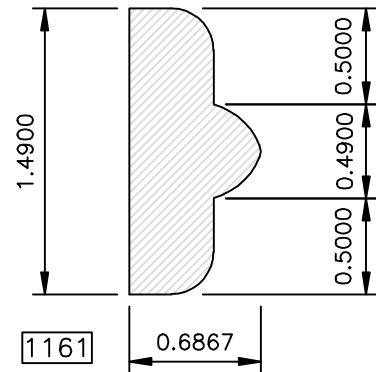
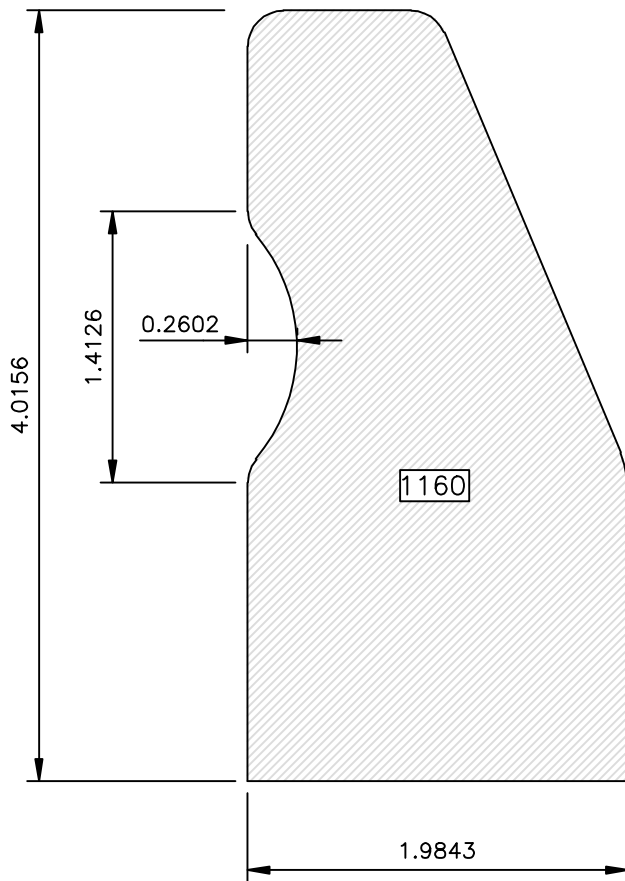

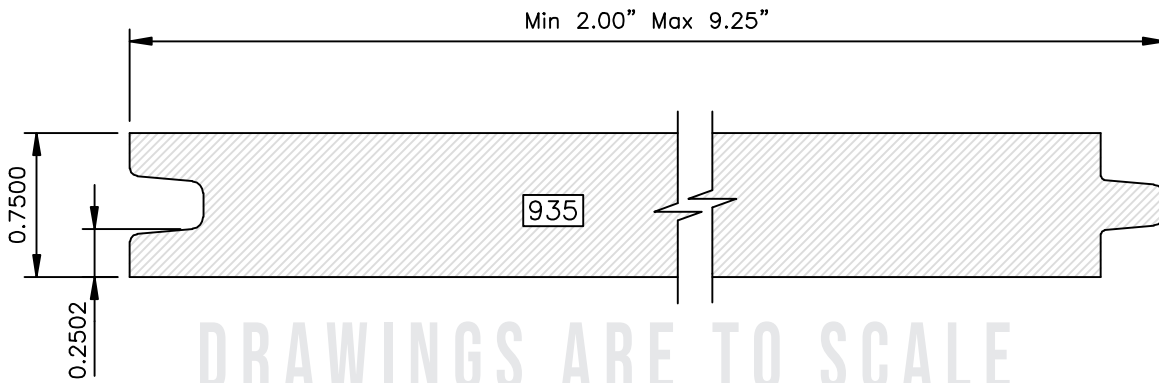
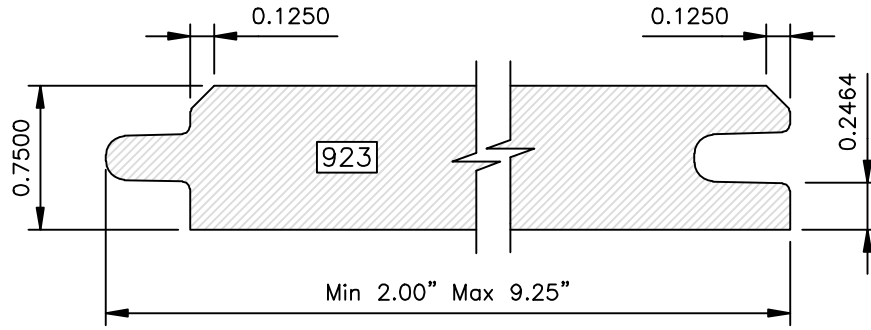

DRAWINGS ARE TO SCALE

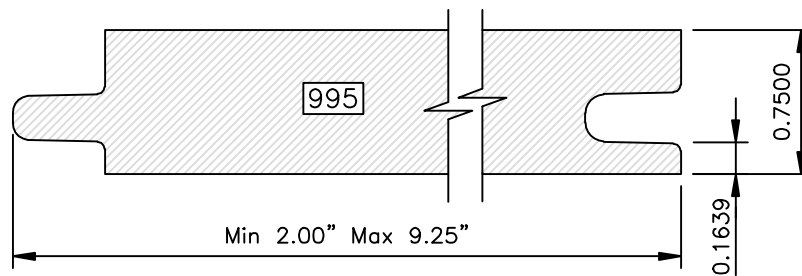
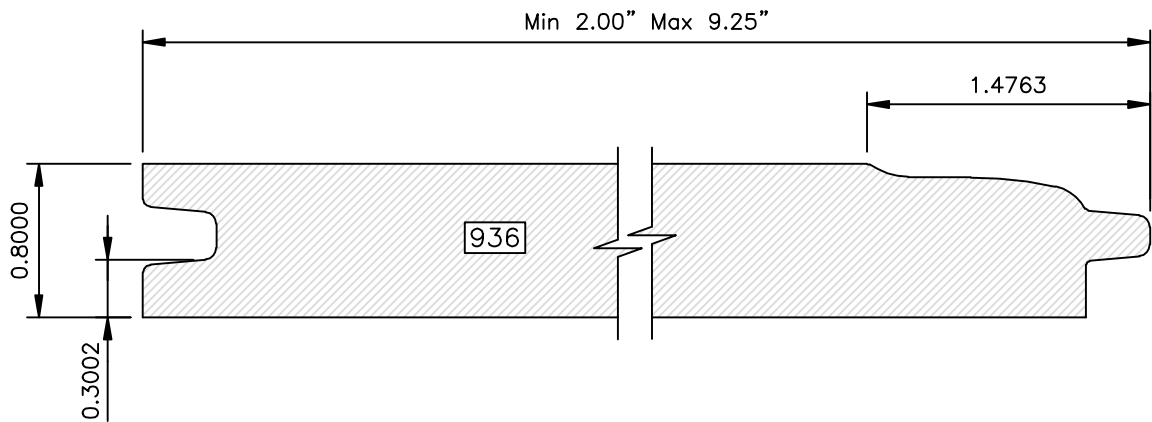

TONGUE & GROOVE PROFILES

Go West!

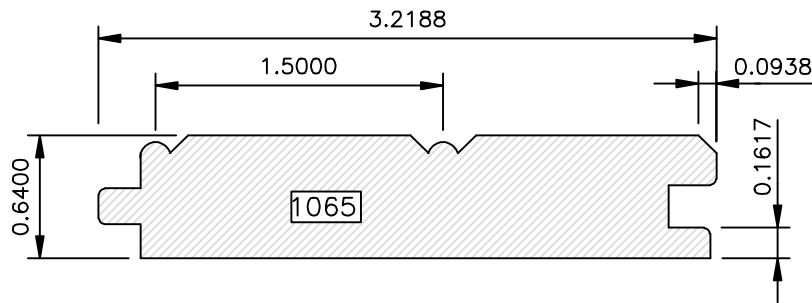
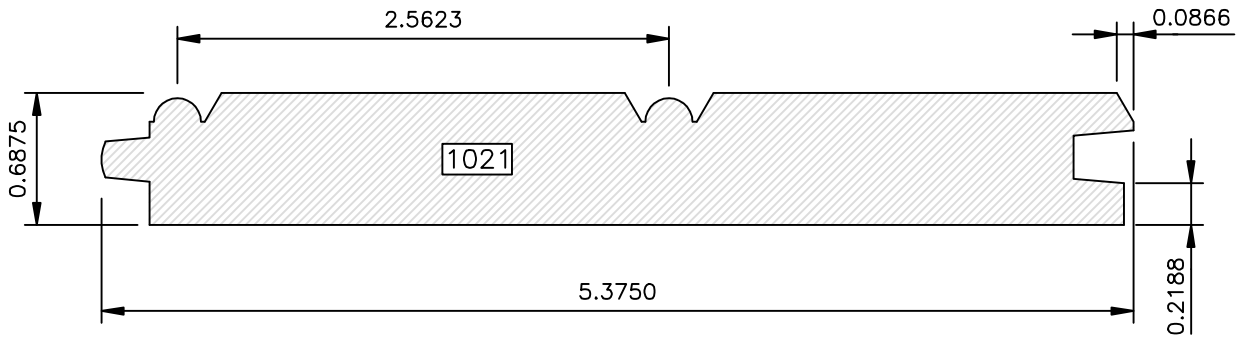
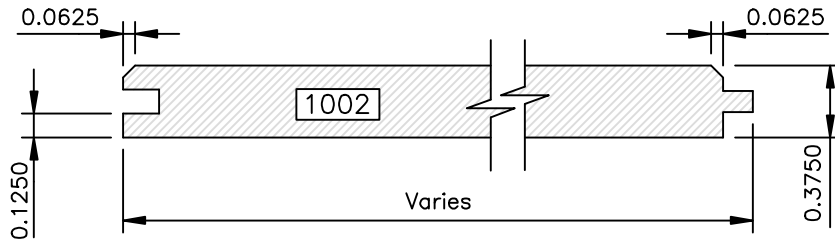
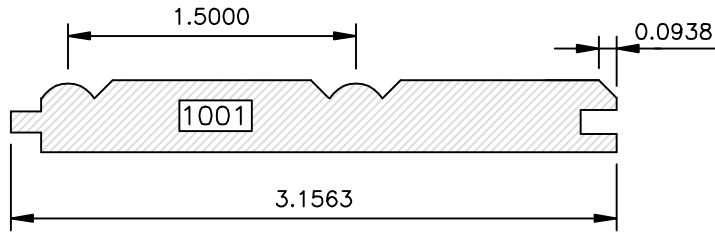

DRAWINGS ARE TO SCALE

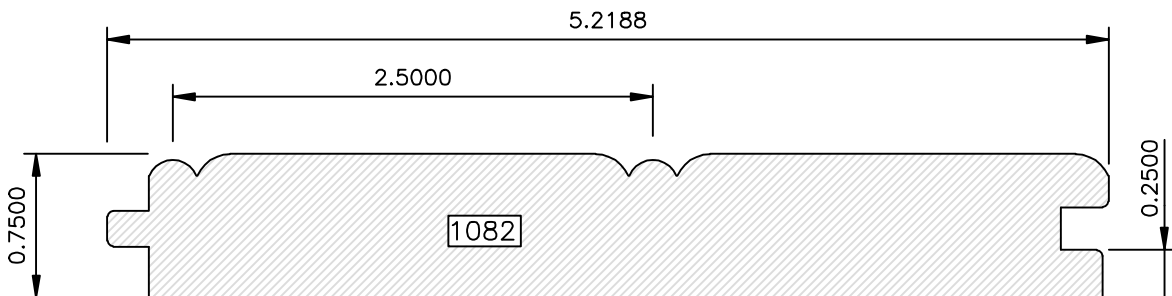

Go West!

MATCHING OUTSIDE EDGE PROFILES

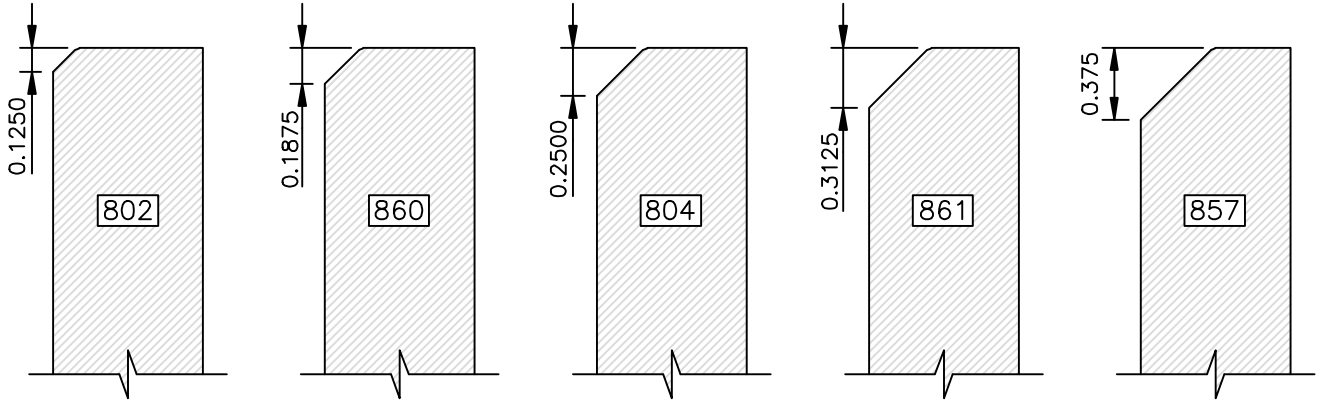

DRAWINGS ARE TO SCALE

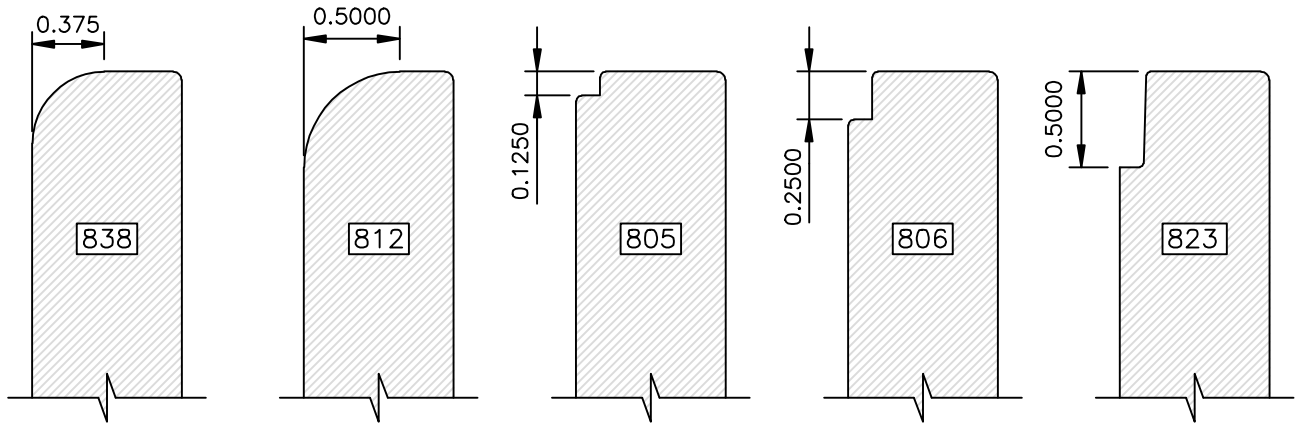
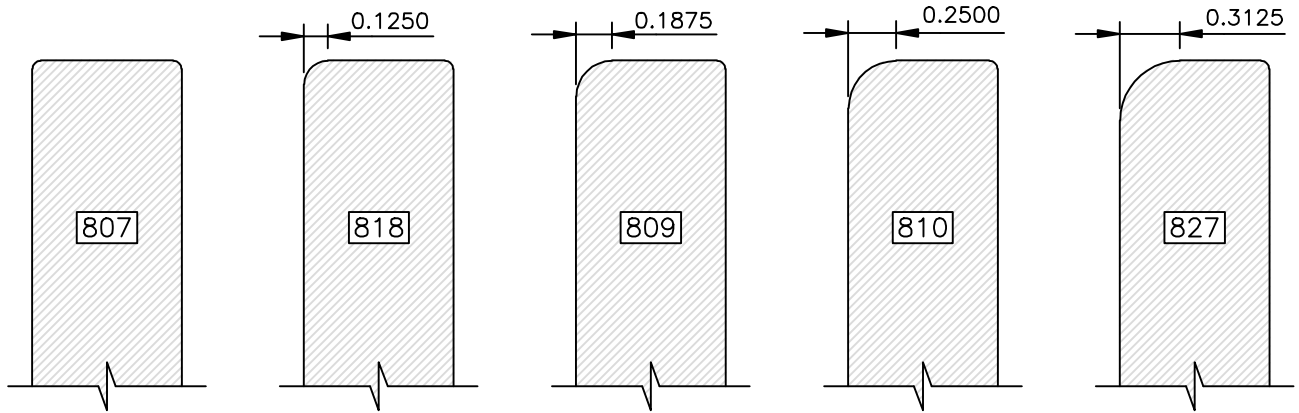

MATCHING OUTSIDE EDGE PROFILES

— Go West!

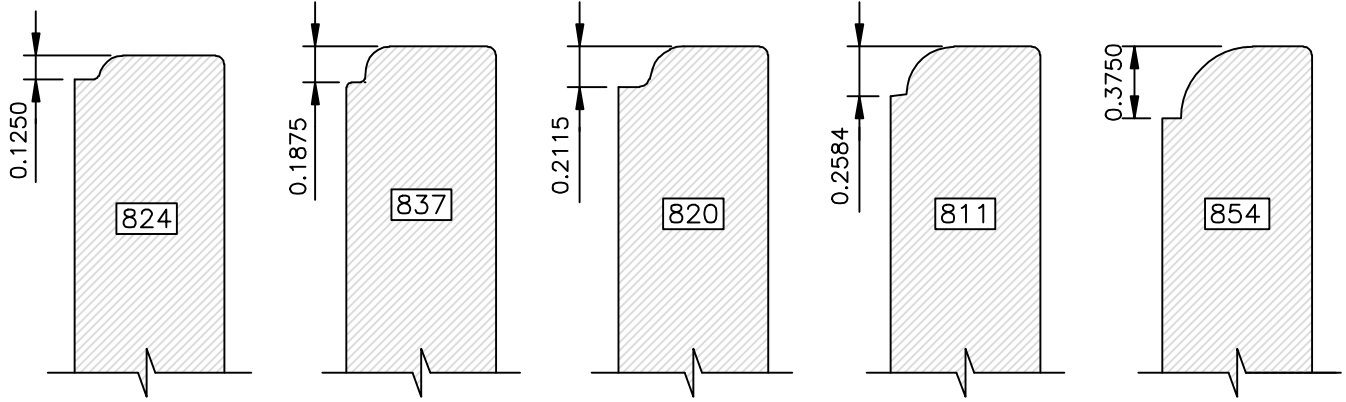

DRAWINGS ARE TO SCALE

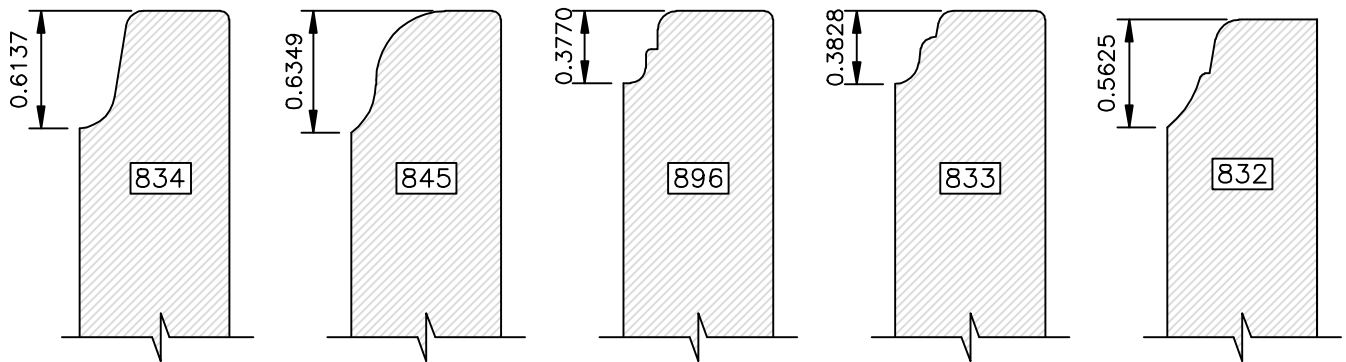
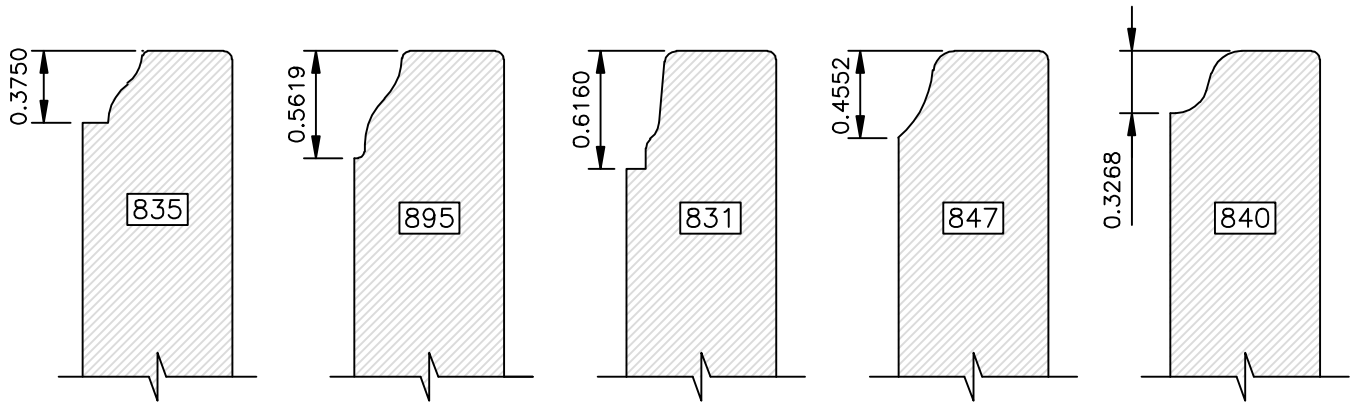

Go West!

MATCHING OUTSIDE EDGE PROFILES

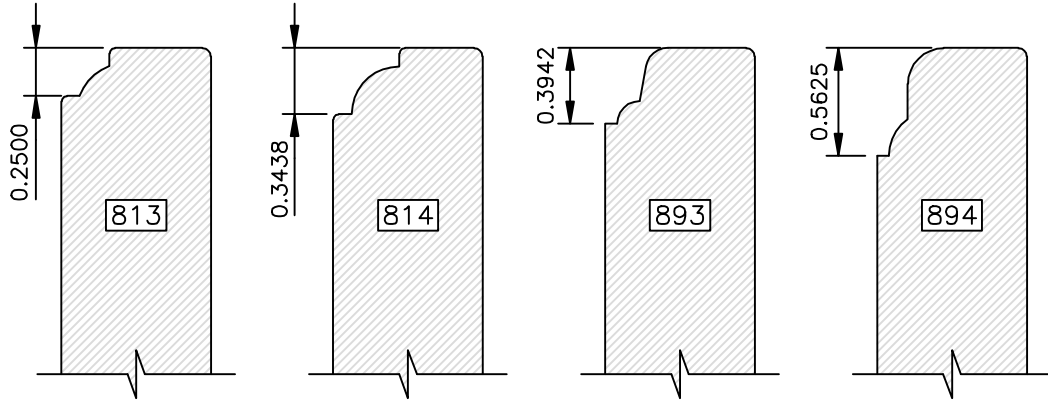

DRAWINGS ARE TO SCALE

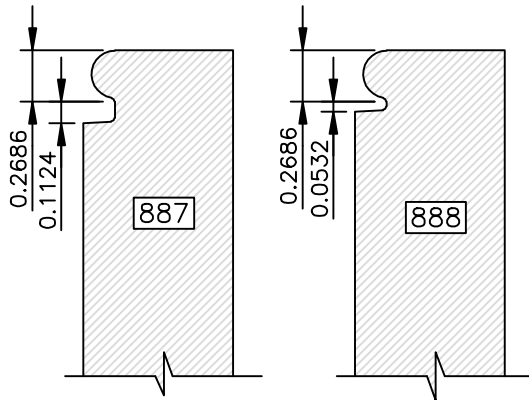

S4S STYLES

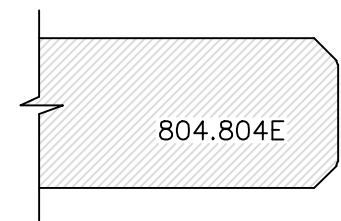
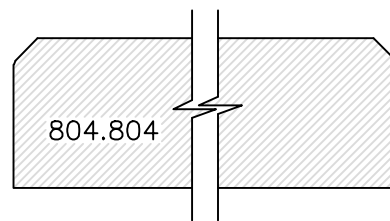
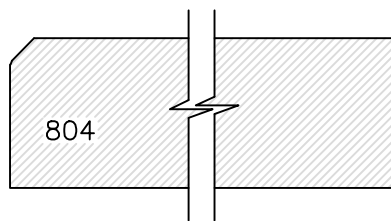

Alder-Rustic ~ This unique species may have many contrasts. Color variations may range from light tan to reddish brown. There will be wide range of rustic characteristics, knots, mineral, and some checking. All materials will be structurally sound, but some small knots may be open. Knot size and the amount of defects allowed cannot be specified by the customer.

Alder-Select ~ Normal characteristics of this species will be monitored under tighter guidelines than our standard product. This grade will be uniform in color and grain throughout. There may be very small amounts of mineral in the machined areas. This is a good product for natural to light stains.

Ash-Natural ~ The natural characteristics common to this product are standard, which results in a blend of sap wood and heartwood throughout the product. A small amount of mineral is allowed on the face and in the machined areas. This product would be best used with a medium to dark stain.

Ash-White ~ Normal characteristics of this species will be monitored under tight guidelines. This grade will be uniform in color and grain throughout. There may be very small amounts of mineral in the machined areas. This is a good product for natural to light stains.

Beech-European Natural ~ The common characteristics within this product will be allowed. The result of this mixture is a nice blend of light to medium color throughout. A small amount of mineral will be allowed on the face and in the machined areas. This product would be best used with a medium to dark stain.

Beech-European Rustic ~ This unique species may have many contrasts. Color variations may range from light tan to reddish brown. There will be wide range of rustic characteristics, knots, mineral, and some checking. All materials will be structurally sound, but some small knots may be open. Knot size and the amount of defects allowed cannot be specified by the customer.

Beech-European Select ~ Normal characteristics of this species will be monitored under tighter guidelines than our standard product. This grade will be uniform in color and grain throughout. There may be very small amounts of mineral in the machined areas. This is a good product for natural to light stains.

Birch-Natural ~ The natural characteristics common to this product are standard, which results in a blend of sap wood and heartwood throughout the product. A small amount of mineral is allowed on the face and in the machined areas. This product would be best used with a medium to dark stain.

Birch-Red ~ Normal characteristics of this species will be monitored under tighter guidelines than our standard product. This grade will be uniform in color and grain and will have a reddish tan color. There may be very small amounts of mineral in the machined areas. This is a good product for natural to light stains.

Birch-Rustic Red ~ This unique species may have many contrasts. Color variations may range from sap wood to heartwood, but will be predominately heartwood. There will be wide range of rustic characteristics, knots, sapwood, mineral, and some checking. All materials will be structurally sound, but some small knots may be open. Knot size and the amount of defects or sap allowed cannot be specified by the customer.

Birch-White ~ Normal characteristics of this species will be monitored under tighter guidelines than our standard product. This grade will be uniform in color and grain and will be lighter than our natural product. There may be very small amounts of mineral in the machined areas. This is a good product for natural to light stains.

Butternut ~ The common characteristics within this product will be allowed. The result of this mixture is a nice blend of light to medium color throughout. A small amount of mineral will be allowed on the face and in the machined areas. This product would be best used with a medium to dark stain.

Cherry-Heritage ~ This product is somewhat unique. It has all the characteristics common to the species with its guidelines the same as the rustic grade. Large knots are not allowed in this grade, but plenty of bird peck, mineral, and small defects. This is a great product for someone wanting all the natural characteristics of the species without large knots.

Cherry-Natural ~ The common characteristics within this product will be allowed. The result of this mixture is a nice blend of light to medium color throughout. A small amount of mineral will be allowed on the face and in the machined areas. This product would be best used with a medium to dark stain.

Cherry-Rustic ~ This unique species may have many contrasts. Color variations may range from sap wood to deep red. There will be a wide range of rustic characteristics, knots, sapwood, mineral, and some checking. All materials will be structurally sound, but some small knots may be open. Knot size and the amount of defects or sap allowed cannot be specified by the customer.

Cherry-Select ~ Normal characteristics of this species will be monitored under tighter guidelines than our standard product. This grade will be uniform in color and grain throughout. There may be very small amounts of mineral in the machined areas. This is a good product for natural to light stains.

Hickory-Heritage ~ This product is somewhat unique. It has all the characteristics common to the species, with its guidelines the same as the rustic grade. Large knots are not allowed in this grade, but plenty of bird peck, mineral, and small defects. This is a great product for someone wanting all the natural characteristics of the species, without large knots.

Hickory-Natural ~ The natural characteristics common to this product are standard, which results in a blend of sapwood and heartwood throughout the product. A small amount of mineral is allowed on the face and in the machined areas.

Hickory-Rustic ~ This unique species may have many contrasts. Color variations may range from white to dark brown. There will be wide range of rustic characteristics, knots, sapwood, mineral, and some checking. All materials will be structurally sound, but some small knots may be open. Knot size and the amount of defects allowed cannot be specified by the customer.

Hickory-Select ~ Normal characteristics of this species will be monitored under tighter guidelines than our standard product. A mixture of sapwood and heartwood will be allowed and will be blended throughout. There may be very small amounts of mineral in the machined areas.

Mahogany-African ~ Normal characteristics of this species will be monitored under tight guidelines. This grade will be uniform in color and grain throughout. There may be very small amounts of mineral in the machined areas. This is a good product for natural to light stains.

Hard Maple-Rustic ~ This unique species may have many contrasts. Color variations may range from creamy white to medium brown. There will be a wide range of rustic characteristics, knots, sapwood, mineral, and some checking. All materials will be structurally sound, but some small knots may be open. Knot size and the amount of defects or sap allowed cannot be specified by the customer.

Hard Maple-White ~ Normal characteristics of this species will be monitored under tight guidelines. This grade will be uniform in color and grain throughout. There may be very small amounts of mineral in the machined areas. This is a good product for natural to light stains.

Paintgrade ~ This product may have small glue staves and color and grain match will not be considered in this grade. The species used in this product is manufacturers choice. In the selection of species for this product all panels will be the same and all frames will be the same. However, frames and panels may not necessarily be of the same species. This product is structurally sound and is suitable for painting.

Pine-Clear ~ The common characteristics within this product will be allowed. The result of this mixture is a blend of light sapwood to red heartwood throughout. A small amount of mineral will be allowed on the face and in the machined areas. There will be no knots in this grade.

Pine-Knotty ~ The common characteristics within this product will be allowed. The result of this mixture is a blend of light sapwood to red heartwood throughout. A small amount of mineral will be allowed on the face and in the machined areas. Knots will be structurally sound and may range in color from black to brownish red.

Poplar-Paintgrade ~ This product may have small glue staves, and color and grain match will not be considered in this grade. This product is structurally sound and is suitable for painting.

Poplar-Select ~ Normal characteristics of this species will be monitored under tighter guidelines than our standard product. A mixture of sapwood and heartwood will be allowed and will be blended throughout. There may be very small amounts of mineral in the machined areas.

Red Oak-Natural ~ The common characteristics within this product will be allowed. The result of this mixture is a nice blend of light to medium color throughout. A small amount of mineral will be allowed on the face and in the machined areas. This product would be best used with a medium to dark stain.

Red Oak-Quarter Sawn ~ This specie will follow the same guidelines as the Natural Red Oak, the only difference being in the way the lumber is cut at the sawmill. Quarter Sawn lumber is cut in such a way that the grain will have a straighter appearance and there will be flecks or “quarters” in the face of the product.

Red Oak-Rift Sawn ~ This specie will follow the same guidelines as the Natural Red Oak, the only difference being in the way the lumber is cut at the sawmill. Rift Sawn lumber is cut in such a way that the grain will have a straight, thin pencil line appearance.

Red Oak-Rustic ~ This unique species will have many contrasts allowed. Color variations may range from light tan to dark brown. There will be wide range of rustic characteristics, knots, sapwood, mineral and some checking. All materials will be structurally sound, but some small knots may be open. Knot size and the amount of defects or sap allowed cannot be specified by the customer.

Red Oak-Select ~ Normal characteristics of this specie will be monitored under tighter guidelines than our standard product. This grade will be uniform in color and grain and will be lighter than our natural product. There may be very small amounts of mineral in the machined areas. This is a good product for natural to light stains.

Soft Maple-Paintgrade ~ This product may have small glue staves, and color and grain match will not be considered in this grade. This product is structurally sound and is suitable for painting.

Soft Maple-White ~ Normal characteristics of this specie will be monitored under tight guidelines. This grade will be uniform in color and grain. There may be very small amounts of mineral in the machined areas. This is a good product for natural to light stains.

Soft Maple-Wormy ~ This unique species will have many contrasts allowed. Color variations may range from white to reddish brown, with worm holes, streaking and discoloration. All materials will be structurally sound, but worm holes will be open. The number of worm holes and streaking allowed cannot be specified by the customer.

Walnut-Natural ~ The common characteristics within this product will be allowed. The result of this mixture is a light sapwood to dark heartwood throughout. A small amount of mineral will be allowed on the face and in the machined areas. This product would be best used with a medium to dark stain.

Walnut-Premium ~ Normal characteristics of this specie will be monitored under tighter guidelines than our standard product. This grade will be uniform in color and grain throughout. There may be very small amounts of mineral in the machined areas. This is a good product for natural to light stains.

Walnut-Rustic ~ This unique species will have many contrasts allowed. Color variations will be kept to a minimum, but small amounts of sap are allowed in this grade. There will be wide range of rustic characteristics, knots, sapwood, mineral and some checking. All materials will be structurally sound, but some small knots may be open. Knot size and the amount of defects or sap allowed cannot be specified by the customer.

White Oak-Natural ~ The common characteristics within this product will be allowed. The result of this mixture is a nice blend of light to medium color throughout. A small amount of mineral will be allowed on the face and in the machined areas. This product would be best used with a medium to dark stain.

White Oak-Quarter Sawn ~ This specie will follow the same guidelines as the Natural Red Oak, the only difference being in the way the lumber is cut at the sawmill. Quarter Sawn lumber is cut in such a way that the grain will have a straighter appearance and there will be flecks or “quarters” in the face of the product.

White Oak-Rift Sawn ~ This specie will follow the same guidelines as the Natural Red Oak, the only difference being in the way the lumber is cut at the sawmill. Rift Sawn lumber is cut in such a way that the grain will have a straight, thin pencil line, appearance.

White Oak-Rustic ~ This unique species will have many contrasts allowed. Color variations may range from light tan to dark brown. There will be wide range of rustic characteristics, knots, sapwood, mineral and some checking. All materials will be structurally sound, but some small knots may be open. Knot size and the amount of defects or sap allowed cannot be specified by the customer.

White Oak-Select ~ Normal characteristics of this specie will be monitored under tighter guidelines than our standard product. This grade will be uniform in color and grain throughout. There may be very small amounts of mineral in the machined areas. This is a good product for natural to light stains.

WESTWIND

33645 United Ave. Pueblo, CO 81001, U.S.A.
Customer Service: **866.754.2275**
24 Hour Order Fax: **866.754.3955**
Order E-mail: **sales@westwindwood.net**

ORDER FORM for Molding

Quote Only

Date:

Job Name:

PO #:

Westwind Wood Office Use Only

Order Date:

Completion Date:

Job #:

Please Acknowledge Order By: Fax E-mail Mail

Company Name:	Contact Person:	
Mailing Address:	Phone #:	Fax #:
City/State/Zip:	E-mail:	
Shipping Address:		

	Lineal Footage	
Molding Profile:	Length Requirements	
Wood Species:	Grade: Select <input type="checkbox"/>	Rustic <input type="checkbox"/>
	Lineal Footage	
Molding Profile:	Length Requirements	
Wood Species:	Grade: Select <input type="checkbox"/>	Rustic <input type="checkbox"/>
	Lineal Footage	
Molding Profile:	Length Requirements	
Wood Species:	Grade: Select <input type="checkbox"/>	Rustic <input type="checkbox"/>

**DRAW OR TRACE CUSTOM
PROFILES IN THIS AREA**

Special Job Instructions:

Use Best Shipping Method

Preferred Shipping Method: Parcel

Our Truck Truckline Will Call

WESTWIND

33645 United Ave. Pueblo, CO 81001, U.S.A.
Customer Service: **866.754.2275**
24 Hour Order Fax: **866.754.3955**
Order E-mail: **sales@westwindwood.net**

ORDER FORM for Molding

Quote Only

Date:

Job Name:

PO #:

Westwind Wood Office Use Only

Order Date:

Completion Date:

Job #:

Please Acknowledge Order By: Fax E-mail Mail

Company Name:	Contact Person:	
Mailing Address:	Phone #:	Fax #:
City/State/Zip:	E-mail:	
Shipping Address:		

	Lineal Footage	
Molding Profile:	Length Requirements	
Wood Species:	Grade: Select <input type="checkbox"/>	Rustic <input type="checkbox"/>
	Lineal Footage	
Molding Profile:	Length Requirements	
Wood Species:	Grade: Select <input type="checkbox"/>	Rustic <input type="checkbox"/>
	Lineal Footage	
Molding Profile:	Length Requirements	
Wood Species:	Grade: Select <input type="checkbox"/>	Rustic <input type="checkbox"/>

**DRAW OR TRACE CUSTOM
PROFILES IN THIS AREA**

Special Job Instructions:

Use Best Shipping Method

Preferred Shipping Method: Parcel

Our Truck Truckline Will Call

Go West!

WESTWIND

— MANUFACTURERS OF —
DOORS, DRAWERS & MOLDING

719.466.4373 • WESTWINDWOOD.NET