

**Caution: Please verify panel thickness compatibility when ordering 701 or 701d.**

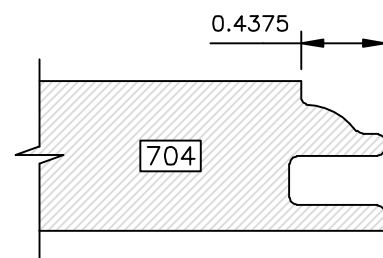

DRAWINGS ARE TO SCALE

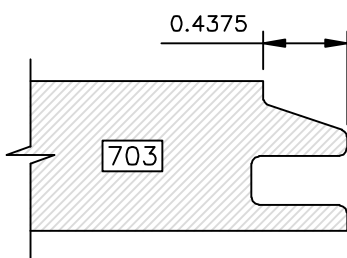

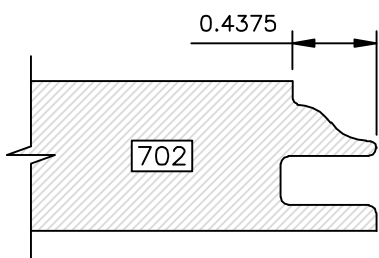
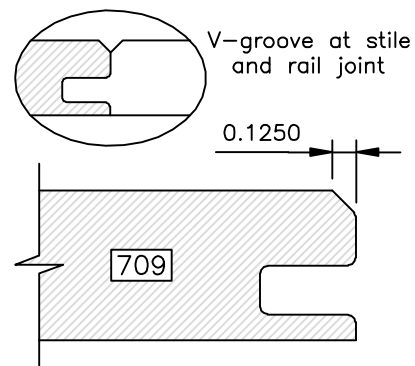
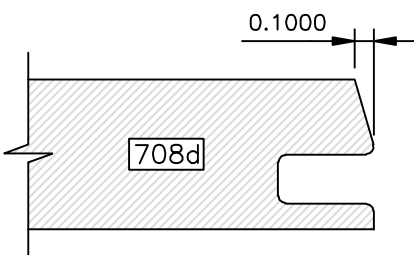
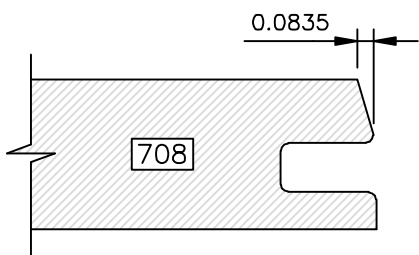
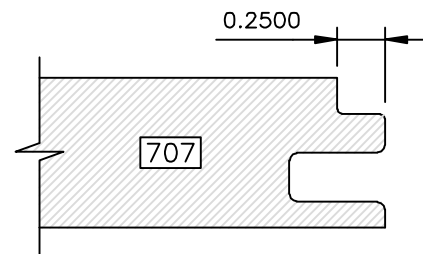
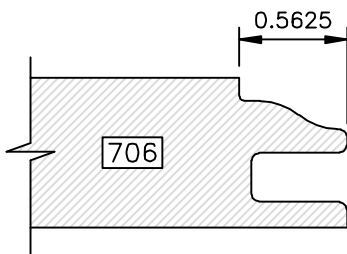
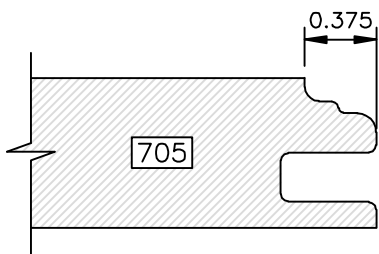
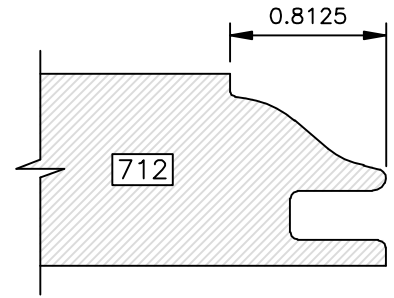
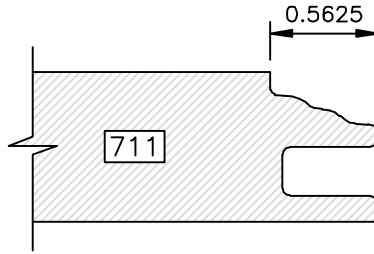
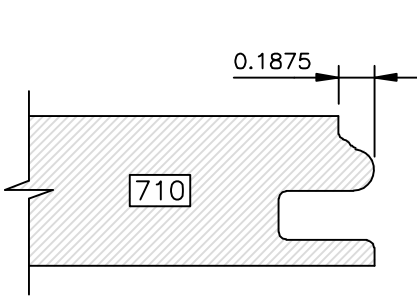

Available in 1" Thick Only

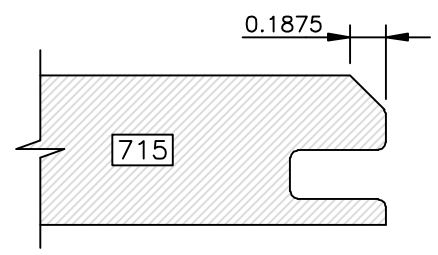
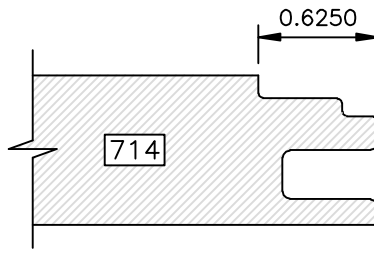
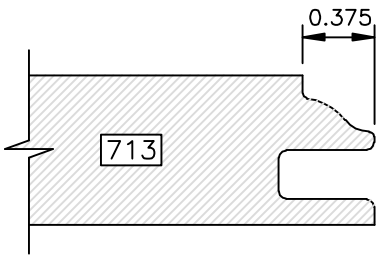

DRAWINGS ARE TO SCALE

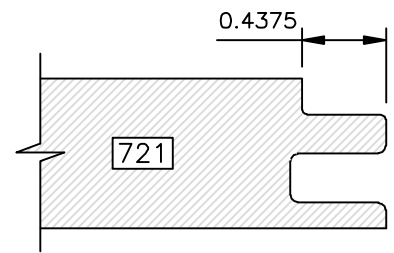
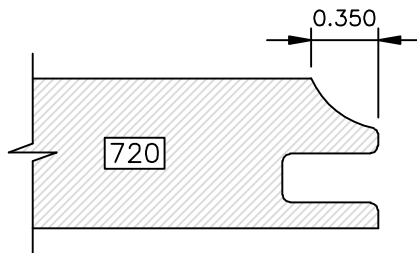
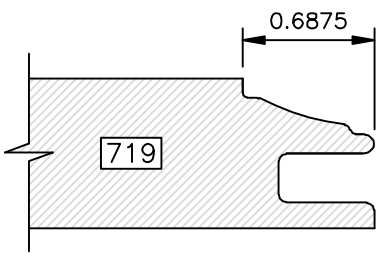
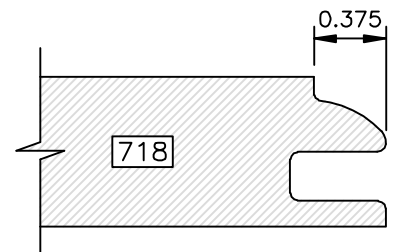
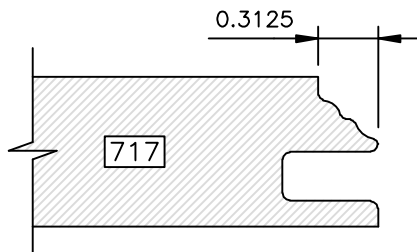
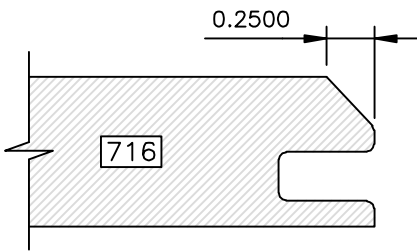

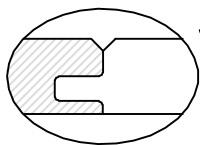

V-groove at stile  
and rail joint

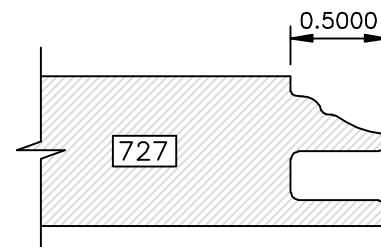
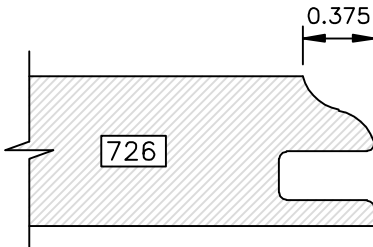
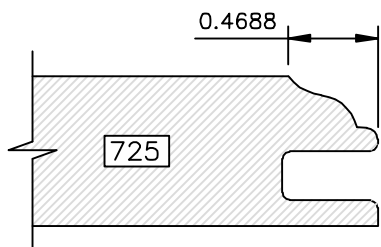
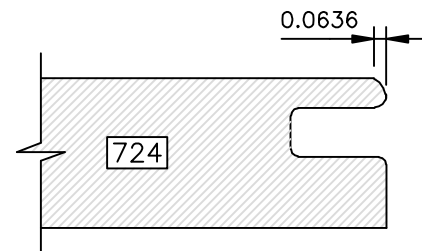
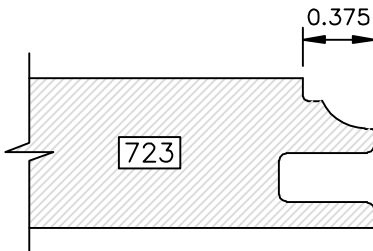
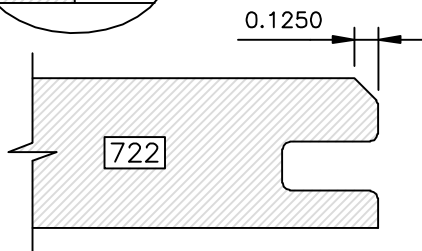

DRAWINGS ARE TO SCALE

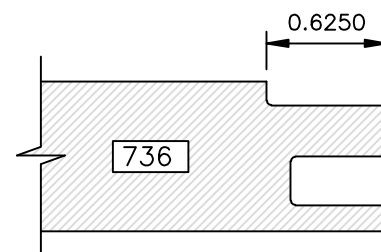
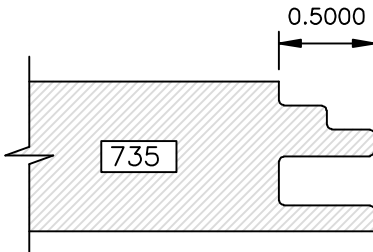
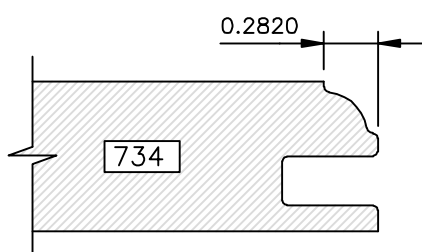
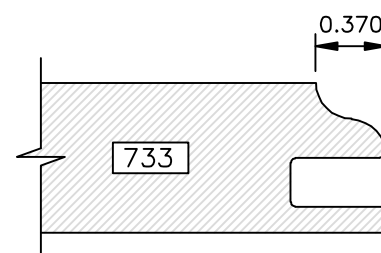
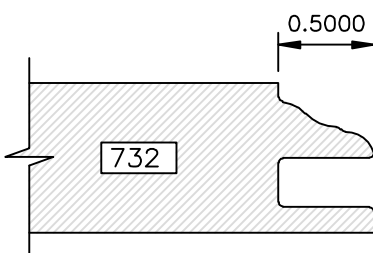
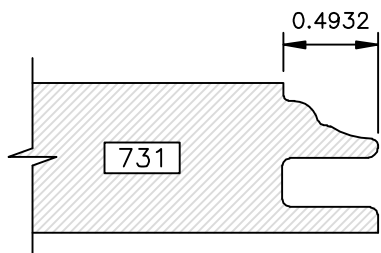

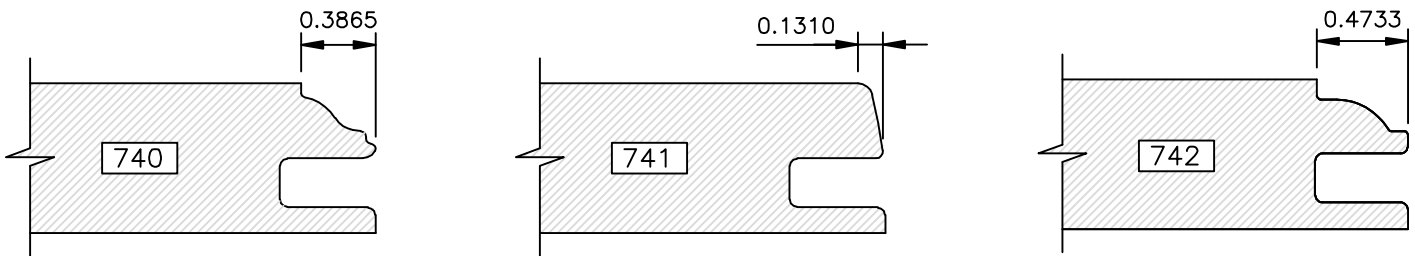
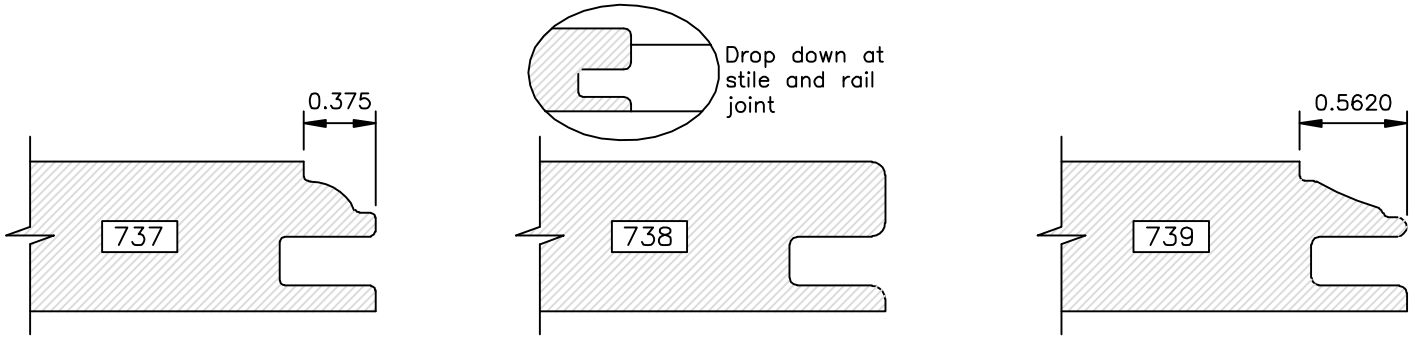

DRAWINGS ARE TO SCALE

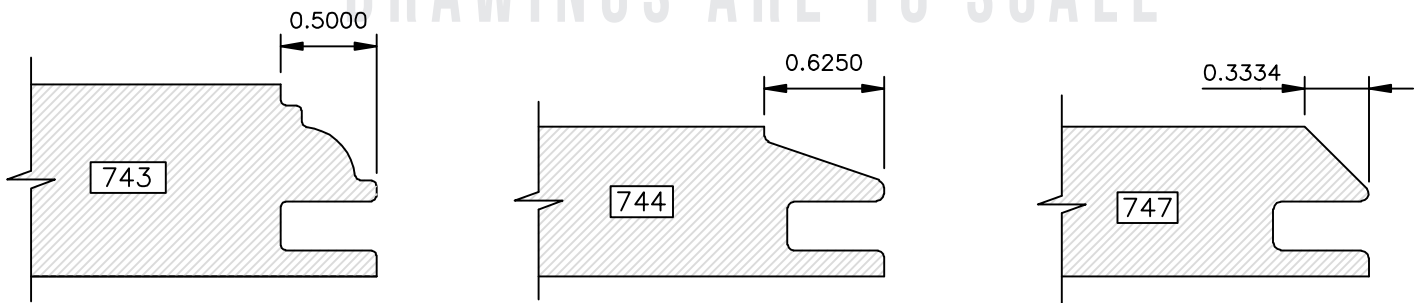

Available in 1" Thick Only

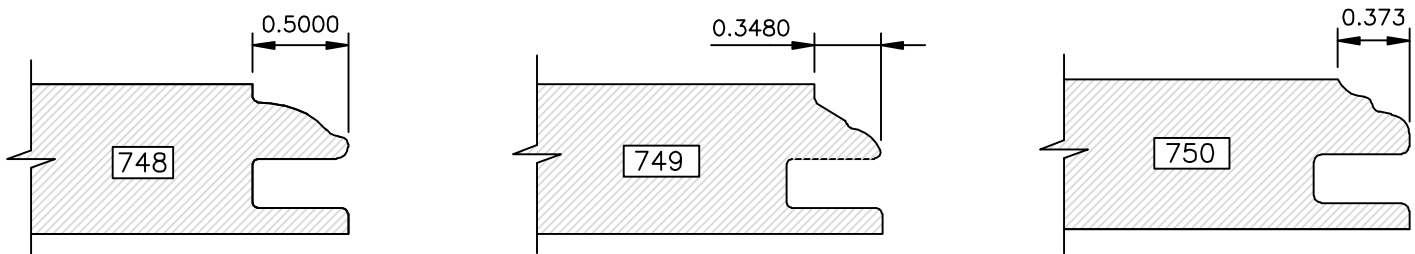

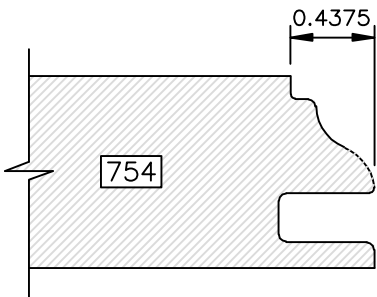
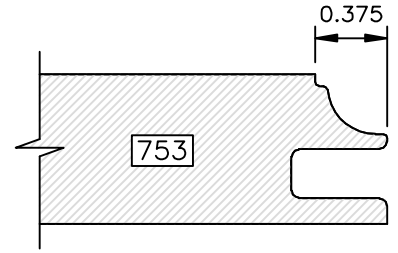
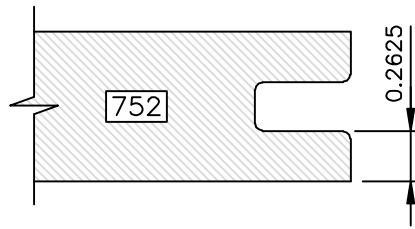
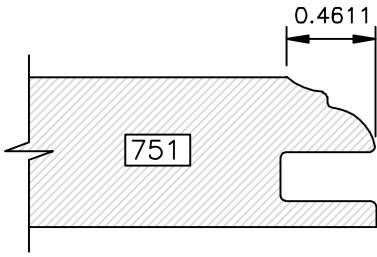

Available in 1" Thick Only

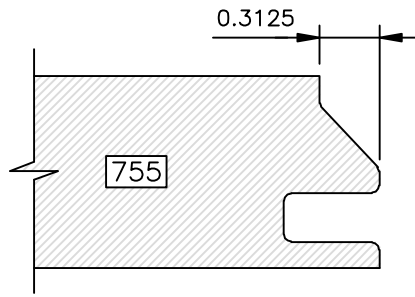

Available in 1" Thick Only

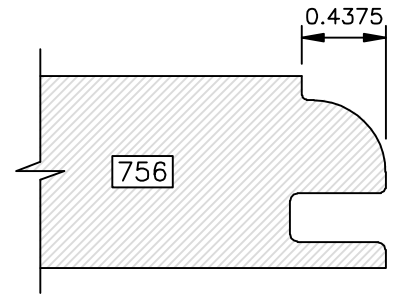

Available in 1" Thick Only

DRAWINGS ARE TO SCALE

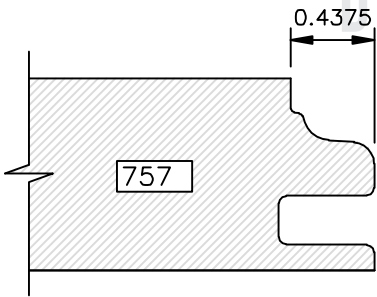

Available in 1" Thick Only

