

DRAWINGS ARE TO SCALE

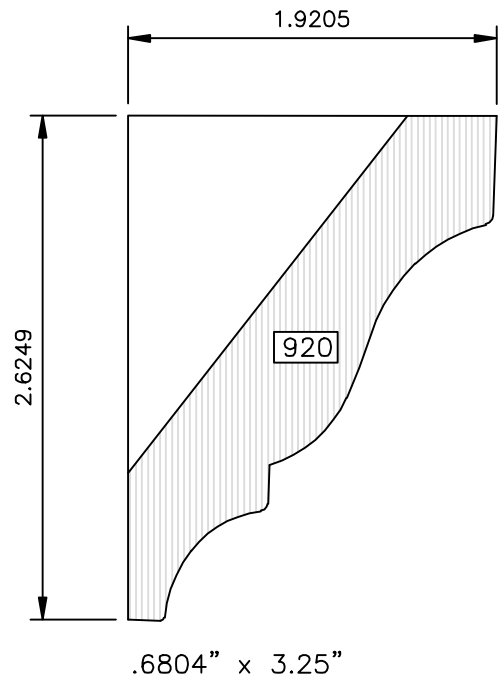

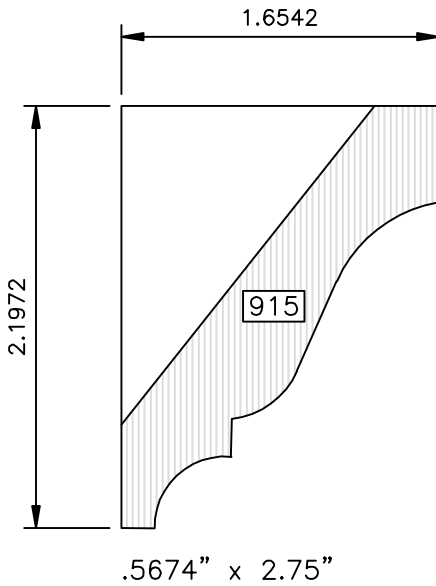

DRAWINGS ARE TO SCALE

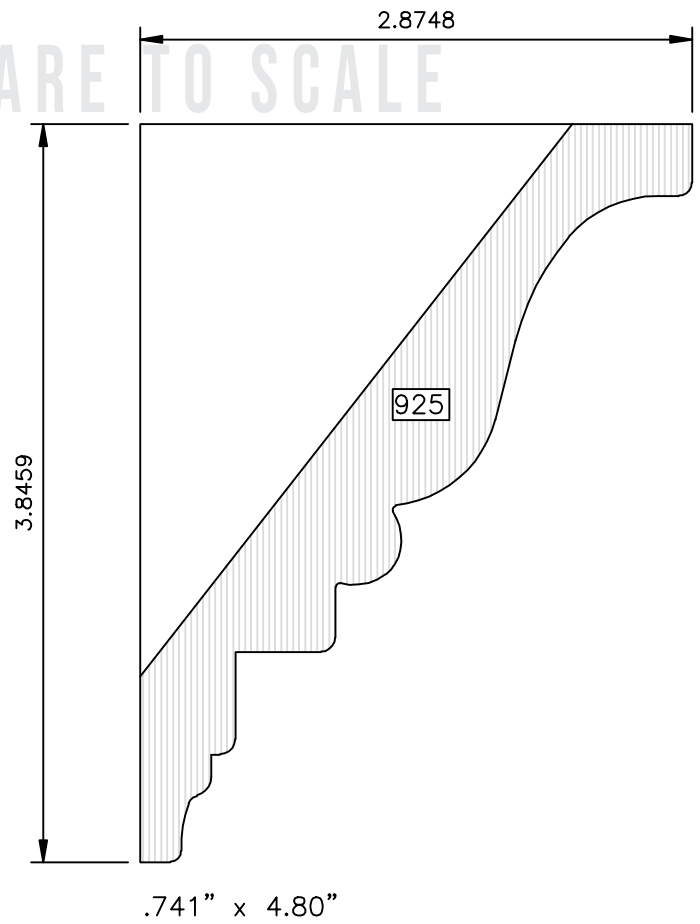
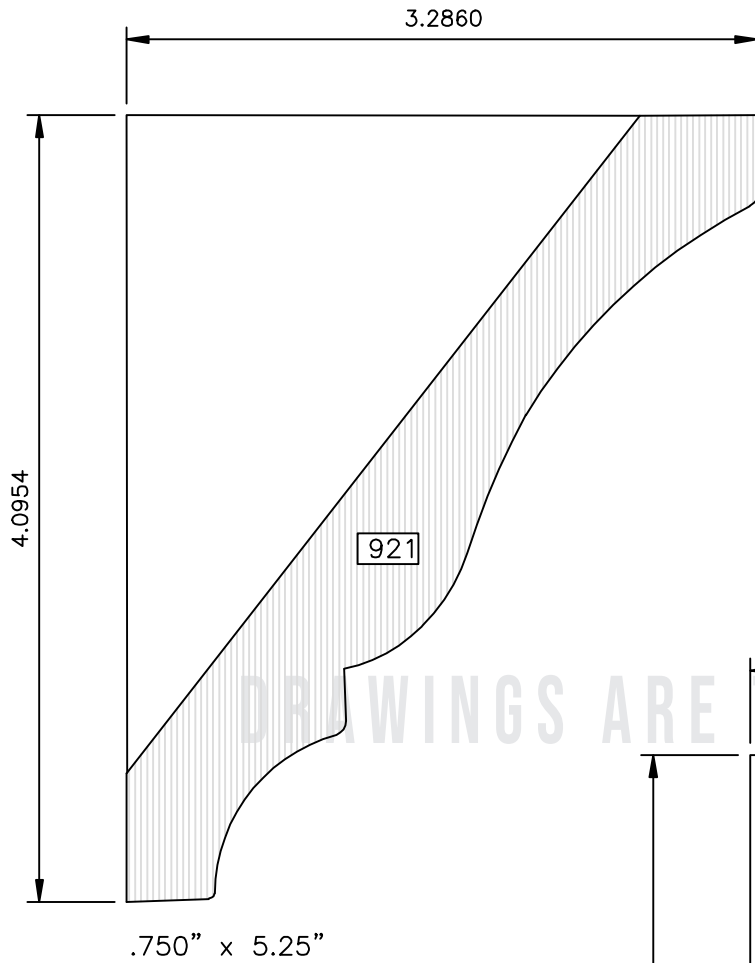
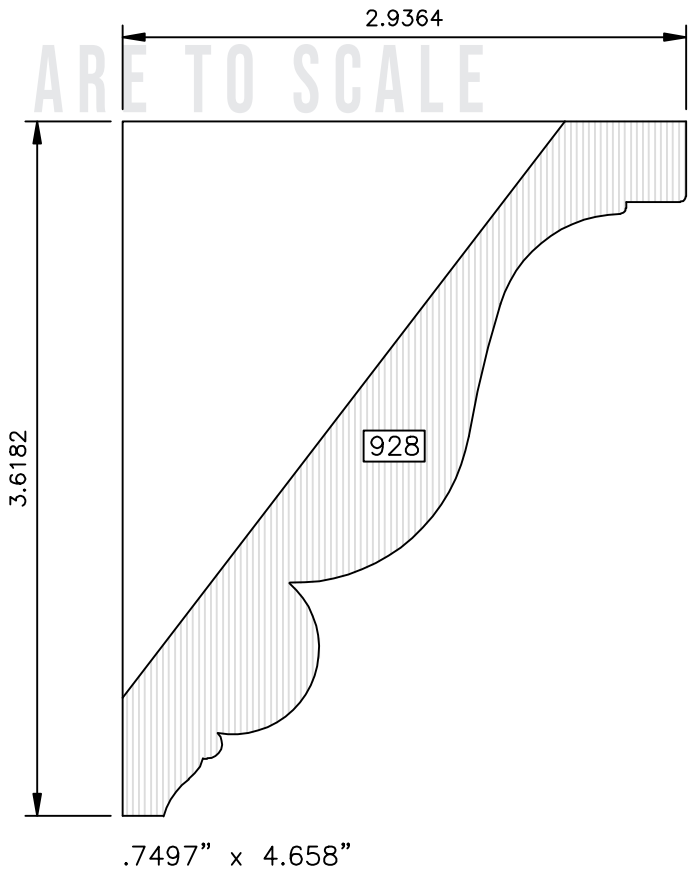
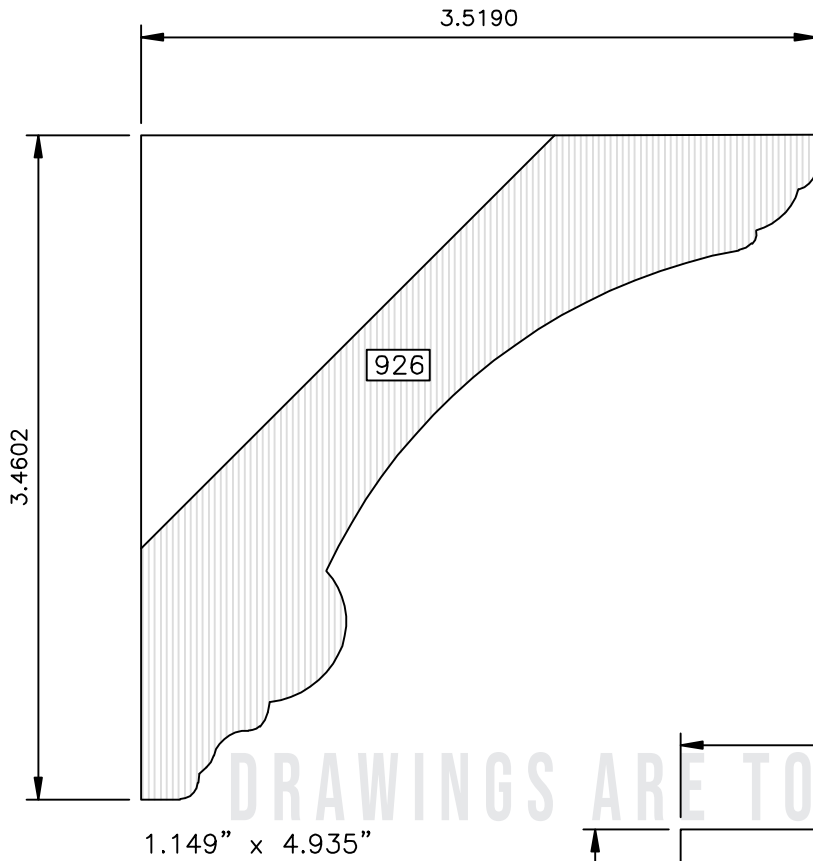

DRAWINGS ARE TO SCALE

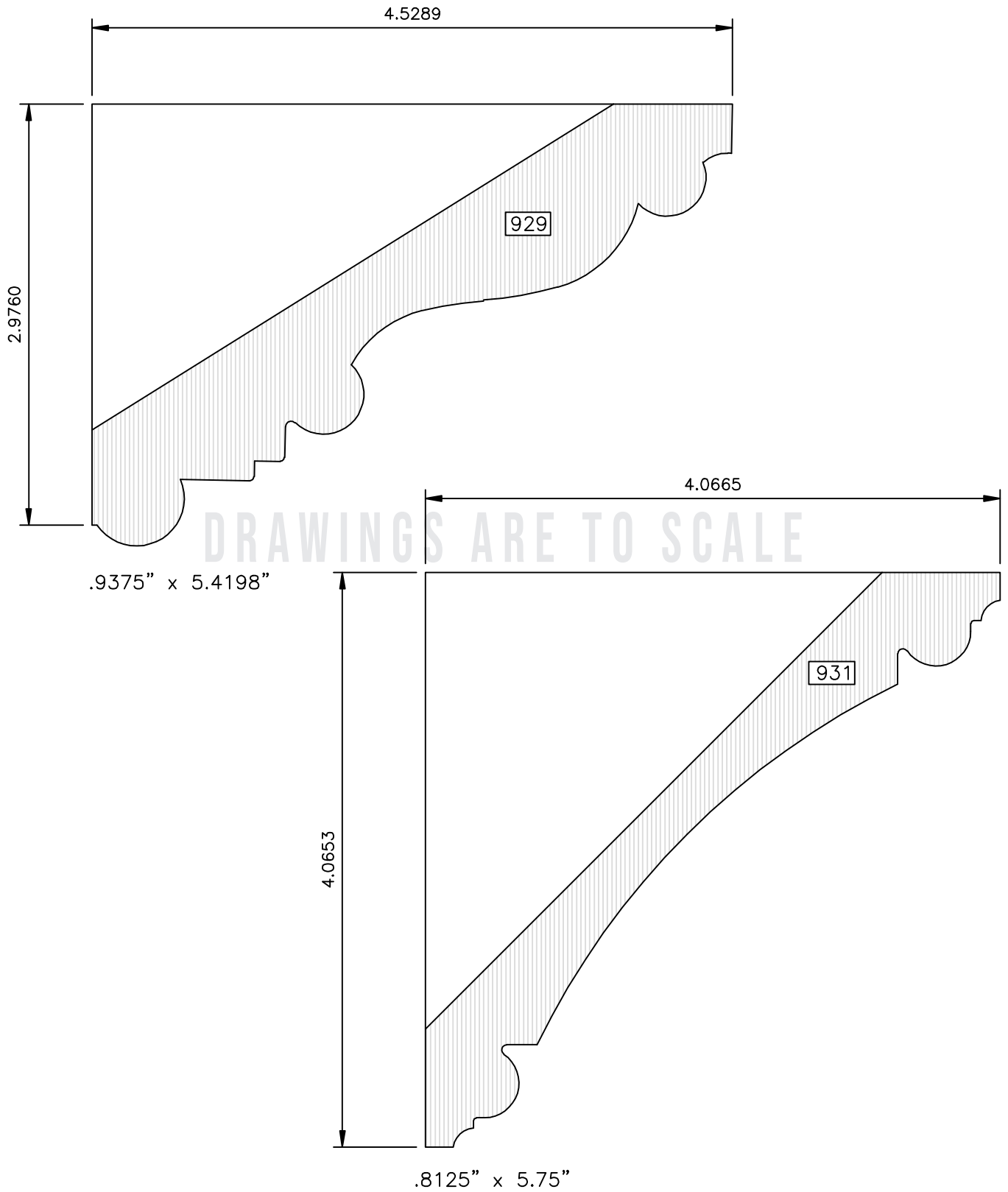

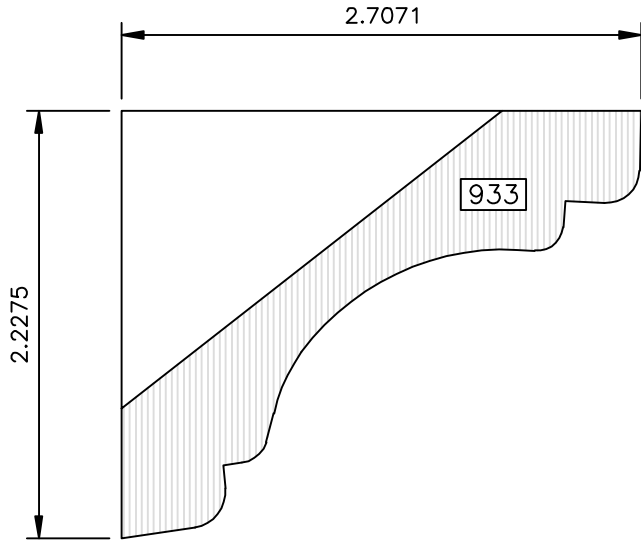

.7496" x 3.50"

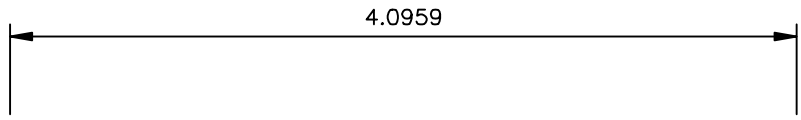

DRAWINGS ARE TO SCALE

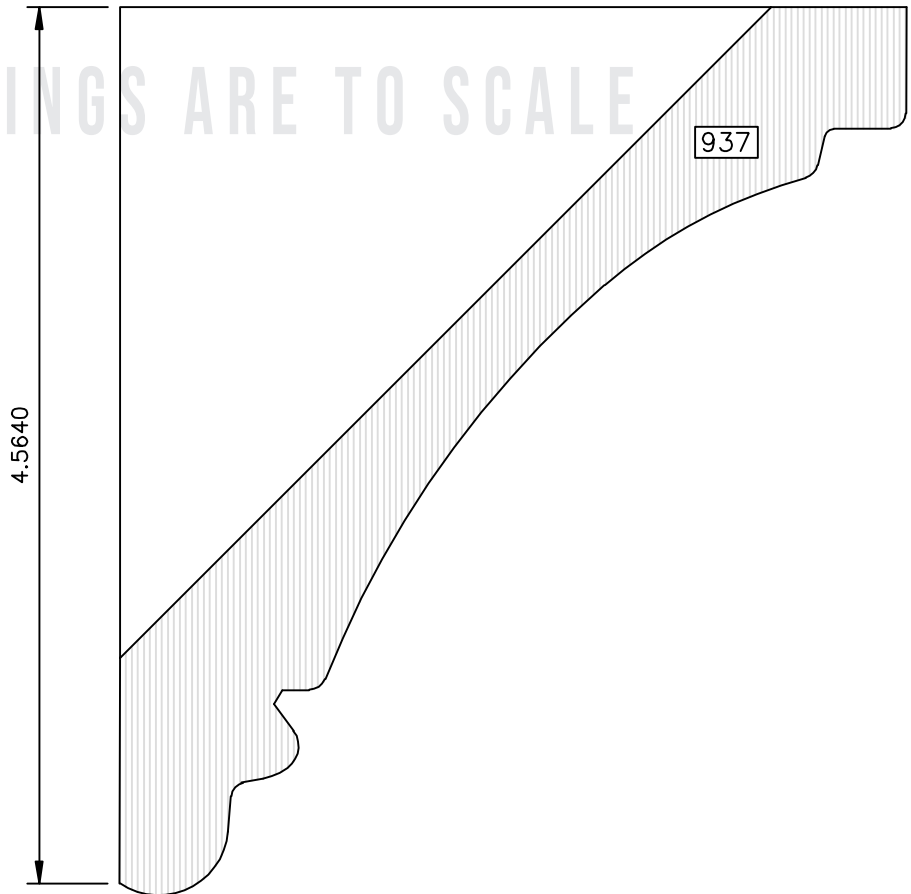

1.125" x 6.125"

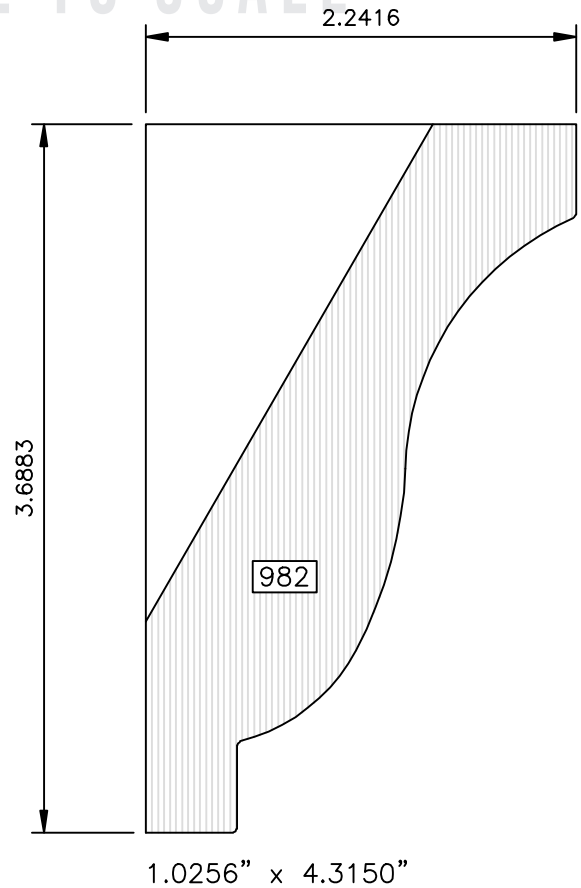
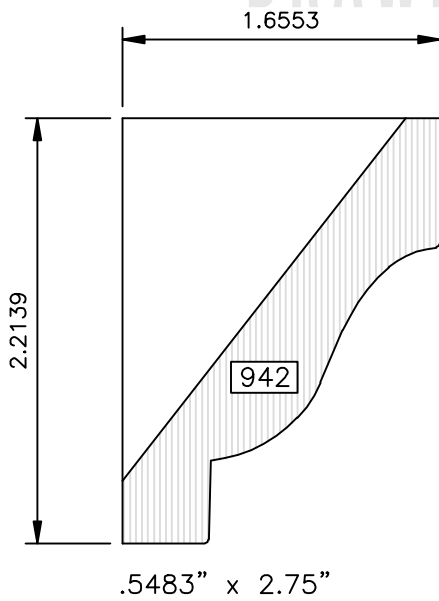
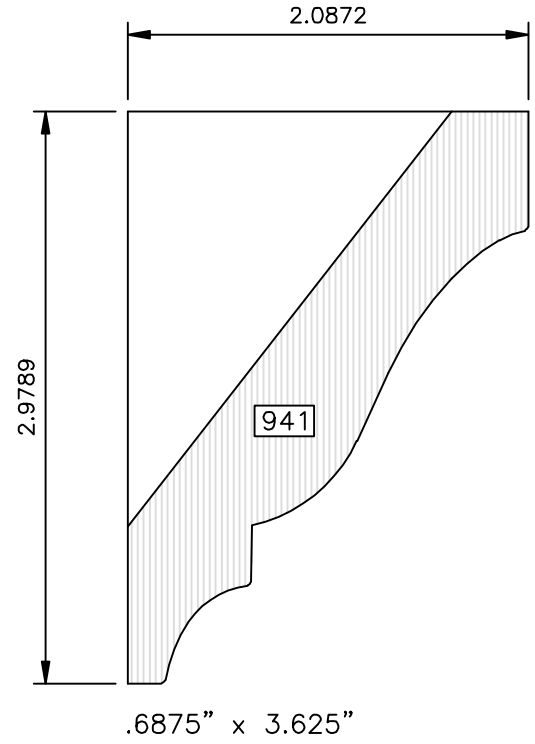
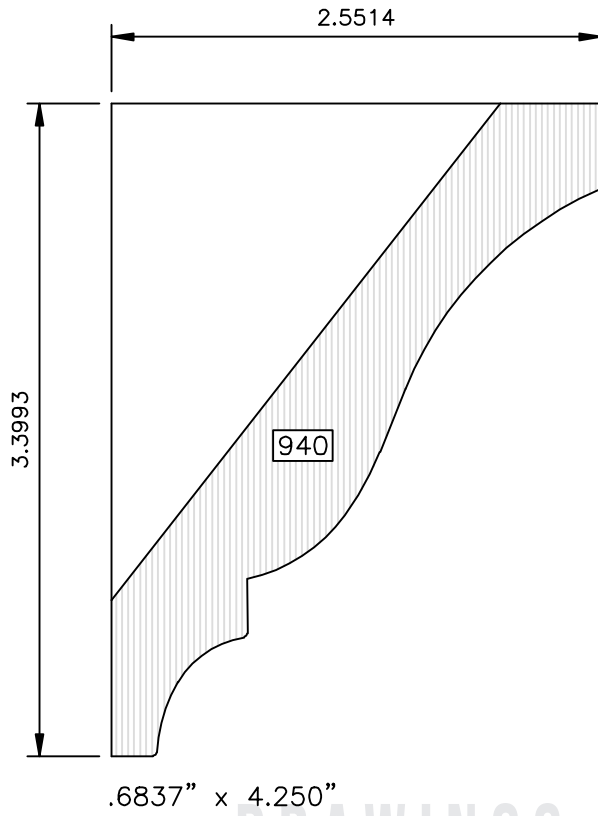

DRAWINGS ARE TO SCALE

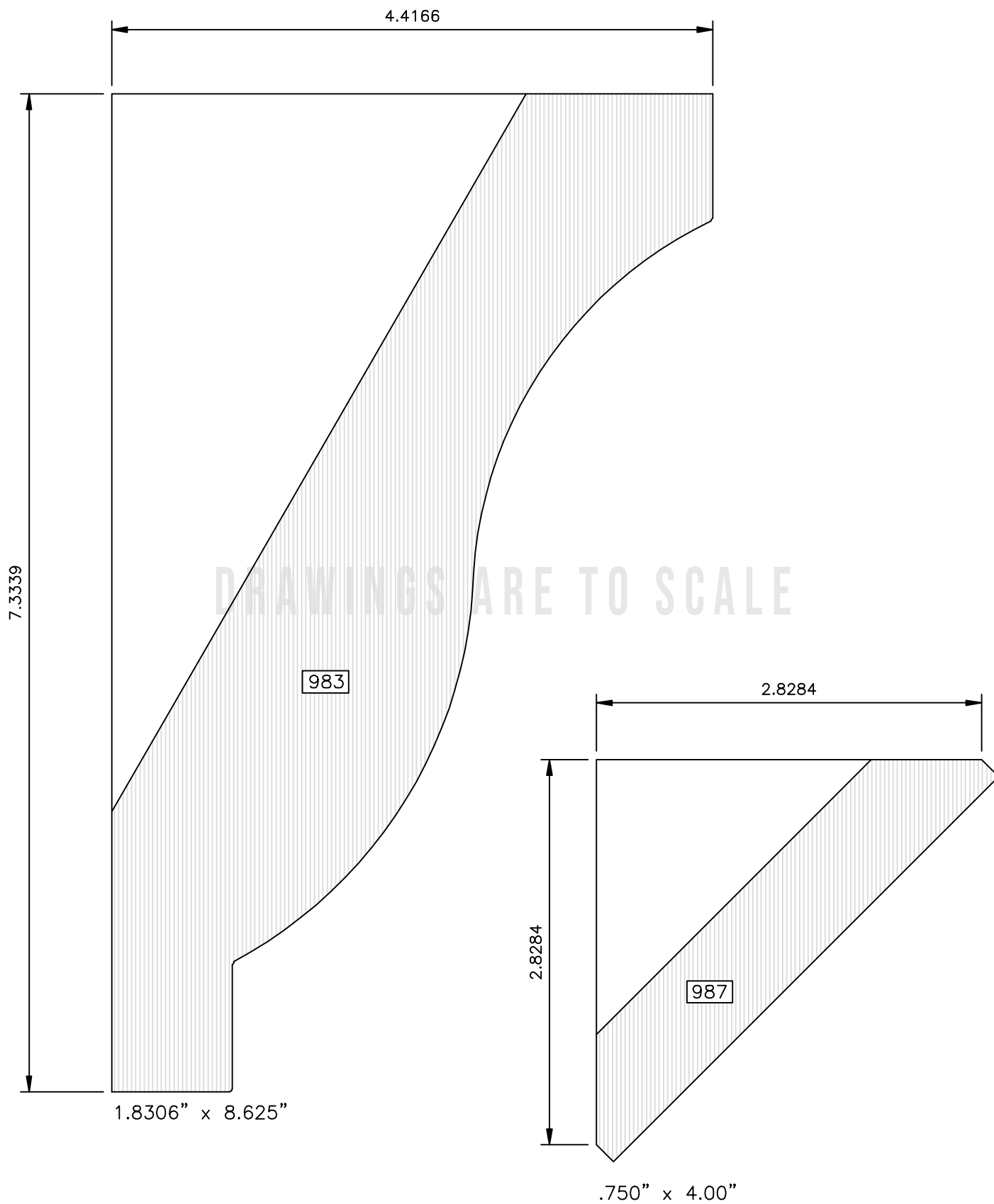

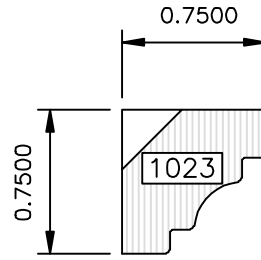
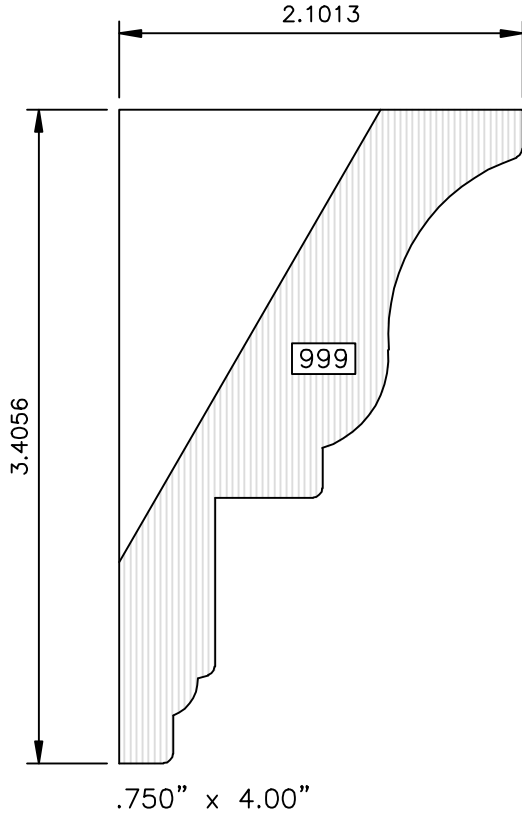

DRAWINGS ARE TO SCALE

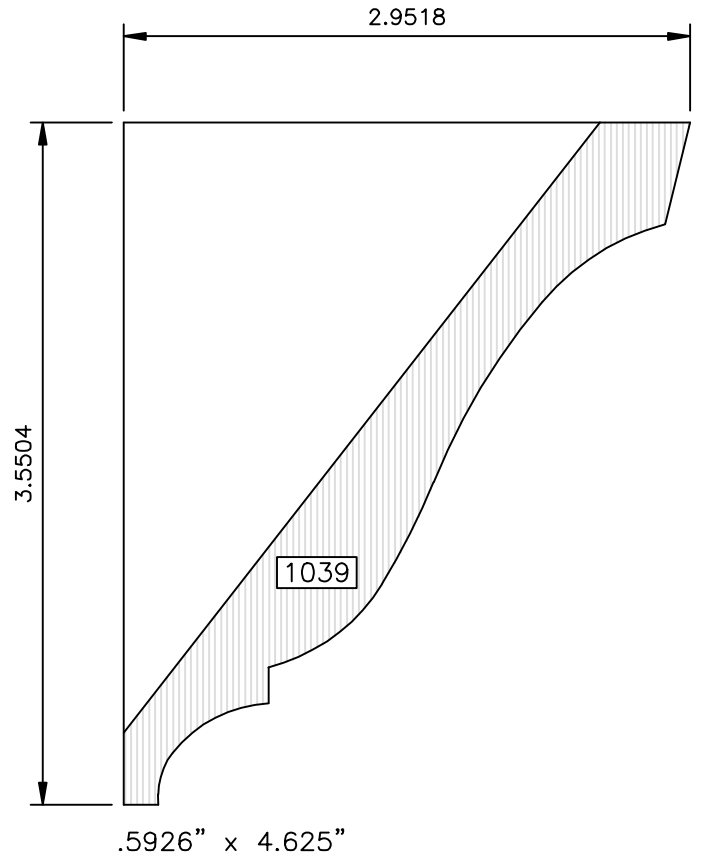
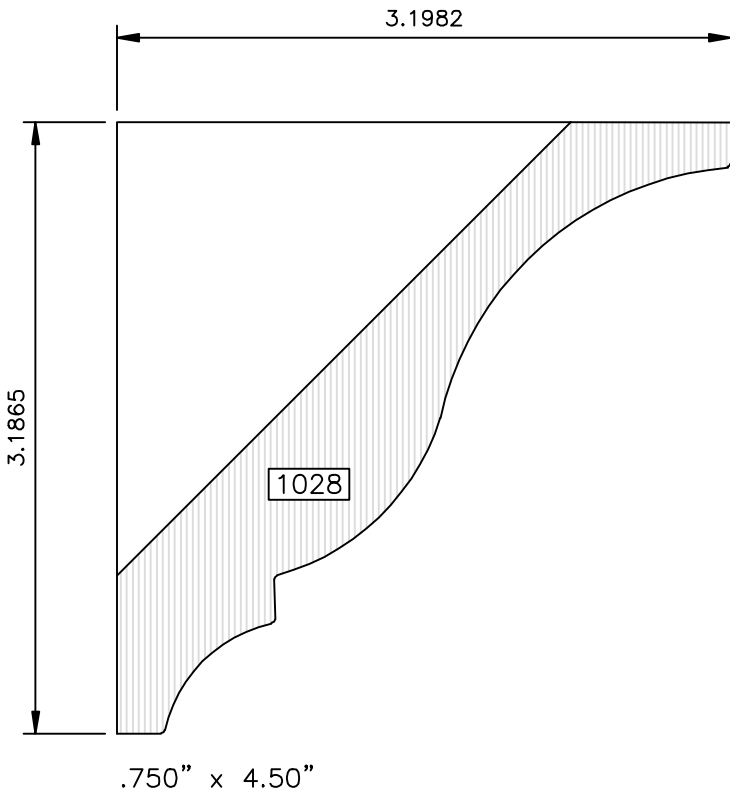



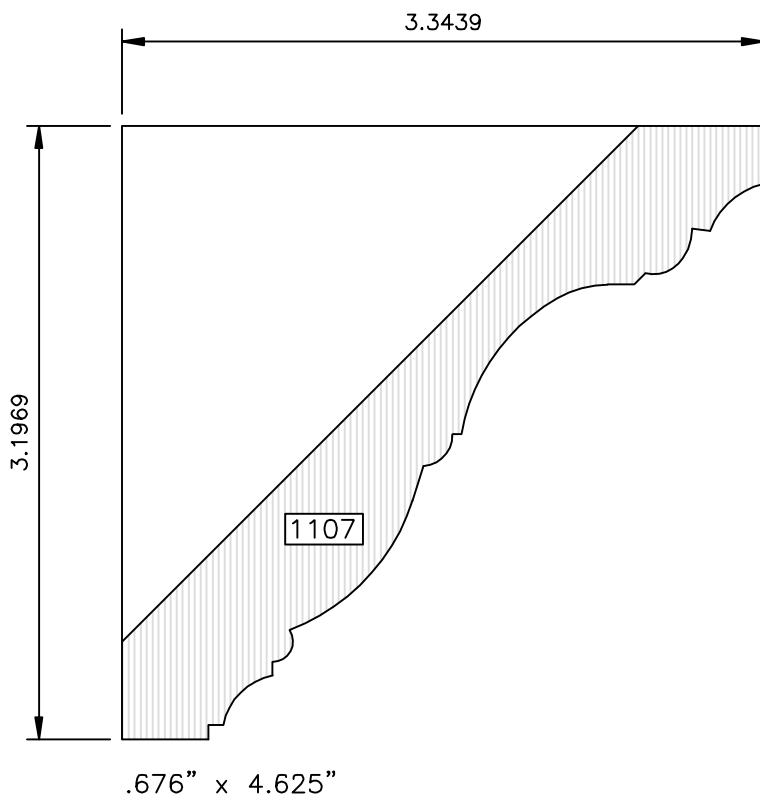
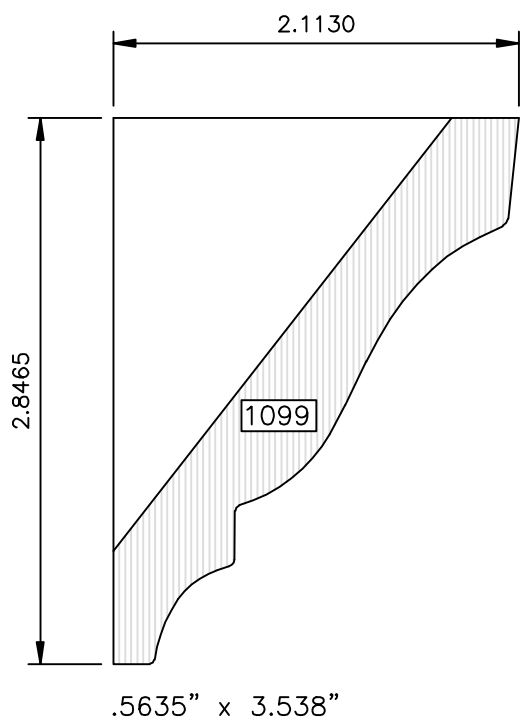

DRAWINGS ARE TO SCALE

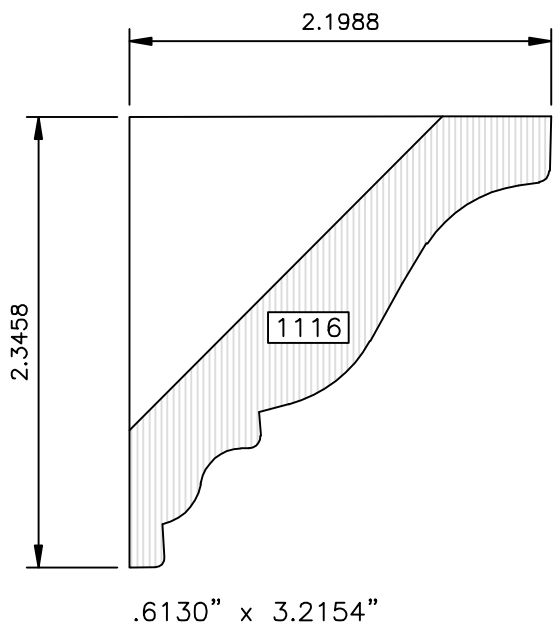

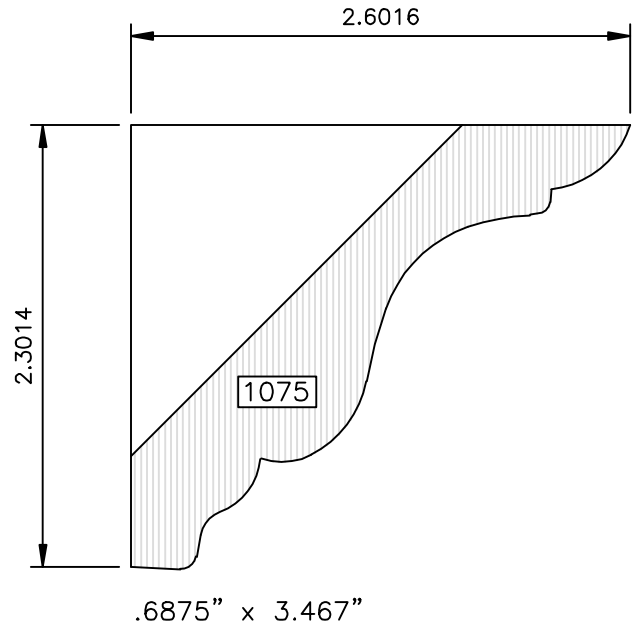
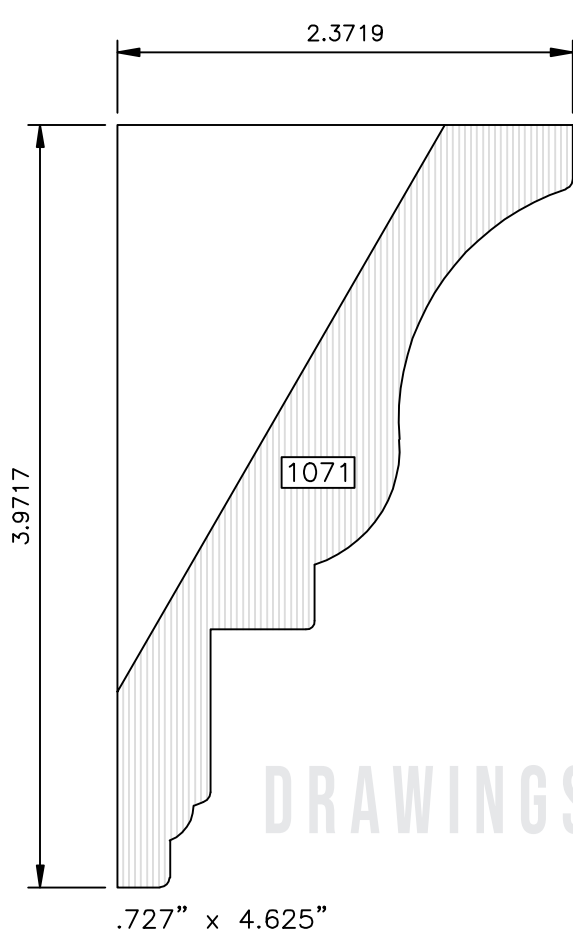

DRAWINGS ARE TO SCALE

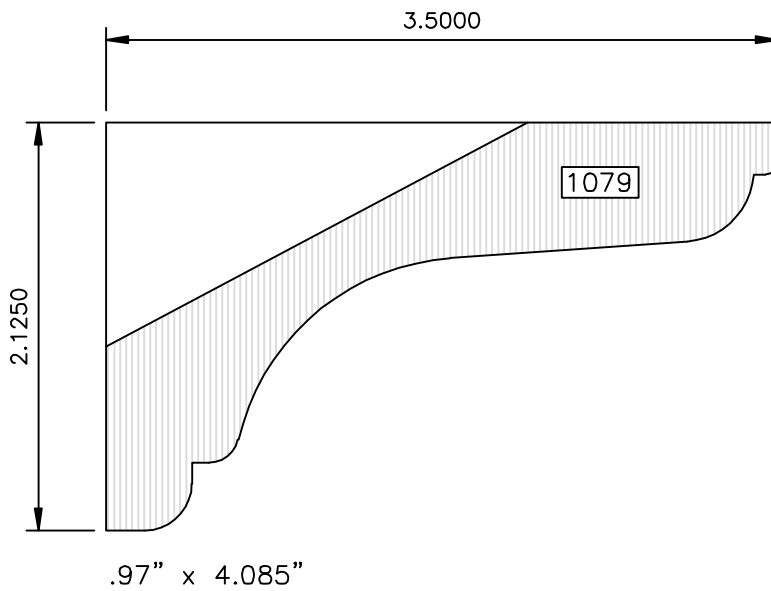

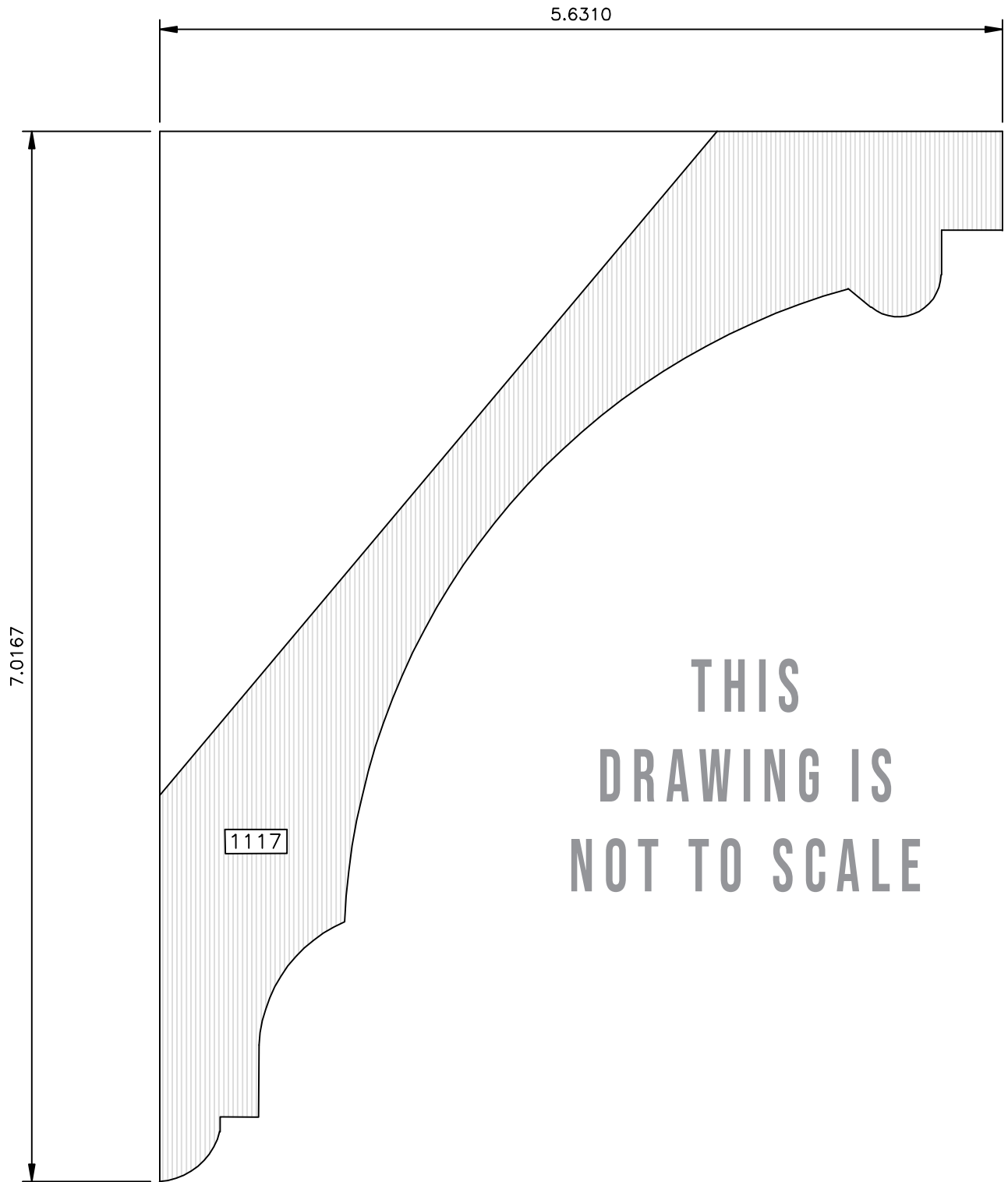

1.8877" x 8.999"

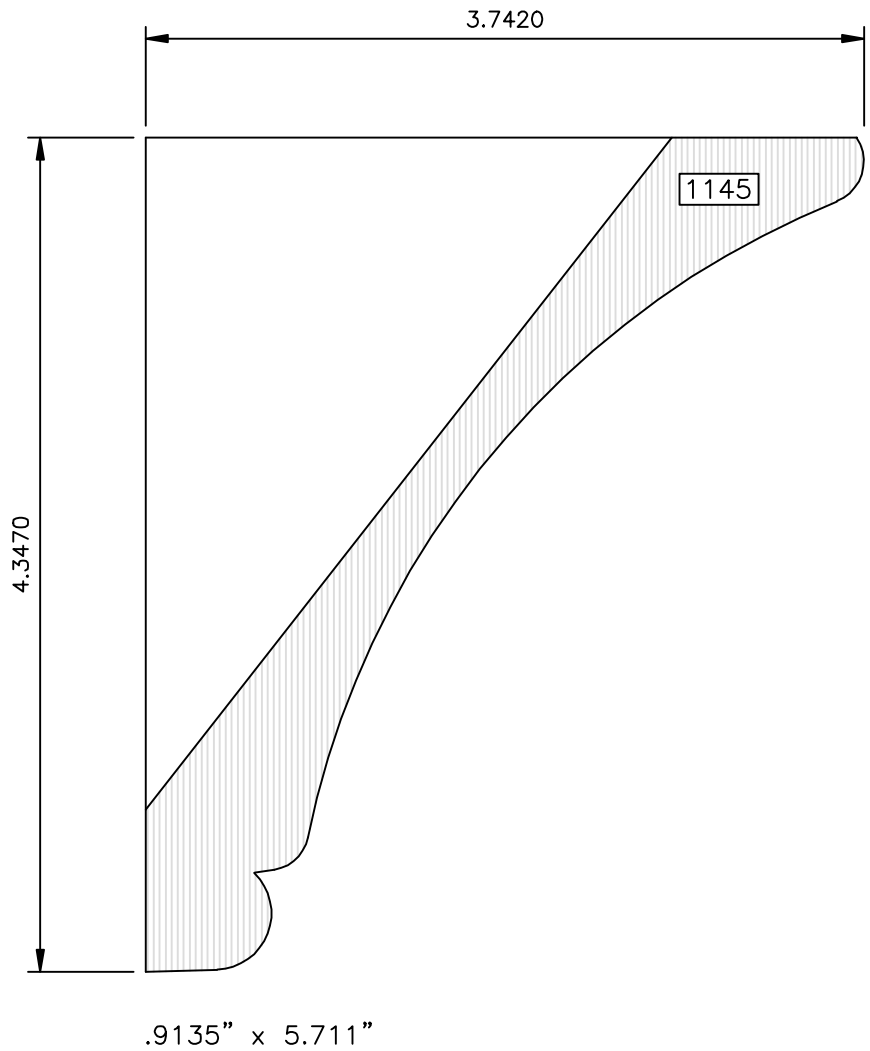
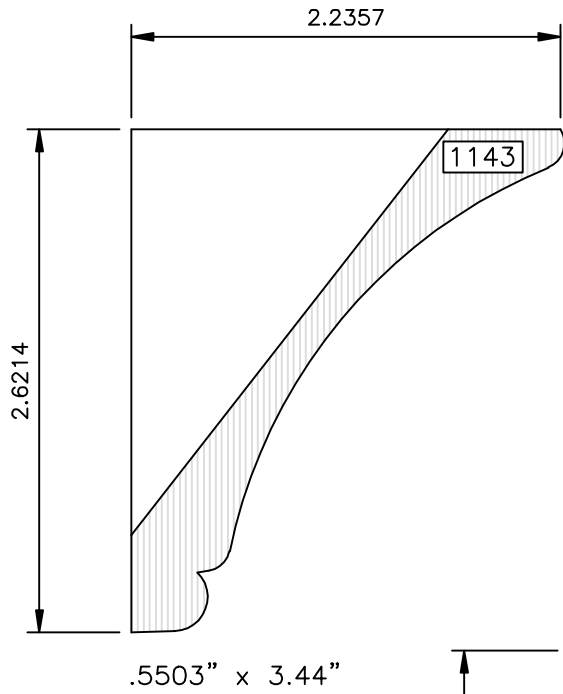

DRAWINGS ARE TO SCALE



DRAWINGS ARE TO SCALE