

APPLIED MOLDING STYLES

Go West!

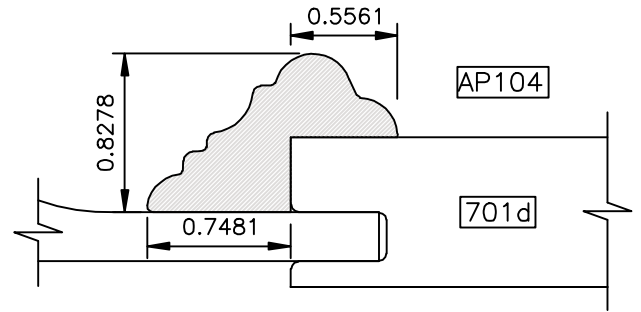

DRAWINGS ARE TO SCALE

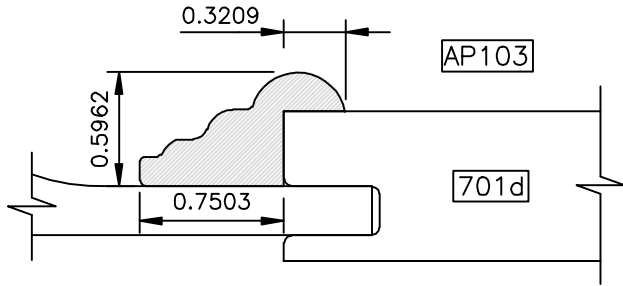
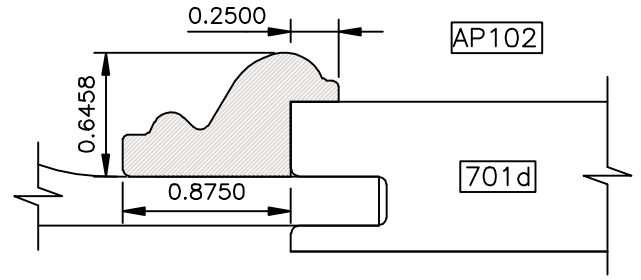
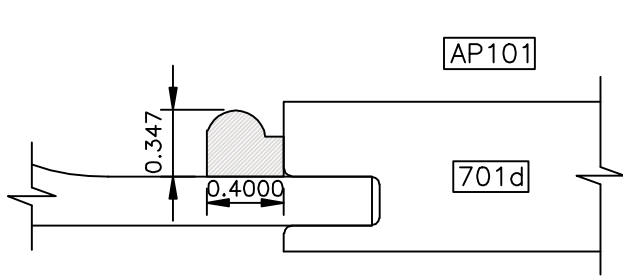
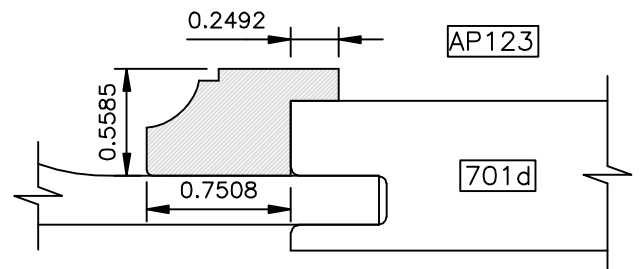
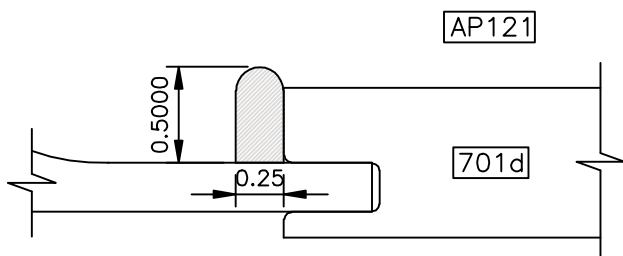
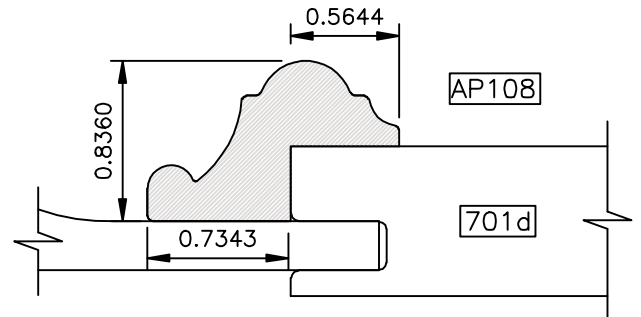
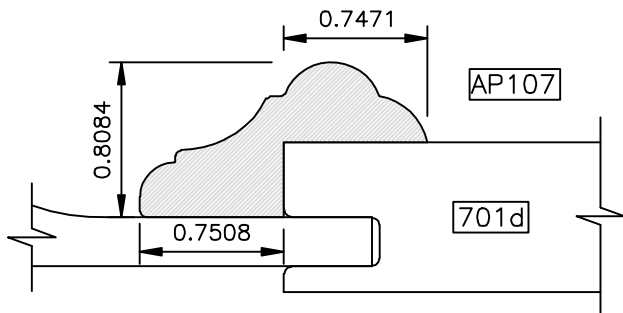
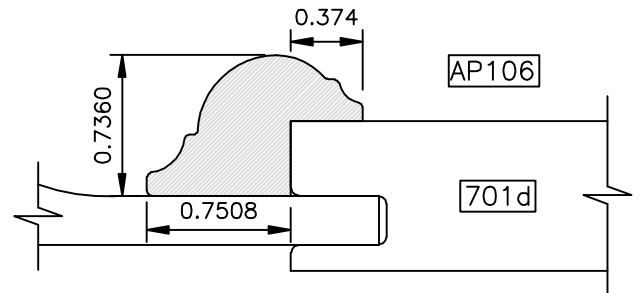
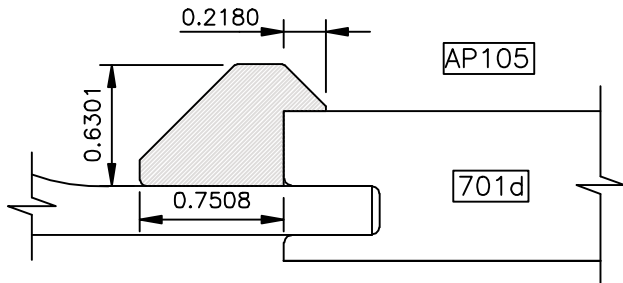

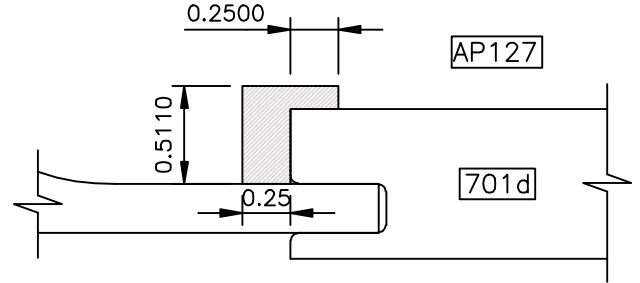
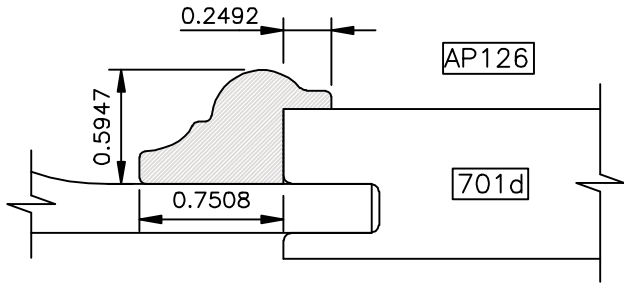
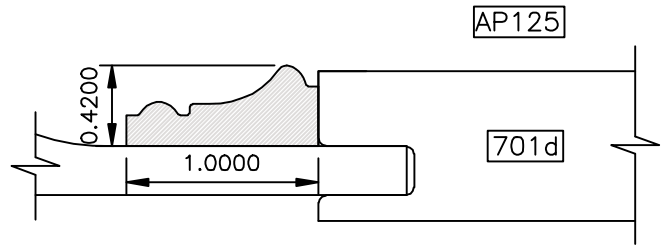
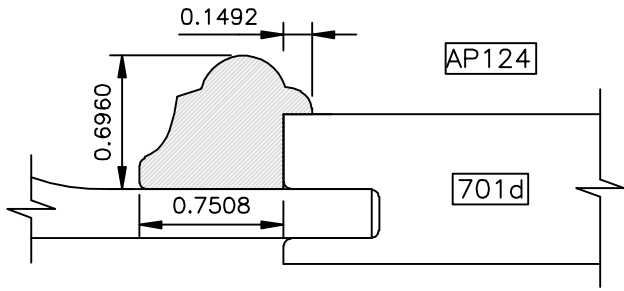

DRAWINGS ARE TO SCALE

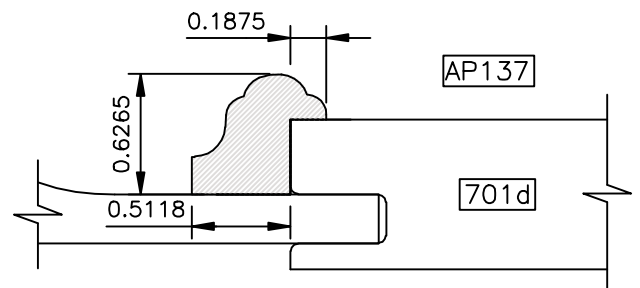
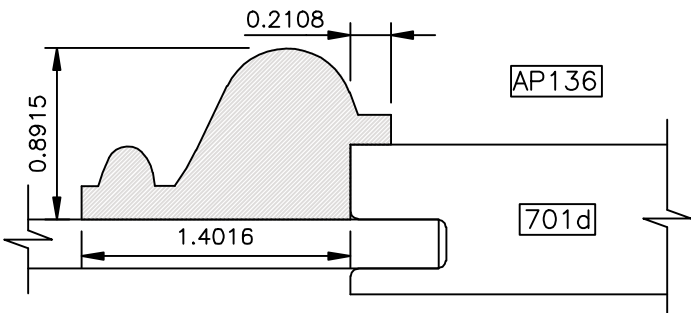
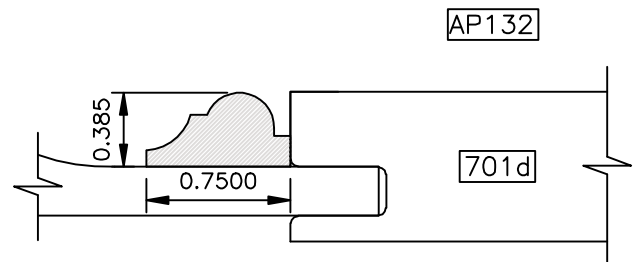
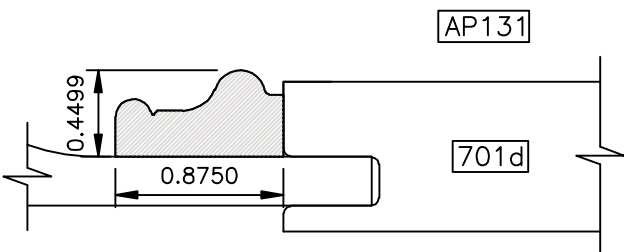
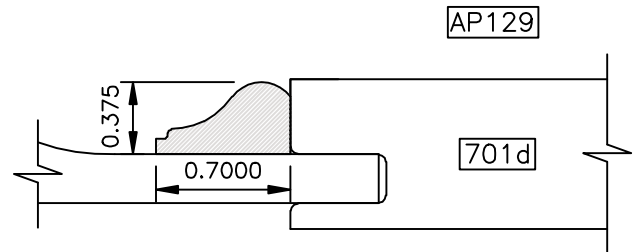
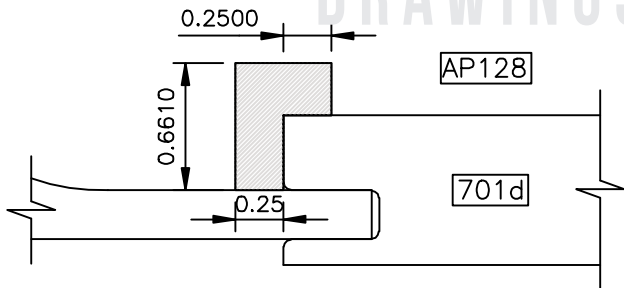

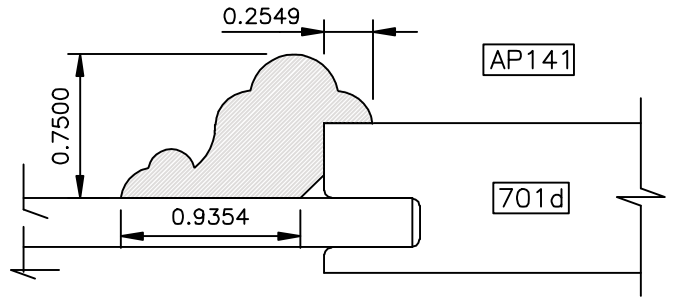
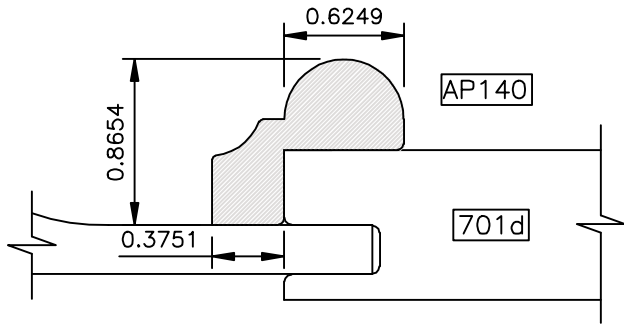
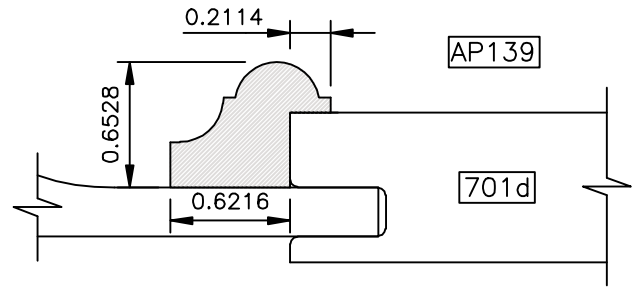
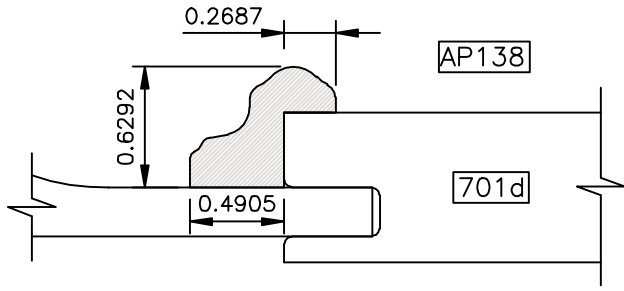

DRAWINGS ARE TO SCALE

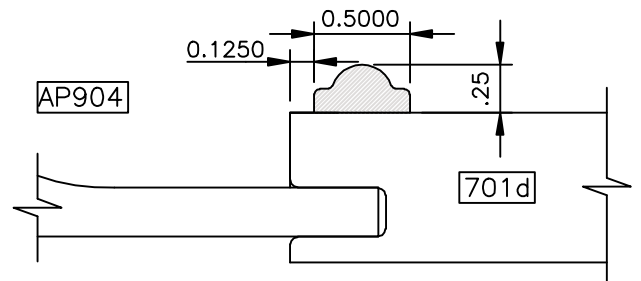
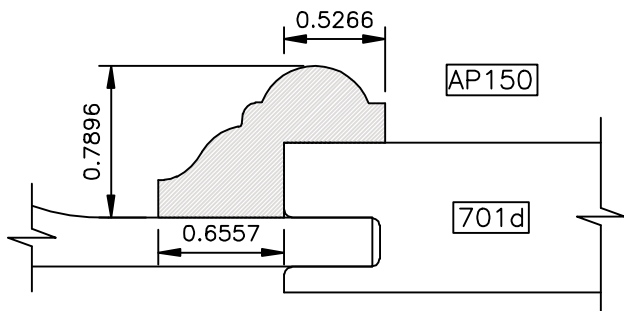
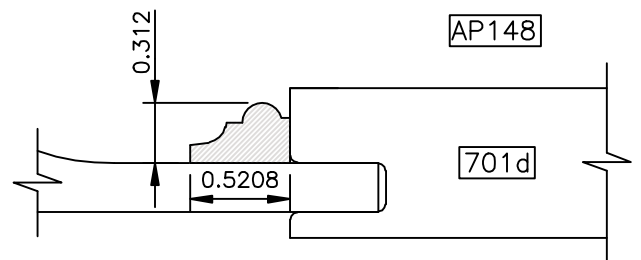
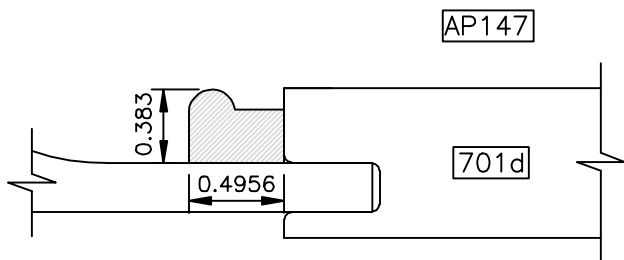
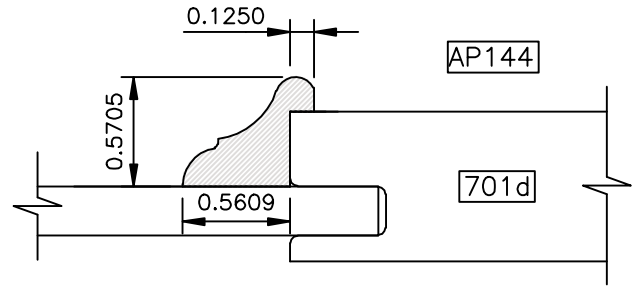
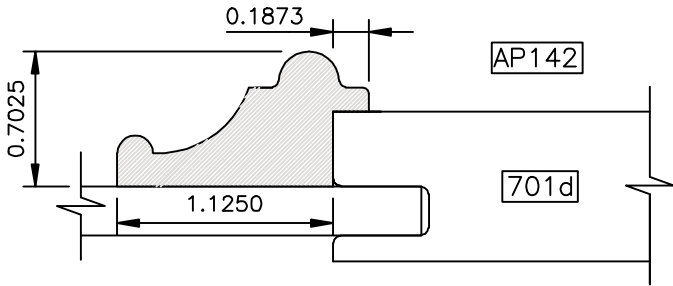

APPLIED MOLDING STYLES

Go West!

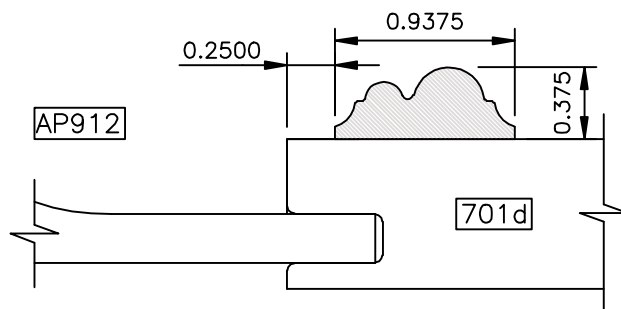
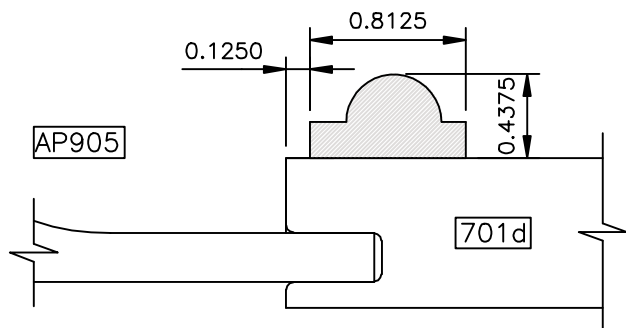

DRAWINGS ARE TO SCALE